

MINI PIVOT MODULE

 Lumenwerx



DUET



BLANK

HLO

PRISM

MICRO-PRISM

DOT

BRIDGE

SOLO



TAB ACOUSTIX

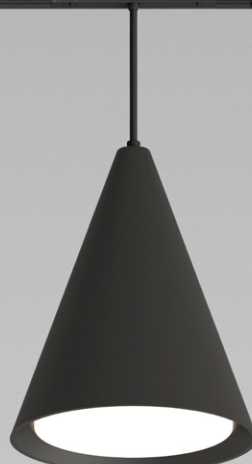

CARET



GLOBE



DOT
CYLINDER



PETITE 1"
CYLINDER

MINI PIVOT MODULE



Project: _____

Type: _____

MINI PIVOT HLO



DESCRIPTION

The Mini Pivot HLO module represents a premium everyday solution with its understated elegance and distribution of clean, uniform light and smooth beam edges.

Order Guide

LUMINAIRE ID	LENGTH	LIGHT SOURCE	CRI	LUMEN PACKAGE	COLOR TEMP.	MODULE FINISH
MIPIVHLO						
MIPIVHLO - Mini Pivot HLO	1FT - 1' 2FT - 2' 3FT - 3' 4FT - 4'	SW - Static white FS - Full spectrum static white	80CRI ¹ - 80+ CRI 90CRI ¹ - 90+ CRI 95CRI - 95+ CRI ¹ Not available with full spectrum.	300LMF - 300 lm/ft 450LMF - 450 lm/ft 600LMF - 600 lm/ft	27K - 2700K 30K - 3000K 35K - 3500K 40K - 4000K	FTMB - Matte black FTMW - Matte white CF# - Custom finish, specify RAL#

Dimensions

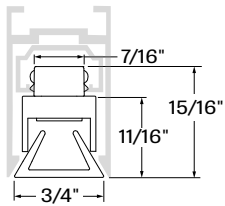

MIPIVHLO - Mini Pivot HLO

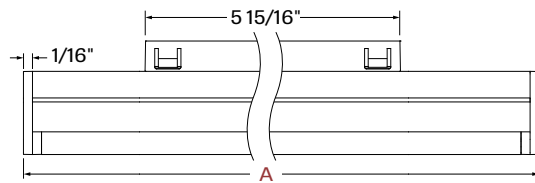

MIPIVHLO - Mini Pivot HLO - Side view

NOMINAL LENGTH	A		WEIGHT	
	TOTAL LENGTH			
1'	11 13/16"		0.2 lb	0.1 kg
2'	23 13/16"		0.4 lb	0.2 kg
3'	35 7/16"		0.7 lb	0.3 kg
4'	47 7/16"		0.9 lb	0.4 kg

Photometrics

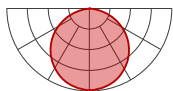

Module wattage (W)

NOMINAL LENGTH	LUMEN PACKAGE at 3500K/80+ CRI		
	300	450	600
1'	4.0	5.9	8.0
2'	7.8	11.1	14.7
3'	11.0	16.6	22.7
4'	14.4	22.2	29.5

Multiplier - CCT/CRI

CCT	Lumens		
	80+ CRI	90+ CRI	95+ CRI
2700K	0.96	0.81	0.80
3000K	0.99	0.83	0.83
3500K	1.00	0.85	0.84
4000K	1.03	0.87	0.86

MINI PIVOT MODULE



Project: _____

Type: _____

MINI PIVOT MICRO-PRISM



DESCRIPTION

The Mini Pivot Micro-Prism module, equipped with our precision Micro-Prism Optic™ (MPO™) is a compact marvel engineered to minimize glare and illuminate gently and powerfully. The module's high-quality light output illuminates with a subtle glow to create pleasant lit environments.

Order Guide

LUMINAIRE ID	LENGTH	LIGHT SOURCE	CRI	LUMEN PACKAGE	COLOR TEMP.	MODULE FINISH
MIPIVMPO						
MIPIVMPO - Mini Pivot Micro-Prism	1FT - 1' 2FT - 2' 3FT - 3' 4FT - 4'	SW - Static white FS - Full spectrum static white	80CRI ¹ - 80+ CRI 90CRI ¹ - 90+ CRI 95CRI - 95+ CRI ¹ Not available with full spectrum.	200LMF - 200 lm/ft 300LMF - 300 lm/ft 400LMF - 400 lm/ft	27K - 2700K 30K - 3000K 35K - 3500K 40K - 4000K	FTMB - Matte black FTMW - Matte white CF# - Custom finish, specify RAL#

Dimensions

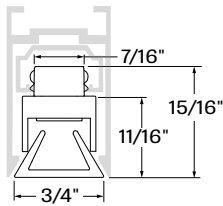

MIPIVMPO - Mini Pivot Micro-Prism

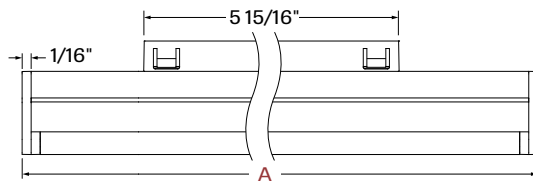

MIPIVMPO - Mini Pivot Micro-Prism - Side view

NOMINAL LENGTH	A		WEIGHT	
	TOTAL LENGTH			
1'	11 13/16"		0.2 lb	0.1 kg
2'	23 13/16"		0.4 lb	0.2 kg
3'	35 7/16"		0.7 lb	0.3 kg
4'	47 7/16"		0.9 lb	0.4 kg

Photometrics

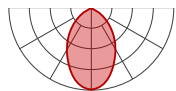

Module wattage (W)

NOMINAL LENGTH	LUMEN PACKAGE at 3500K/80+ CRI		
	200	300	400
1'	4.0	5.9	8.0
2'	7.8	11.1	14.7
3'	11.0	16.6	22.7
4'	14.4	22.2	29.5

Multiplier - CCT/CRI

CCT	Lumens		
	80+ CRI	90+ CRI	95+ CRI
2700K	0.96	0.81	0.80
3000K	0.99	0.83	0.83
3500K	1.00	0.85	0.84
4000K	1.03	0.87	0.86

MINI PIVOT MODULE



Project: _____

Type: _____

MINI PIVOT PRISM

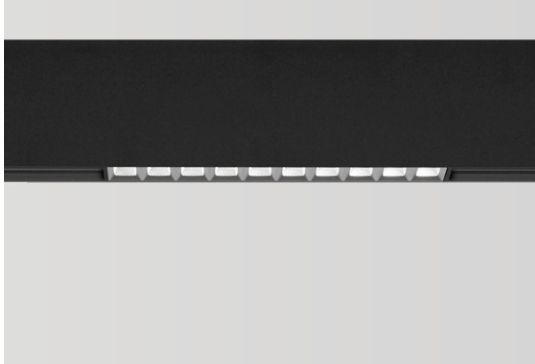

DESCRIPTION

The Mini Pivot Prism module, equipped with our Diamond Prism Optic (DPO), emits a luxurious quality of light, soft and low-glare, wrapping around subjects with subtle graduated shadows.

Order Guide

LUMINAIRE ID	LENGTH	OPTIC	LIGHT SOURCE	CRI
MIPIVPR				
MIPIVPR - Mini Pivot Prism	7IN - 7" (1X10) 14IN - 14" (1X20) 28IN - 28" (1X40)	BDPO - Matte Black Diamond Prism Optic GDPO - Graphite Diamond Prism Optic	SW - Static white FS - Full spectrum static white	80CRI ¹ - 80+ CRI 90CRI ¹ - 90+ CRI 95CRI ² - 95+ CRI ¹ Not available with full spectrum. ² Available with full spectrum only.

LUMEN PACKAGE										COLOR TEMP.	MODULE FINISH
	7" (1X10)			14" (1X20)			28" (1X40)			27K - 2700K 30K - 3000K 35K - 3500K 40K - 4000K	FTMB - Matte black FTMW - Matte white CF# - Custom finish, specify RAL#
	Low	Medium	High	Low	Medium	High	Low	Medium	High		
BDPO	375LM	550LM	X	750LM	1100LM	X	1500LM	2200LM	X		
GDPO	375LM	550LM	750LM	750LM	1100LM	1500LM	1500LM	2200LM	3000LM		

Dimensions

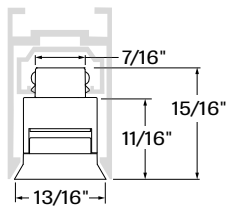

MIPIVPR - Mini Pivot Prism

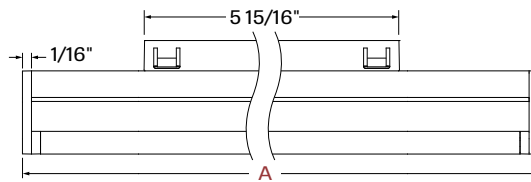

MIPIVPR - Mini Pivot Prism - Side view

NOMINAL LENGTH	A		WEIGHT	
	TOTAL			
7"	6 13/16"		0.13 lb	0.06 kg
14"	13 7/16"		0.26 lb	0.12 kg
28"	26 3/4"		0.53 lb	0.24 kg

MINI PIVOT MODULE



Project: _____

Type: _____

Photometrics

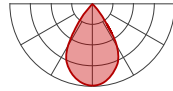
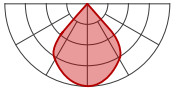

BDPO -
Matte Black Diamond Prism Optic

GDPO -
Graphite Diamond Prism Optic

Module wattage (W) - BDPO

NOMINAL LENGTH	LUMEN PACKAGE at 3500K/90+ CRI	WATTAGE
7" (1X10)	375	6.9 W
	550	10.1 W
14" (1X20)	750	13.9 w
	1100	20.2 W
28" (1X40)	1500	27.7 W
	2200	40.4 W

Module wattage (W) - GDPO

NOMINAL LENGTH	LUMEN PACKAGE at 3500K/90+ CRI	WATTAGE
7" (1X10)	375	5.0 W
	550	6.9 W
	750	10.1 W
14" (1X20)	750	9.5 W
	1100	13.9 W
	1500	20.2 W
28" (1X40)	1500	18.9 W
	2200	27.7 W
	3000	40.4 W

Multiplier - CCT/CRI

CCT	Lumens	
	80+ CRI	90+ CRI
2700K	1.08	0.94
3000K	1.12	0.98
3500K	1.12	1.00
4000K	1.13	1.02

MINI PIVOT MODULE



Project: _____

Type: _____

MINI PIVOT SOLO



DESCRIPTION

The Mini Pivot Solo module highlights separate elements in a space, and in the process, creates a dynamic, harmonious, and aesthetically pleasing atmosphere.

Order Guide

LUMINAIRE ID ¹	LIGHT SOURCE	BEAM	CRI	LUMEN PACKAGE	COLOR TEMP.	MODULE FINISH
MIPIVSOLO	SW			350LM		
MIPIVSOLO - Mini Pivot Solo <small>¹Up to 95° tilt, 355° rotation.</small>	SW - Static white	25DEG - 25° Spot 35DEG - 35° Narrow flood 45DEG - 45° Flood	80CRI - 80+ CRI 90CRI - 90+ CRI	350LM - 350 lm, 5.2 W	27K - 2700K 30K - 3000K 35K - 3500K 40K - 4000K	FTMB - Matte black FTMW - Matte white CF# - Custom finish, specify RAL#

Dimensions

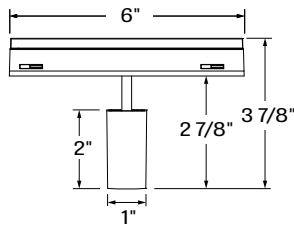

MIPIVSOLO - Mini Pivot Solo

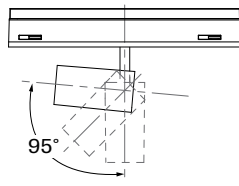

Up to 95° tilt

WEIGHT

0.33 lb	0.15 kg
---------	---------

Photometrics

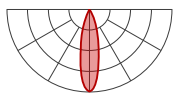

25DEG - 25° Spot

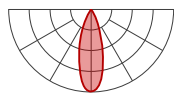

35DEG - 35° Narrow Flood

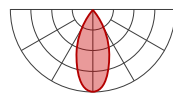

45DEG - 45° Flood

Module wattage (W)

LUMEN PACKAGE at 3500K/80+ CRI	WATTAGE
350	5.2 W

Multiplier - CCT/CRI

CCT	Lumens	
	80+ CRI	90+ CRI
2700K	0.93	0.81
3000K	1.00	0.86
3500K	1.00	0.86
4000K	1.08	0.86



MINI PIVOT MODULE



Project: _____

Type: _____

MINI PIVOT DUET



DESCRIPTION

Mini Pivot Duet, a point source module with twin track heads, allows for lighting in two directions simultaneously with each track head able to tilt up to 70°.

Order Guide

LUMINAIRE ID ¹	LIGHT SOURCE	BEAM	CRI	LUMEN PACKAGE	COLOR TEMP.	MODULE FINISH
MIPIVDUET	SW			700LM		
MIPIVDUET - Mini Pivot Duet <small>¹Up to 70° tilt per head, 355° rotation.</small>	SW - Static white	25DEG - 25° Spot 35DEG - 35° Narrow flood 45DEG - 45° Flood	80CRI - 80+ CRI 90CRI - 90+ CRI	700LM - 700 lm, 10.5 W (350 lm per head)	27K - 2700K 30K - 3000K 35K - 3500K 40K - 4000K	FTMB - Matte black FTMW - Matte white CF# - Custom finish, specify RAL#

Dimensions

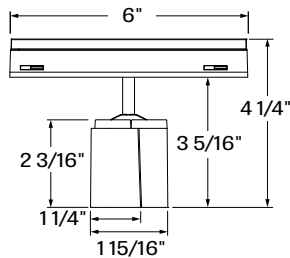

MIPIVDUET - Mini Pivot Duet

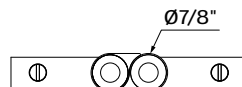

MIPIVDUET - Mini Pivot Duet - Bottom view

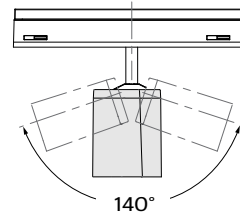

Up to 70° tilt per head

WEIGHT

0.55 lb | 0.25 kg

Photometrics

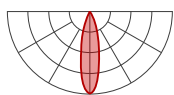

25DEG - 25° Spot

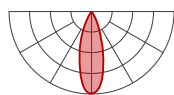

35DEG - 35° Narrow flood

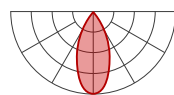

45DEG - 45° Flood

Module wattage (W)

LUMEN PACKAGE at 3500K/80+ CRI	WATTAGE
700	10.5 W

Multiplier - CCT/CRI

CCT	Lumens	
	80+ CRI	90+ CRI
2700K	0.93	0.81
3000K	1.00	0.86
3500K	1.00	0.86
4000K	1.08	0.86



MINI PIVOT MODULE



Project: _____

Type: _____

MINI PIVOT DOT



DESCRIPTION

Mini Pivot Dot modules are individual mounting systems that can be used on their own as single lighting fixtures or as part of a broader design within the Mini Pivot track system.

Order Guide

LUMINAIRE ID ¹	HEIGHT	LIGHT SOURCE	BEAM	CRI	LUMEN PACKAGE ³			COLOR TEMP.
MPIV1DT - Mini Pivot 1.5" Dot MPIV2DT - Mini Pivot 2" Dot <small>¹Up to 90° tilt, 355° rotation.</small>	2.65IN - 2.65"	SW - Static white FS - Full spectrum static white	20DEG - 20° Spot 35DEG - 35° Narrow flood 50DEG - 50° Wide flood	80CRI ² - 80+ CRI 90CRI ² - 90+ CRI 95CRI - 95+ CRI <small>²Not available with full spectrum.</small>		1.5"	2"	27K - 2700K 30K - 3000K 35K - 3500K 40K - 4000K
	2.65" height				700LM - 700 lm, 6 W	750LM - 750 lm, 8.2 W		
	4" height				850LM - 850 lm, 10 W	900LM - 900 lm, 12 W		

³Lumen outputs are reduced with full spectrum, consult factory.

BAFFLE	BAFFLE FINISH	MODULE FINISH
SDB - Standard baffle DCB ⁴ - Decorative baffle <small>⁴Recommended when a different finish is desired for the baffle.</small>	FTMB - Matte black FTMW - Matte white CF# - Custom finish, specify RAL #	FTMB - Matte black FTMW - Matte white CF# - Custom finish, specify RAL#

Photometrics

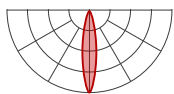

20DEG - 20° Spot

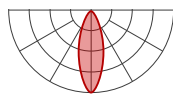

35DEG - 35° Narrow flood

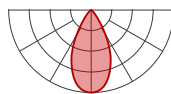

50DEG - 50° Wide flood

Module wattage (W)

SIZE	HEIGHT	LUMEN PACKAGE at 3500K/80+ CRI	WATTAGE
1.5"	2.65"	700	6 W
	4"	850	10 W
2"	2.65"	750	8.2 W
	4"	900	12 W

Multiplier - CCT/CRI

CCT	Lumens		
	80+ CRI	90+ CRI	95+ CRI
2700K	0.94	0.77	0.72
3000K	0.96	0.82	0.75
3500K	1.00	0.85	0.81
4000K	1.02	0.87	0.79



MINI PIVOT MODULE



Project: _____

Type: _____

Dimensions

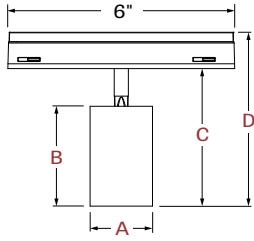

SDB - Standard baffle

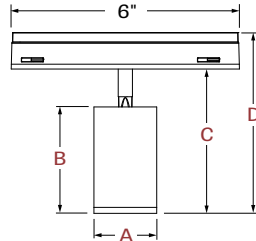

DCB - Decorative baffle

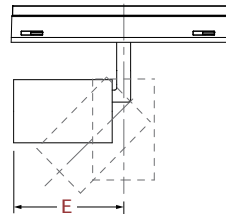

Maximum length - Up to 90° tilt

SIZE	A		B		C		D		E		WEIGHT	
	ACTUAL SIZE	CYLINDER HEIGHT	MODULE HEIGHT	TOTAL HEIGHT	MAX. LENGTH (90° tilt)							
		SDB	DCB	SDB	DCB	SDB	DCB	SDB	DCB			
1.5"	Ø 1 11/16"	2 5/8"	2 13/16"	3 5/8"	3 13/16"	4 5/8"	4 3/4"	2 15/16"	3 1/8"	0.55 lb	0.25 kg	
		4"	4 3/16"	5"	5 3/16"	5 15/16"	6 1/8"	4 5/16"	4 7/16"	0.77 lb	0.35 kg	
2"	Ø 2 3/16"	2 5/8"	2 13/16"	3 5/8"	3 13/16"	4 5/8"	4 3/4"	2 15/16"	3 1/8"	0.66 lb	0.3 kg	
		4"	4 3/16"	5"	5 3/16"	5 15/16"	6 1/8"	4 5/16"	4 7/16"	1.1 lb	0.5 kg	

MINI PIVOT MODULE



Project: _____

Type: _____

MINI PIVOT DOT CYLINDER



DESCRIPTION

Mini Pivot Dot Cylinders are individual mounting systems that can be used on their own as single lighting fixtures or as part of a broader design within the Mini Pivot track system.

Order Guide

LUMINAIRE ID	HEIGHT	LIGHT SOURCE	BEAM	CRI	LUMEN PACKAGE ²		COLOR TEMP.
MPIVIDTCY - Mini Pivot 1.5" Dot Cylinder MPIV2DTCY - Mini Pivot 2" Dot Cylinder	6IN - 6" 9IN - 9" 12IN - 12" 18IN - 18"	SW - Static white FS - Full spectrum static white	20DEG - 20° Spot 35DEG - 35° Narrow flood 50DEG - 50° Wide flood	80CRI ¹ - 80+ CRI 90CRI ¹ - 90+ CRI 95CRI - 95+ CRI ¹ Not available with full spectrum.	1.5"	2"	27K - 2700K 30K - 3000K 35K - 3500K 40K - 4000K
	700LM - 700 lm, 6 W 850LM - 850 lm, 10 W				750LM - 750 lm, 8.2 W 900LM - 900 lm, 12 W	² Lumen outputs are reduced with full spectrum, consult factory.	

BAFFLE	BAFFLE FINISH	MODULE FINISH	SUSPENSION	SUSPENSION LENGTH
SDB - Standard baffle DCB ³ - Decorative baffle ³ Recommended when a different finish is desired for the baffle.	FTMB - Matte black FTMW - Matte white CF# - Custom finish, specify RAL#	FTMB - TMatte black FTMW - Matte white CF# - Custom finish, specify RAL#	PCB - Black power cord PCW - White power cord	12IN - 12" 24IN - 24" 36IN - 36" 48IN - 48"

Photometrics

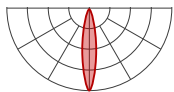

20DEG - 20° Spot

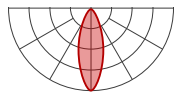

35DEG - 35° Narrow flood

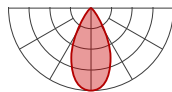

50DEG - 50° Wide flood

Module wattage (W)

SIZE	LUMEN PACKAGE at 3500K/80+ CRI	WATTAGE
1.5"	700	6 W
	850	10 W
2"	750	8.2 W
	900	12 W

Multiplier - CCT/CRI

CCT	Lumens		
	80+ CRI	90+ CRI	95+ CRI
2700K	0.94	0.77	0.72
3000K	0.96	0.82	0.75
3500K	1.00	0.85	0.81
4000K	1.02	0.87	0.79



MINI PIVOT MODULE



Project: _____

Type: _____

Dimensions

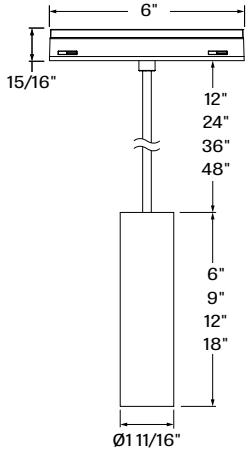

MIPIV1DTCY - Mini Pivot 1.5" Dot Cylinder
- Standard baffle

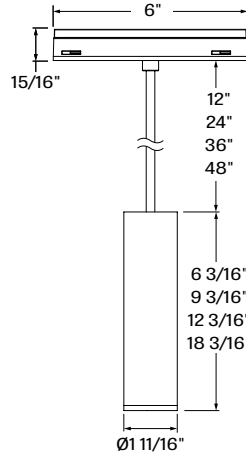

MIPIV1DTCY - Mini Pivot 1.5" Dot Cylinder
- Decorative baffle

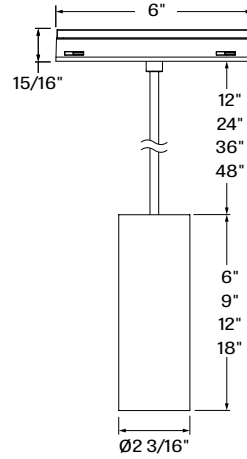

MIPIV2DTCY - Mini Pivot 2" Dot Cylinder
- Standard baffle

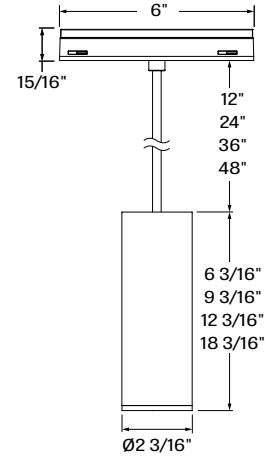

MIPIV2DTCY - Mini Pivot 2" Dot Cylinder
- Decorative baffle

SIZE	HEIGHT	WEIGHT	
1.5"	6"	0.88 lb	0.4 kg
	9"	0.99 lb	0.45 kg
	12"	1.1 lb	0.5 kg
	18"	1.43 lb	0.65 kg
2"	6"	1.21 lb	0.55 kg
	9"	1.43 lb	0.65 kg
	12"	1.54 lb	0.7 kg
	18"	1.87 lb	0.85 kg

MINI PIVOT MODULE



Project: _____

Type: _____

MINI PIVOT PETITE 1" CYLINDER



DESCRIPTION

The Mini Pivot Petite 1" Cylinder is true-to-size, encased in minimalist housing, and elegantly detailed with a slim strain relief and the option of a bevel or glow ring baffle style. Optically, it benefits from our CircaFlex™ beam-splitting technology that allows light to follow an intended optical path with maximal precision, minimal spread, and even distribution.

Order Guide

LUMINAIRE ID	CYLINDER HEIGHT	LIGHT SOURCE	BEAM	CRI	LUMEN PACKAGE ¹	COLOR TEMP.
MIPIVPETICY		SW				
MIPIVPETICY - Mini Pivot Petite 1" Cylinder	6IN - 6" 9IN - 9" 12IN - 12" 18IN - 18"	SW - Static white	35DEG - 35° Narrow flood 45DEG - 45° Flood	80CRI - 80+ CRI 90CRI - 90+ CRI 95CRI - 95+ CRI	580LM - 580 lm, 8 W 670LM - 670 lm, 10 W 780LM - 780 lm, 12 W	27K - 2700K 30K - 3000K 35K - 3500K 40K - 4000K

¹ Refer to the performance tables below for delivered lumens.

BAFFLE STYLE	BAFFLE FINISH Specify NA for Glow ring	MODULE FINISH	SUSPENSION	SUSPENSION LENGTH	LENS
BVL - Bevel GLR - Glow ring	FTMB - Matte black FTMW - Matte white FSPC - Satin silver FSSPC - Matte silver FCHP - Champagne CF# - Custom finish, specify RAL # NA - Not applicable	FTMB - Matte black FTMW - Matte white CF# - Custom finish, specify RAL#	PCB - Black power cord PCW - White power cord	12IN - 12" 24IN - 24" 36IN - 36" 48IN - 48"	SDL - Soft diffused lens, Solite NOL - No lens

MINI PIVOT MODULE



Project: _____

Type: _____

Dimensions

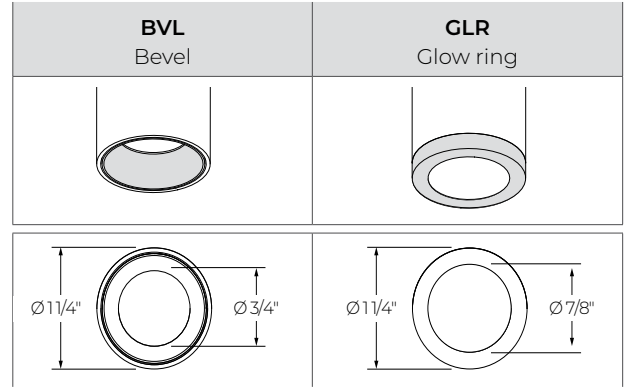
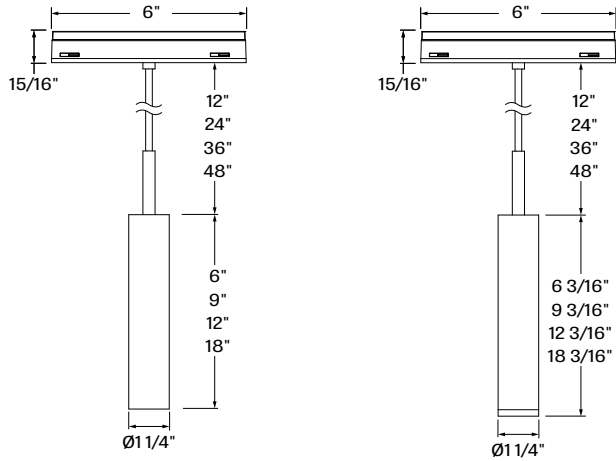

	HEIGHT		WEIGHT	
6"	0.84 lb	0.38 kg		
9"	1.06 lb	0.48 kg		
12"	1.28 lb	0.58 kg		
18"	1.65 lb	0.75 kg		

MIPIVPECTICY - Mini Pivot Petite 1" Cylinder
- Bevel

MIPIVPECTICY - Mini Pivot Petite 1" Cylinder
- Glow ring

Photometrics

Values calculated based on 3500K, 90+ CRI, and with no lens. The light distribution will vary depending on baffle finish and trim style.

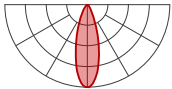

35DEG - 35° Narrow flood

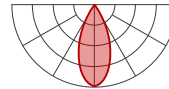

45DEG - 45° Flood

BAFFLE STYLE / FINISH	Im		W		Im		W	
	8 W	10 W	12 W	12 W				
White	549		633		737			
Black, Champagne	447		517		602			
Satin silver, Matte silver	523		604		703			
Glow Ring	555		641		746			

BAFFLE STYLE / FINISH	Im		W		Im		W	
	8 W	10 W	12 W	12 W				
White	582		671		782			
Black, Champagne	470		412		480			
Satin silver, Matte silver	557		643		749			
Glow Ring	560		646		752			

Multipliers

Please follow the multiplier tables to ensure correct lumen value. CCT, CRI, and lensing will change the lumen value.

CCT		CRI		LENS	
2700K	0.94	80+ CRI	1	SDL-Soft diffused lens, Solite	0.91
3000K	0.98	90+ CRI	1	No lens	1
3500K	1	95+ CRI	0.77		
4000K	1.05				

MINI PIVOT MODULE



Project: _____

Type: _____

MINI PIVOT GLOBE



DESCRIPTION

The Mini Pivot Globe offers universal appeal and uniform illumination. The spherical fixture is lit fully with our Isotropic Radiant Optic™ (IRO™) distributing light smoothly and evenly in all directions, thereby avoiding undesirable hotspots.

Order Guide

LUMINAIRE ID	SIZE	OPTIC	LIGHT SOURCE	CRI	LUMEN PACKAGE						
MPIVGLB		IRO	SW								
MPIVGLB - Mini Pivot Globe	4IN - Ø 4" 6IN - Ø 6" 8IN - Ø 8"	IRO - Isotropic Radiant Optic	SW - Static white	80CRI - 80+ CRI 90CRI - 90+ CRI 95CRI - 95+ CRI	<table border="1"> <tr> <td>Ø 4"</td> <td>300LM - 300 lm, 6 W</td> </tr> <tr> <td>Ø 6"</td> <td>600LM - 600 lm, 14.4 W</td> </tr> <tr> <td>Ø 8"</td> <td>900LM - 900 lm, 19.1 W</td> </tr> </table>	Ø 4"	300LM - 300 lm, 6 W	Ø 6"	600LM - 600 lm, 14.4 W	Ø 8"	900LM - 900 lm, 19.1 W
Ø 4"	300LM - 300 lm, 6 W										
Ø 6"	600LM - 600 lm, 14.4 W										
Ø 8"	900LM - 900 lm, 19.1 W										

COLOR TEMP.	MODULE FINISH	SUSPENSION	SUSPENSION LENGTH
27K - 2700K 30K - 3000K 35K - 3500K 40K - 4000K	FTMB - Matte black FTMW - Matte white CF# - Custom finish, specify RAL#	PCB - Black power cord PCW - White power cord	12IN - 12" 24IN - 24" 36IN - 36" 48IN - 48"

Photometrics

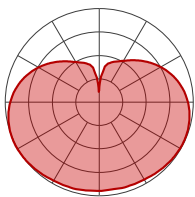

Dimensions

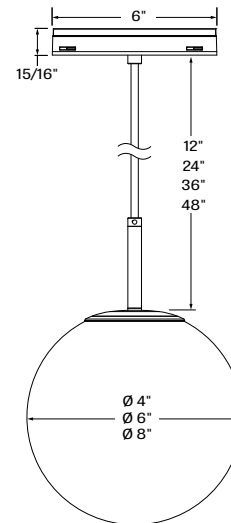

SIZE	WEIGHT	
4"	1.1 lb	0.5 kg
6"	1.8 lb	0.8 kg
8"	2.6 lb	1.2 kg

Module wattage (W)

SIZE	LUMEN PACKAGE at 3500K/80+ CRI	WATTAGE
4"	300	6 W
6"	600	14.4 W
8"	900	19.1 W

Multiplier - CCT/CRI

CCT	Lumens		
	80+ CRI	90+ CRI	95+ CRI
2700K	0.94	0.77	0.72
3000K	0.96	0.82	0.75
3500K	1.00	0.85	0.81
4000K	1.02	0.87	0.79

MINI PIVOT MODULE



Project: _____

Type: _____

MINI PIVOT CARET



DESCRIPTION

Timeless in appearance and flexible in function, the conical Mini Pivot Caret embodies the simple decorative beauty of geometric design and the sophisticated power of innovative technology. The Caret is equipped with our Unity Pointed (UP) technology, which delivers lens brightness uniformity.

Order Guide

LUMINAIRE ID	SIZE	OPTIC	LIGHT SOURCE	CRI	LUMEN PACKAGE ²
MIPIVCAR	8IN	HLO			
MIPIVCAR - Mini Pivot Caret	8IN - Ø 8"	HLO - High-Efficiency Lambertian Optic	SW - Static white FS - Full spectrum static white	80CRI ¹ - 80+ CRI 90CRI ¹ - 90+ CRI 95CRI - 95+ CRI	500LM - 500 lm, 5.6 W 700LM - 700 lm, 7.7 W
¹ Not available with full spectrum.					
² Lumen outputs are reduced with full spectrum, consult factory.					

COLOR TEMP.	INNER TRIM FINISH	MODULE FINISH	SUSPENSION	SUSPENSION LENGTH
27K - 2700K 30K - 3000K 35K - 3500K 40K - 4000K	FTMB - Matte black FTMW - Matte white CF# - Custom finish, specify RAL#	FTMB - Matte black FTMW - Matte white CF# - Custom finish, specify RAL#	PCB - Black power cord PCW - White power cord	12IN - 12" 24IN - 24" 36IN - 36" 48IN - 48"

Photometrics

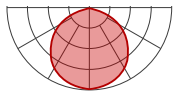

Module wattage (W)

SIZE	LUMEN PACKAGE at 3500K/90+ CRI	WATTAGE
8"	500	5.6 W
	700	7.7 W

Multiplier - CCT/CRI

CCT	Lumens		
	80+ CRI	90+ CRI	95+ CRI
2700K	1.13	0.94	0.88
3000K	1.17	0.96	0.90
3500K	1.19	1.00	0.92
4000K	1.19	1.00	0.94

Dimensions

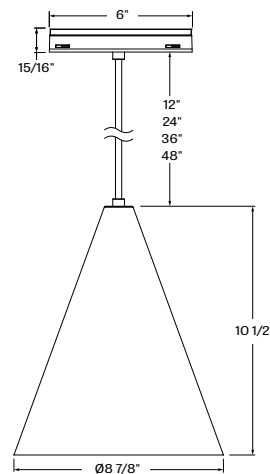

MIPIVCAR - Mini Pivot Caret Ø 8"

SIZE		WEIGHT	
8"		2.2 lb	1 kg

MINI PIVOT MODULE



Project: _____

Type: _____

MINI PIVOT TAB ACOUSTIX



DESCRIPTION

Mini Pivot Tab Acoustix is an acoustic pendant that delivers quality light, effective acoustic control, a touch of softness with its rounded corners, and a punch of color thanks to its sound-absorbing felt panel (made from PET resin) available in a variety of standard and premium colors.

Order Guide

LUMINAIRE ID	DISTRIBUTION	OPTIC	LIGHT SOURCE	CRI	LUMEN PACKAGE
MIPIVTABACO	D	HLO	SW	90CRI	250LMF
MIPIVTABACO - Mini Pivot Tab Acoustix	D - Direct	HLO - High-Efficiency Lambertian Optic	SW - Static white	90CRI - 90+ CRI	250LMF - 250 lm/ft

COLOR TEMP.	LUMINAIRE LENGTH	LUMINAIRE HEIGHT	MODULE FINISH	SUSPENSION	SUSPENSION LENGTH
		8IN			
27K - 2700K 30K - 3000K 35K - 3500K 40K - 4000K	2FT - 2' 3FT - 3' 4FT - 4'	8IN - 8"	FTMB - Matte black FTMW - Matte white CF# - Custom finish, specify RAL#	PCB - Black power cord PCW - White power cord	12IN - 12" 24IN - 24" 36IN - 36" 48IN - 48"

FELT COLOR

STANDARD COLORS	PREMIUM COLORS ^{1,2}																										
<table border="0"> <tr> <td> FWN</td> <td> LVN</td> </tr> <tr> <td> FON</td> <td> LEN</td> </tr> <tr> <td> ION</td> <td> CYN</td> </tr> <tr> <td> TBN</td> <td> PMN</td> </tr> <tr> <td> MDN</td> <td> FGN</td> </tr> </table>	FWN	LVN	FON	LEN	ION	CYN	TBN	PMN	MDN	FGN	<table border="0"> <tr> <td> PKN</td> <td> CDN</td> <td> IVN</td> <td> BHN</td> </tr> <tr> <td> OGN</td> <td> SYN</td> <td> SLN</td> <td> MON</td> </tr> <tr> <td> LNN</td> <td> BLN</td> <td> CNN</td> <td></td> </tr> <tr> <td> LMN</td> <td> NVN</td> <td> GHN</td> <td></td> </tr> </table>	PKN	CDN	IVN	BHN	OGN	SYN	SLN	MON	LNN	BLN	CNN		LMN	NVN	GHN	
FWN	LVN																										
FON	LEN																										
ION	CYN																										
TBN	PMN																										
MDN	FGN																										
PKN	CDN	IVN	BHN																								
OGN	SYN	SLN	MON																								
LNN	BLN	CNN																									
LMN	NVN	GHN																									

¹Please consult factory for more color options.
²Lead time may vary.



MINI PIVOT MODULE



Project: _____

Type: _____

Dimensions

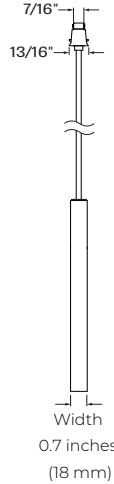
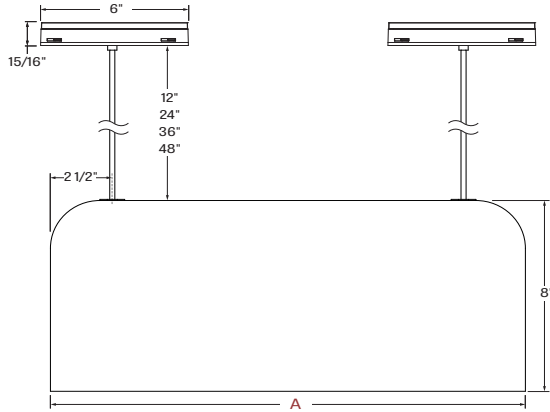

MIPIVTABACO - Mini Pivot Tab Acoustix

MIPIVTABACO - Mini Pivot Tab Acoustix - side view



MIPIVTABACO - Mini Pivot Tab Acoustix - bottom view

NOMINAL LENGTH	A FIXTURE LENGTH	B DIRECT LENS LENGTH	WEIGHT	
2'	22 7/8"	21 5/8"	1.65 lb	0.75 kg
3'	34 7/8"	33 5/8"	2.43 lb	1.1 kg
4'	46 7/8"	45 5/8"	3.3 lb	1.5 kg

Photometrics

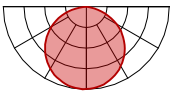

Module wattage (W)

NOMINAL LENGTH	LUMEN PACKAGE at 3500K/90+ CRI	WATTAGE
2'	500	12.6 W
3'	750	24.6 W
4'	1000	33.2 W

Multiplier - CCT/CRI

CCT	Lumens 90+ CRI
2700K	1.02
3000K	1.01
3500K	1.00
4000K	0.98

MINI PIVOT MODULE



Project: _____

Type: _____

Standard Color Options



FWN - FROST WHITE

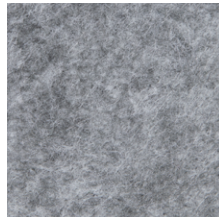

FON - FOG

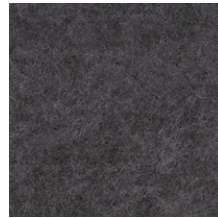

ION - IRON



TBN - TRUE BLACK



MDN - MIDNIGHT BLUE



LVN - LAVENDER



LEN - LATTE



CYN - CHERRY



PMN - PLUM



FGN - FOREST GREEN

Premium Color Options*



PKN - PAPRIKA



OGN - ORANGE



LNN - LEMON



LMN - LIME



CDN - CLOUDY



SYN - SKY



BLN - BLUEBERRY



NVN - NAVY



IVN - IVORY



SLN - STEEL



CNN - CARBON

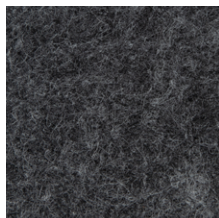

GHN - GRAPHITE



BHN - BLUSH



MON - MOCHA

*Please consult factory for more color options.

*Lead time may vary.

MINI PIVOT MODULE



Project: _____

Type: _____

MINI PIVOT BRIDGE



DESCRIPTION

The Mini Pivot Bridge is a connector module mounted across two tracks and designed to tap into Mini Pivot's electrical system. In this way, the Bridge serves as a powered track on which additional luminaire modules can be placed.

Order Guide

LUMINAIRE ID	LENGTH	MODULE FINISH
MIPIVBGE		
MIPIVBGE - Mini Pivot Bridge	#FT#IN ¹ - Specify nominal length (#) in 1" and/or 1" increments ¹ Minimum length is 2'. Maximum length is 8'.	FTMB - Matte black FTMW - Matte white CF# - Custom finish, specify RAL#

Dimensions

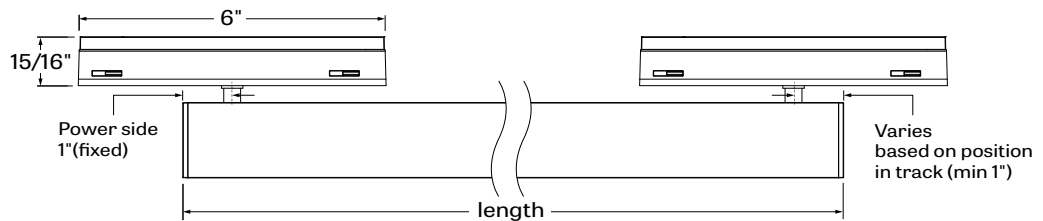
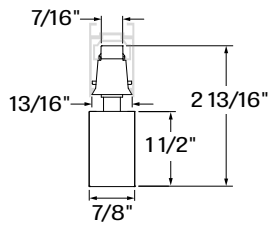

MIPIVBGE - Mini Pivot Bridge

MIPIVBGE - Mini Pivot Bridge - Side view

Bridge wattage

The Mini Pivot Bridge module shares power with an adjoining track section (via the power side adapter). In order to determine the rated wattage per foot of a track section + bridge, you must first calculate the rated wattage of the track section powering the bridge (8 W/ft x length) then divide that wattage by the total length of that section + the length of the bridge module attached to it.

Track with Bridge

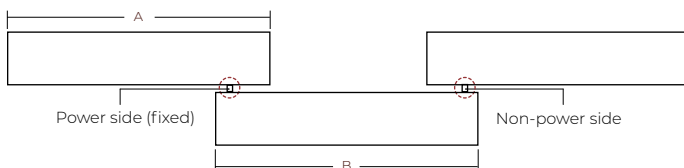

Example:

Track length [A] = 8 ft

Bridge length [B] = 4 ft

Track wattage (W) = 8 W/ft x 8 ft = 64 W

Track + bridge wattage per foot (W/ft) = 64 W / [8 ft + 4 ft] = 5.3 W/ft

LENGTH	WEIGHT	
2'	1.43 lb	0.65 kg
3'	2.05 lb	0.93 kg
4'	2.65 lb	1.20 kg
5'	3.26 lb	1.48 kg
6'	3.86 lb	1.75 kg
7'	4.48 lb	2.03 kg
8'	5.07 lb	2.30 kg

MINI PIVOT MODULE



Project: _____

Type: _____

MINI PIVOT BLANK



DESCRIPTION

The Mini Pivot Blank modules are unlit modules that click securely into the bottom of the Mini Pivot Track system. Their purpose is to mask unlit track modules with their smooth, unassuming appearance.

Order Guide

LUMINAIRE ID	LENGTH	MODULE FINISH
MIPIVBLA		
MIPIVBLA - Mini Pivot Blank	#FT#IN ¹ - Specify nominal length (#) in 1' and/or 1" increments <small>¹Minimum length is 1". Maximum length is 8'.</small>	FTMB - Matte black FTMW - Matte white CF# - Custom finish, specify RAL#

Dimensions

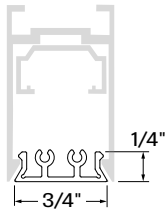

LENGTH	WEIGHT (per ft.)	
1'	1 lb	0.45 kg

MIPIVBLA - Mini Pivot Blank

Technical Specifications

OPTICS

High-Efficiency Lambertian Optic (HLO)

Shielding of diffusing 0.075" thick acrylic provides up to 88% transmission and good obscuration. Matte white reflectors distribute LED output across the shielding. Luminaire brightness is controlled by the ratio of luminous flux to shielding area.

Micro-Prism Optic™ (MPO™)

The Micro-Prism Optic™ uses a unique lens that mixes refraction and reflection. Its micro prism and efficient design minimize light loss while maintaining visual comfort and low glare.

Diamond Prism Optic (DPO)

The Diamond Prism Optic™ (DPO™) is our patent-pending 3-tiered optic meticulously crafted to refract and reflect beams with great precision, effectively keeping glare to a minimum while delivering light of exceptional quality and visual comfort.

Mini Pivot Solo and Duet Optic

The Mini Pivot Solo and Duet modules use an LED light source coupled with a TIR refractor to provide three beam angles of 25°, 35°, and 45°, while producing up to 350 lumens.

CircaFlex™ Optic

The CircaFlex™ Optic, at just 0.8" for Mini Pivot Petite Cylinder and 1.2" for Mini Pivot Dot/Dot Cylinder, uses advanced beam-splitting technology to allow light to follow an intended optical path with maximal precision, minimal spread, and even distribution.

Isotropic Radiant Optic™ (IRO™)

The Isotropic Radiant Optic™ (IRO™) is a spherical lens designed with a spike-textured surface through which light rays are diffused outward and equally in all directions.

LIGHT SOURCE

Static white

LEDs are available in 2700K, 3000K, 3500K and 4000K with a choice of 80+ CRI, 90+ CRI, or 95+ CRI, with elevated R9 value for 90+ CRI and above. Color consistency is maintained to within 2 SDCM. All LEDs have been tested in accordance with IESNA LM-80-08 and the results have shown L80 lumen maintenance greater than 60,000 hours. Absolute product photometry is measured and presented in accordance with IESNA LM-79, unless otherwise indicated.

Full spectrum static white

The full spectrum LED option offers improved color particularly in the cyan region that is beneficial in both healthcare and circadian lighting strategies. The cyan region in full spectrum LED is richer at the 480 nm range.

LOCKING MECHANISM

Lightweight, the Mini Pivot Prism, HLO, and Blanks modules easily lock into place on the system track with a simple click. All other modules are secured with a secondary screw-locking mechanism for added protection.



Linear Modules



Accent Modules

CERTIFICATION

ETL: Rated for indoor dry locations. Conforms to UL Standard 1574 and certified to CAN/CSA Standard C22.2 No. 250.0.

WARRANTY

Lumenwerx provides a five-year limited warranty on electrical and mechanical performance of the luminaires, including the LED boards, drivers, and auxiliary electronics. Lumenwerx will repair or replace defective luminaires or components at our discretion, provided they have been installed and operated in accordance with our specifications. Other limitations apply, please refer to the full warranty on our website.