

AERA 4" DOWNLIGHT

SQUARE RECESSED
NEW CONSTRUCTION & REMODEL

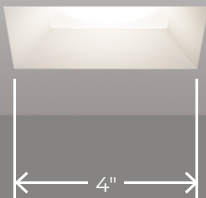

Bevel Trimless
Drywall Mudplate



Bevel
Flanged Trim

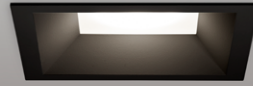

Aera recessed downlights are true to size, encased in minimalist housing, and suitable additions to any interior space where outstanding optical performance, maximal eye comfort, and/or an industry-leading wall wash are required.

Ceiling Types



Drywall



Millwork



Wood Slat
Consult factory



Acoustic Tile

Installation Types

New Construction (Type Non-IC, Type-IC, CCEA)
Remodel (Type Non-IC)

Plenum Clearance



Beam Angles



Low UGR < 10 in 10°, 15°, 25°, 35°, and 50° beams

Performance

LUMEN OUTPUT ¹	WATTS	EFFICACY
1481 lm	14 W	106 lm/W
2066 lm	20 W	103 lm/W
2775 lm	28 W	99 lm/W

¹Lumen packages are assuming 3500K, 80+ CRI, 35° beam, with SDL lens option.

Light Source

Static White
Full Spectrum Static White
SOLA - Dim-to-Warm
DUO - Tunable White



COB

2 Step Color Binning
Up to 95+ CRI

Drivers / Protocols

1%, 0.1% Dimming Available
0-10V, TRIAC, ELV, Lutron EcoSystem, DALI, DMX
Emergency Battery (optional)



Smart / Wireless Compatible

Aera Family (Refer to other spec sheets) Downlight



2" / 3" / 4"
Round / Square
Recessed Adjustable



2" / 3" / 4"
Round / Square
Recessed



2" / 3" / 4"
Round / Square
Recessed Wall Wash

Multi-aperture



2" / 3" / 4"
Round / Square
Recessed Adjustable



2" / 3" / 4"
Round / Square
Recessed



2" / 3" / 4"
Round / Square
Recessed Wall Wash

Cylinder



2" / 3" / 4" / 5" / 6"
4" Seal
Pendant
Pendant Asymmetric
Pendant Wall Wash



2" / 3" / 4" / 5" / 6"
4" Seal
Wall
Wall Asymmetric



2" / 3" / 4" / 5" / 6"
4" Seal
Surface
Surface Asymmetric
Surface Wall Wash

www.lumenwerx.com
T (514) 225-4304

© Lumenwerx, ULC. All rights reserved.



Lumenwerx reserves the right to modify
product specifications without notification.

AERA4-DOWNLIGHT-SQUARE-RECESSED-SPEC-REV8 December 31, 2025

AERA 4" DOWNLIGHT

SQUARE RECESSED
NEW CONSTRUCTION & REMODEL



Project: _____
Type: _____

Order Guide

1 - Housing (Example: AE4SR-TRM-SW-OF-ASB-120V-14W-D1-NA)



For a Title 24 JA8 compliant fixture, see page 3.

LUMINAIRE ID ¹	TRIM STYLE	LIGHT SOURCE	INSTALLATION TYPE	MOUNTING OPTION ⁴
AE4SR				
AE4SR - Aera 4" Square Recessed ¹ Recessed Adjustable and Recessed Wall Wash also available. Consult other spec sheets.	TRM - Flanged trim TLMP - Trimless drywall mudplate TLMW ² - Trimless millwork ² For remodel (RM) installation type, TLMW adapter must be installed from above the ceiling or before ceiling is installed.	SW - Static white FS - Full spectrum static white SOLA - Dim-to-warm single channel control DUO - Tunable white 2-channel control	OF - Open Frame Type Non-IC IC ³ - Type-IC RM - Remodel Type Non-IC CP ³ - Chicago Plenum Type-IC (CCEA) AT ³ - Airtight Type-IC ³ Only available with 20 W or less.	ASB ⁵ - Adjustable standard bar hangers FMB ⁵ - Flush mount bars ACB ⁵ - Adjustable commercial bar hangers AHC ⁵ - Adjustable hat channel bars NA - No bar hangers ⁴ See page 5 for more details. ⁵ Not available with RM installation type.
VOLTAGE	WATTAGE ⁷	DIMMING ¹⁰	OPTION ²¹	
			NA	
120V - 120V 277V - 277V UNV - 120V-277V 347V ⁶ - 347V ⁶ Available with RD1 driver only. Please consult factory.	14W - 14 W output, up to 1538 lm 20W - 20 W output, up to 2146 lm 28W ^{8,9} - 28 W output, up to 2882 lm ⁷ Lumen outputs are reduced with full spectrum, consult factory. ⁸ Not available with IC/CP/AT. ⁹ Not available with full spectrum. SOLA ⁸ 14W - 14 W output, up to 937 lm 18W - 18 W output, up to 1205 lm 28W - 28 W output, up to 1945 lm DUO ⁸ 14W - 14 W output, up to 1005 lm 19W - 19 W output, up to 1364 lm 28W - 28 W output, up to 2055 lm	INTEGRAL D1 - 1% 0-10V ELV ¹¹ - ELV 120V TRI ¹¹ - TRIAC 120V LDE1 ^{12,13} - Lutron Hi-lume 1% Eco DA ^{12,13} - DALI ELD1 ¹² - eldoLED 1% ECOdrive 0-10V ELDO ¹² - eldoLED 0.1% SOLOdrive 0-10V PEQO ^{13,14,15} - Lutron Hi-lume Premier 0.1% EcoSystem DEB ¹⁵ - 0-10V with onboard emergency battery backup ¹⁰ PoE (Power-over-Ethernet) compatible. Consult factory for details. ¹¹ Available with 120V only. ¹² Not available with RM installation type. ¹³ On-site commissioning is required. ¹⁴ Not available with 28 W output. ¹⁵ Available with OF housing only.	REMOTE ¹⁶ RD1 - 1% 0-10V RELV ¹⁷ - ELV 120V RTRI ¹⁷ - TRIAC 120V RLDE1 ¹⁸ - Lutron Hi-lume 1% Eco RDA ¹⁸ - DALI RELD1 - eldoLED 1% ECOdrive 0-10V RELD0 - eldoLED 0.1% SOLOdrive 0-10V RPEQO ^{18,19} - Lutron Hi-lume Premier 0.1% EcoSystem +EB ²⁰ - Emergency battery ¹⁶ A remote driver box is provided. ¹⁷ Available with 120V only. ¹⁸ On-site commissioning is required. ¹⁹ Not available with 28 W output. ²⁰ To specify, add +EB to the selected dimming option, e.g. 1C+EB.	NA - None ²¹ To specify a JA8 compliant fixture, see page 3.

2 - Light & Baffle (Example: AE4SRB-SW-14W-15DEG-2STP-90CRI-27K-LSDL+LS-TRM-CL-FTMW-FTMW-NA)

LUMINAIRE ID	LIGHT SOURCE Specify same as Housing	WATTAGE ²² Specify same as Housing	BEAM	COLOR QUALITY	CRI	COLOR TEMP.
AE4SRB						
AE4SRB - Aera 4" Square Recessed Bevel	SW - Static white FS - Full spectrum static white SOLA - Dim-to-warm single channel control DUO - Tunable white 2-channel control	14W - 14 W output, up to 1538 lm 20W - 20 W output, up to 2146 lm 28W ^{23,24} - 28 W output, up to 2882 lm ²² Lumen outputs are reduced with full spectrum, consult factory. ²³ Not available with IC/CP/AT. ²⁴ Not available with full spectrum. SOLA ²³ 14W - 14 W output, up to 937 lm 18W - 18 W output, up to 1205 lm 28W - 28 W output, up to 1945 lm DUO ²³ 14W - 14 W output, up to 1005 lm 19W - 19 W output, up to 1364 lm 28W - 28 W output, up to 2055 lm	10DEG - 10° Very narrow spot 15DEG - 15° Narrow spot 25DEG - 25° Spot 35DEG - 35° Narrow flood 50DEG - 50° Wide flood 80DEG - 80° Very wide flood 90DEG - 90° Open flood 25DEG - 25° Spot 35DEG - 35° Narrow flood 60DEG - 60° Wide flood 80DEG - 80° Very wide flood 90DEG - 90° Open flood	2STP ²⁵ - 2 Step MacAdam Ellipse 3STP - 3 Step MacAdam Ellipse ²⁵ Not available with full spectrum.	80CRI ²⁶ - 80+ CRI 90CRI ²⁶ - 90+ CRI 95CRI - 95+ CRI ²⁶ Not available with full spectrum.	22K ²⁷ - 2200K 24K ²⁸ - 2400K 27K - 2700K 30K - 3000K 35K - 3500K 40K - 4000K 50K ²⁸ - 5000K ²⁷ Only available with 90+ CRI. ²⁸ Not available with 95+ CRI.

ACCESSORIES *	TRIM STYLE Specify same as Housing	LENS *	BAFFLE FINISH	TRIM FLANGE FINISH Specify NA for Bevel Trimless	OPTION ³³
At light element ^{29,30} (choose up to 2 options for SW/FS and 1 option for SOLA/DUO) LSDL - Soft diffused lens, Solite LFDL - Frosted diffused lens LS - Linear spread HEX ³¹ - Hex louver NA - None ²⁹ Separate codes with a "+" if more than one is specified, e.g. LSDL+LS. ³⁰ LSDL and LFDL cannot be combined. LS and HEX cannot be combined. ³¹ Not available with 80°/90° beam options.	TRM - Flanged trim TLMP - Trimless drywall mudplate TLMW ³² - Trimless millwork ³² For remodel (RM) installation type, TLMW adapter must be installed from above the ceiling or before ceiling is installed.	At baffle (choose 1 option) SDL - Soft diffused lens, Solite FDL - Frosted diffused lens CL - Clear lens NOL - No lens	FTMW - Matte white FTMB - Matte black FSPC - Satin silver FSSPC - Matte silver FCHP - Champagne FDBZ - Dark bronze FPF - Primer finish CF# - Custom finish, specify RAL#	FTMW - Matte white FTMB - Matte black FSPC - Satin silver FSSPC - Matte silver FCHP - Champagne FDBZ - Dark bronze FPF - Primer finish CF# - Custom finish, specify RAL# NA - Not applicable	WET ³⁴ - Wet location NA - None ³³ To specify a JA8 compliant fixture, see page 3. ³⁴ Must be specified with the flanged trim (TRM), and either SDL, FDL, or CL lens options.

* LSDL or LFDL at light element cannot be combined with SDL or FDL at baffle.

www.lumenwerx.com
T (514) 225-4304

© Lumenwerx, ULC. All rights reserved.



Lumenwerx reserves the right to modify product specifications without notification.

AERA4-DOWNLIGHT-SQUARE-RECESSED-SPEC-REV8 December 31, 2025

AERA 4" DOWNLIGHT



SQUARE RECESSED
NEW CONSTRUCTION & REMODEL
Title 24 JA8
Order Guide

Project: _____
Type: _____



1 - Housing (Example: AE4SR-TRM-SW-AT-ASB-120V-14W-D1-JA8)

LUMINAIRE ID ¹	TRIM STYLE	LIGHT SOURCE	INSTALLATION TYPE	MOUNTING OPTION ²
AE4SR		SW	AT	
AE4SR - Aera 4" Square Recessed ¹ Recessed Adjustable and Recessed Wall Wash also available. Consult other spec sheets.	TRM - Flanged trim TLMP - Trimless drywall mudplate TLMW - Trimless millwork	SW - Static white	AT - Airtight Type-IC	ASB - Adjustable standard bar hangers FMB - Flush mount bars ACB - Adjustable commercial bar hangers AHC - Adjustable hat channel bars NA - None ² See page 5 for more details.

VOLTAGE	WATTAGE	DIMMING		OPTION
	14W			JA8
120V - 120V 277V - 277V UNV - 120V-277V	14W - 14 W output, up to 1538 lm	INTEGRAL D1 - 1% 0-10V ELV ³ - ELV 120V TRI ³ - TRIAC 120V LDE1 ⁴ - Lutron Hi-lume 1% Eco ³ Available with 120V only. ⁴ On-site commissioning is required.	REMOTE ⁵ RDI - 1% 0-10V RELV ⁶ - ELV 120V RTRI ⁶ - TRIAC 120V RLDE1 ⁷ - Lutron Hi-lume 1% Eco ⁵ A remote driver box is provided. ⁶ Available with 120V only. ⁷ On-site commissioning is required.	JA8 - JA8 compliant

2 - Light & Baffle (Example: AE4SRB-SW-14W-15DEG-2STP-90CRI-27K-NA-TRM-SDL-FTMW-FTMW-JA8+WET)

LUMINAIRE ID	LIGHT SOURCE Specify same as Housing	WATTAGE Specify same as Housing	BEAM	COLOR QUALITY	CRI	COLOR TEMP.
AE4SRB	SW	14W			90CRI	
AE4SRB - Aera 4" Square Recessed Bevel	SW - Static white	14W - 14 W output, up to 1538 lm	15DEG - 15° Narrow spot 25DEG - 25° Spot 35DEG - 35° Narrow flood 50DEG - 50° Wide flood 80DEG - 80° Very wide flood 90DEG - 90° Open flood	2STP - 2 Step MacAdam Ellipse 3STP - 3 Step MacAdam Ellipse	90CRI - 90+ CRI	27K - 2700K 30K - 3000K 35K - 3500K 40K - 4000K

ACCESSORY * See page 6 for details	TRIM STYLE Specify same as Housing	LENS * See page 6 for details	BAFFLE FINISH	TRIM FLANGE FINISH Specify NA for Bevel Trimless	OPTIONS
					JA8
At light element LSDL - Soft diffused lens, Solite LFDL - Frosted diffused lens NA - None	TRM - Flanged trim TLMP - Trimless drywall mudplate TLMW - Trimless millwork	At baffle SDL - Soft diffused lens, Solite FDL - Frosted diffused lens CL - Clear lens NOL - No lens	FTMW - Matte white FTMB - Matte black FSPC - Satin silver FSSPC - Matte silver FCHP - Champagne FDBZ - Dark bronze FPF - Primer finish CF# - Custom finish, specify RAL#	FTMW - Matte white FTMB - Matte black FSPC - Satin silver FSSPC - Matte silver FCHP - Champagne FDBZ - Dark bronze FPF - Primer finish CF# - Custom finish, specify RAL# NA - Not applicable	JA8 - JA8 compliant WET ^{8,9} - Wet location ⁸ Must be specified with the flanged trim (TRM), and either SDL, FDL, or CL lens options. ⁹ To specify the WET option, the code will be JA8+WET.

* LSDL or LFDL at light element cannot be combined with SDL or FDL at baffle.



AERA 4" DOWNLIGHT



SQUARE RECESSED
NEW CONSTRUCTION & REMODEL

Housing

INSTALLATION TYPES		
OF - Open Frame Type Non-IC	IC - Type-IC	CP - Chicago Plenum Type-IC (CCEA) AT - Airtight Type-IC
RM - Remodel Type Non-IC		
Integral	Remote	

- For height dimension C, see the PLENUM CLEARANCE & CUT-OUT DIMENSIONS table below.
- For OF, IC, CP, and AT installation types with remote dimming, a remote driver box is provided.
- Clearance between sides of luminaire and parts of building must be 1/2" minimum; clearance to insulating materials to be 3" minimum, unless luminaires are IC rated.

PLENUM CLEARANCE & CUT-OUT DIMENSIONS

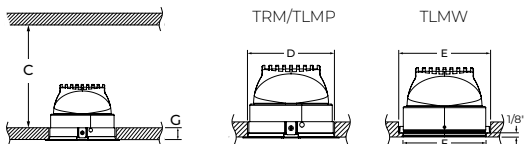

PLENUM CLEARANCE HEIGHT		
REMOTE & INTEGRAL		
	D1/ELV/TRI	LDE1/DA/ELDI/ELDO/PEQ0
C	OF	4 1/8"
	IC	4" (14 W) 6 3/8" (20 W)
	CP/AT	4 7/8" (14 W) 6 7/8" (20 W)
	RM	4 1/8"
CUT-OUT DIMENSIONS		
D	TRM/TLMP	4 1/2" x 4 1/2"
E	TLMW	4 1/2" x 4 1/2"
F	TLMW	4 1/16" x 4 1/16" with 1/8" lip
MAXIMUM CEILING THICKNESS		
G	TRM/ TLMP	1 3/8"
	TLMW	5/8"

AERA 4" DOWNLIGHT



SQUARE RECESSED
NEW CONSTRUCTION & REMODEL

Housing

MOUNTING OPTIONS

ASB - Adjustable Standard Bar Hangers

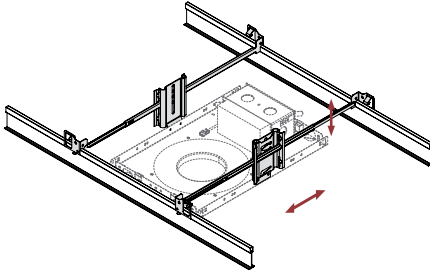

Adjustable Standard Bar hangers can be used in both commercial and residential applications and are adjustable to various heights in both Grid Ceiling and Drywall mounting. ASB hangers are less rigid and versatile than ACB hangers.

FMB - Flush Mount Bars

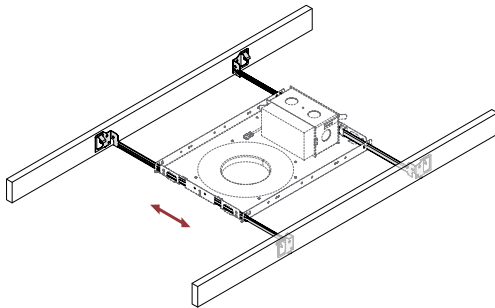

Flush Mount Bars are best used in residential applications, fitting snug to the surface and suitable for Wood, Metal, and Drywall mounting. The flush mounted bars are static and can't be adjusted.

ACB - Adjustable Commercial Bar Hangers

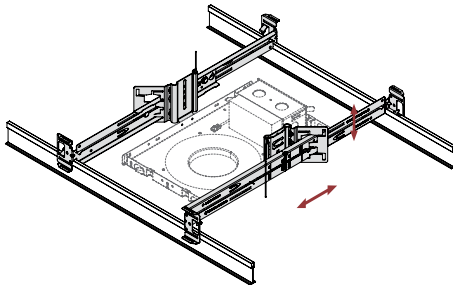

Adjustable Commercial Bar hangers can be used in both commercial and residential applications and are by far the most versatile mounting bar we offer with its adjustability to various heights. ACB hangers are suitable for Grid Ceiling, Drywall, Metal, Wood and Frame mounting.

- Extremely rigid
- Fits into C-Channel notches in a Butterfly Bracket

AHC - Adjustable Hat Channel Bars

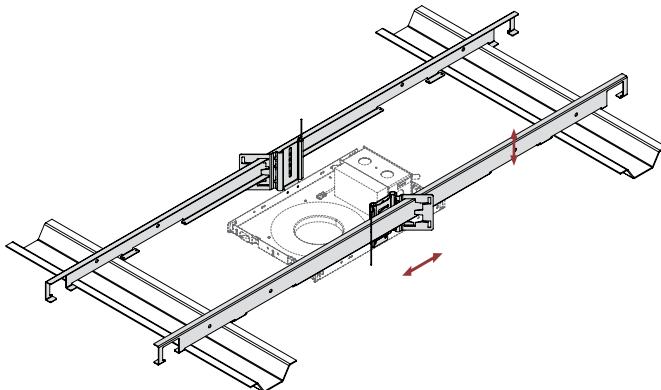

Adjustable Hat Channel bars can be used in both commercial and residential applications and come with a butterfly clip to adjust to various heights. AHC bars can be hung downward by 90 degrees in vertical position, and once wired, can be shifted onto the horizontal mounting plane. AHC bars are suitable for both Drywall and wood ceiling applications.

AERA 4" DOWNLIGHT

SQUARE RECESSED
NEW CONSTRUCTION & REMODEL



Light & Baffle

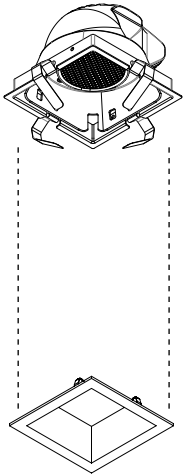

Flanged
Trim

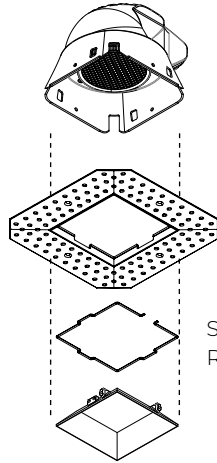

Trimless
Drywall
Mudplate

Mudplate
OD - 6 7/8" x 6 7/8"

Spring
Ring

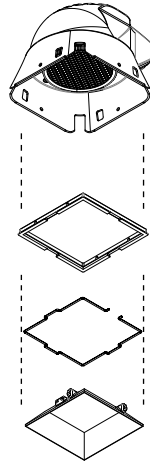

Trimless
Millwork

Millwork
Adapter

Spring
Ring

LENS AND ACCESSORIES

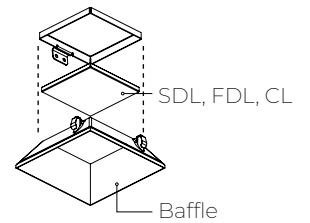
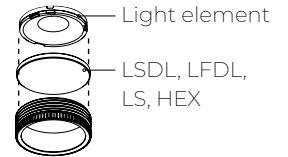

Bevel	
TRM Flanged Trim	TLMP/TLMW Trimless Drywall Mudplate /Trimless Millwork
<p>■ Baffle finish</p> <p>■ Trim flange finish</p>	

AERA 4" DOWNLIGHT

SQUARE RECESSED
NEW CONSTRUCTION & REMODEL



Finishes

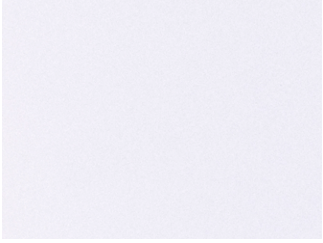

FTMW - Matte white



FTMB - Matte black



FSPC - Satin silver



FSSPC - Matte silver



FCHP - Champagne

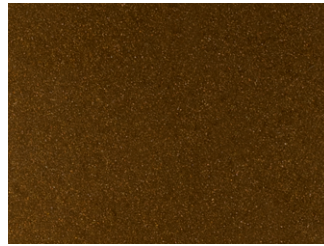

FDBZ - Dark bronze

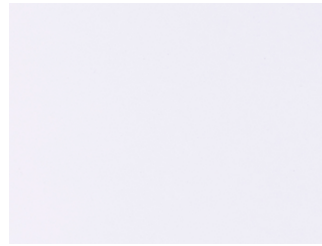

FPF - Primer finish

AERA 4" DOWNLIGHT



SQUARE RECESSED
NEW CONSTRUCTION & REMODEL

Color Quality

COLOR QUALITY - 3500K	
TM-30 R _r	90
TM-30 R _g	100
CRI	90+
R9	> 50

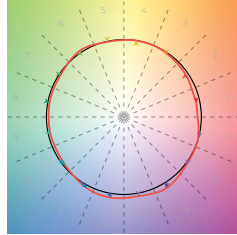

Photometrics

STATIC WHITE

Values calculated based on 3500K, bevel baffle, and SDL lens option.

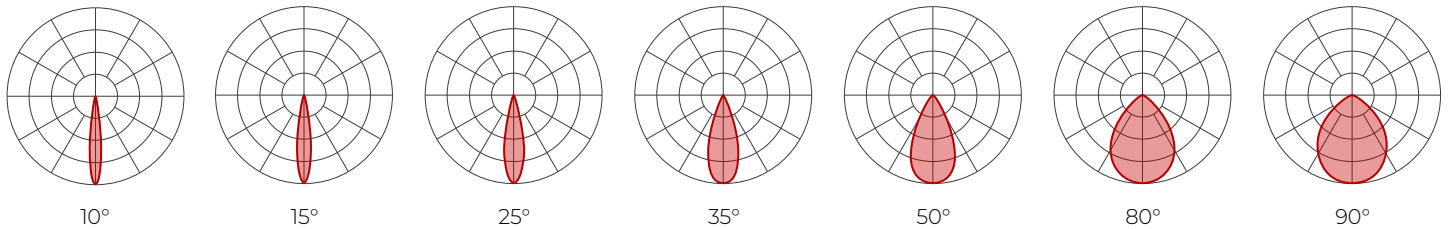

Delivered lumens (LM)

CRI	80+ CRI							90+ CRI							95+ CRI						
	10°	15°	25°	35°	50°	80°	90°	10°	15°	25°	35°	50°	80°	90°	10°	15°	25°	35°	50°	80°	90°
14 W	1347	1497	1538	1481	1451	1306	1306	1259	1399	1437	1384	1356	1220	1220	969	1077	1106	1066	1044	940	940
20 W	1880	2089	2146	2066	2026	1823	1823	1757	1952	2006	1931	1893	1704	1704	1353	1503	1545	1487	1458	1312	1312
28 W	2524	2804	2882	2775	2719	2447	2447	2359	2621	2693	2593	2541	2287	2287	1816	2018	2074	1997	1957	1761	1761

Efficacy (LM/W)

CRI	80+ CRI							90+ CRI							95+ CRI						
	10°	15°	25°	35°	50°	80°	90°	10°	15°	25°	35°	50°	80°	90°	10°	15°	25°	35°	50°	80°	90°
14 W	96	107	110	106	104	93	93	90	100	103	99	97	87	87	69	77	79	76	75	67	67
20 W	94	104	107	103	101	91	91	88	98	100	97	95	85	85	68	75	77	74	73	66	66
28 W	90	100	103	99	97	87	87	84	94	96	93	91	82	82	65	72	74	71	70	63	63

MULTIPLIERS

Please follow the multiplier tables to ensure correct lumen value. Beams, CCT, baffle styles, baffle colors, lensing and accessories will change the lumen value.

CCT		BAFFLE STYLE AND COLOR		LENS * (At baffle)		ACCESSORIES * (At light element)	
2200K	0.80	Flanged trim	1	SDL - Soft diffused lens, Solite	1	LSDL - Soft diffused lens, Solite	1
2400K	0.87	Trimless	1	FDL - Frosted lens	0.8	LFDL - Frosted lens	0.8
2700K	0.94	Bevel	1	CL - Clear lens	1.1	LS - Linear spread	0.84
3000K	0.98	Wet bevel	1	NOL - No lens	1.1	HEX - Hex louver	0.86
3500K	1	White	1				
4000K	1.05	Black	1				
5000K	1.05						

* When more than one lens or accessory is specified, multiply together the value of each lens and/or accessory.
e.g. NOL + LSDL + LS = 1.1 x 1 x 0.84 = 0.924

For SOLA and DUO, please consult factory.



AERA 4" DOWNLIGHT

SQUARE RECESSED NEW CONSTRUCTION & REMODEL



Technical Specifications

OPTIC

XPoint™ Refraction Technology optics provide precise optical control in a remarkably compact form. Micro optical paths from the chip on board converge and then disperse in precise beam angles, resulting in a crisp and exacting light quality.

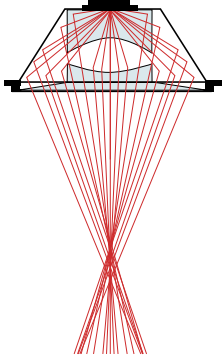

LIGHT SOURCE

Static white

Compact COB (Chip-On-Board) LED module, available in 2200K, 2400K, 2700K, 3000K, 3500K, 4000K, and 5000K with a choice of 80+ CRI, 90+ CRI, or 95+ CRI, with elevated R9 value for 90+ CRI and above. Color consistency is maintained to within 2 SDCM. All LEDs have been tested in accordance with IESNA LM-80-08 and the results have shown L80 lumen maintenance greater than 60,000 hours. Absolute product photometry is measured and presented in accordance with IESNA LM-79, unless otherwise indicated.

Full spectrum static white

The full spectrum LED option offers improved color particularly in the cyan region that is beneficial in both healthcare and circadian lighting strategies. The cyan region in full spectrum LED is richer at the 480 nm range.

Chromawerx SOLA

Chromawerx SOLA is single-channel control that dims output while warming the color temperature in a pre-determined relationship. Two color temperature range options are offered: 3000K to 1800K, and 2700K to 1800K. A simple analog control adjusts a specially populated LED array to emulate the effect of dimming a filament source.

Chromawerx DUO

Chromawerx DUO offers a two-channel control system which uses analog or digital protocols for synchronous control of both cool to warm LED arrays - maintaining a CRI above 90. Two color temperature range options are offered: 6500K to 2700K, and 5000K to 2700K. The range of color DUO offers is useful for entraining circadian rhythms, stimulating alertness, and compensating for jet lag among other applications. The Chromawerx drivers are programmed to limit maximum light output and power usage across all color temperatures. When paired with DALI drivers (DDA/DDA8), color tuning follows a linear dimming curve.

ELECTRICAL

Unless otherwise specified, dimming down to 1%. At maximum driver load: efficiency > 84%, PF > 0.9, THD < 20%.

ELV and TRIAC dimming performance (including minimum dimming percentage) subject to dimmer selection.

Integral: 0-10V, ELV, TRIAC, Lutron Hi-Lume 1% EcoSystem, DALI, eldoLED 0.1% SOLOdrive 0-10V, eldoLED 1% ECOdrive 0-10V, DMX, Lutron DALI-2 digital

Remote: 0-10V, ELV, TRIAC, Lutron Hi-Lume 1% EcoSystem, DALI, eldoLED 0.1% SOLOdrive 0-10V, eldoLED 1% ECOdrive 0-10V, DMX, Lutron DALI-2 digital

Emergency battery options - Integral: Factory installed, long-life, high-temperature, LED driver with integrated emergency backup using a recyclable LiFePO₄ battery pack. Features a remote test switch with charge indicator, minimum of 90 minutes operation and 10 W per downlight emergency lighting output. Recharge time of 12 hours.

Emergency battery options - Remote: Remotely-installed, long-life, high-temperature, maintenance-free, Bodine Lithium-Ion battery pack with self-test functionality, test switch and charge indicator. IOTA and Fulham options available upon request. Minimum of 90 minutes operation, and recharge time of 24 hours. For fixtures less than 10 W, the battery provides 6 W of emergency light output. For fixtures 10 W and over, the battery provides 10 W.

PoE

Depending on the PoE manufacturer selected, Lumenwerx will install the node in factory as either integral to the luminaire or as a remote module. Factory programming of the PoE node may or may not enable the following functionalities: lumen package, DUO (tunable white), QUADRO (RGBW), emergency battery backup, and sensor integration. These must be addressed and evaluated on a case-by-case basis.

AERA 4" DOWNLIGHT



SQUARE RECESSED NEW CONSTRUCTION & REMODEL

CONSTRUCTION

Housing

For new construction, 20 gauge powder coated steel. Open frame, type-IC, or Chicago Plenum (CCEA) rated. 18 gauge galvanized steel junction box with ½" trade size knockouts. Adjustable standard, flush mount, adjustable commercial, and adjustable hat channel bar hangers are available as mounting options.

Light element

LED module: Integral COB module. 90+ CRI and 2 SDCM, Standard with options of 80+ CRI, or 95+ CRI. L80 > 60,000 hours.

XPoint™ Refraction Technology optic: Micro optical paths from the chip on board converge and then disperse in precise beam angles, resulting in a crisp and exacting light quality.

Thermal management: Die-cast aluminum heat sink to maximize thermal dissipation.

Baffle: Die-cast aluminum mounted with retaining spring clips

Trim style: Trimmed and trimless with mudplate or millwork adapter

Finish: Matte white, matte black, satin silver, matte silver, champagne, dark bronze, and primer finish. Custom colors also available (provide RAL #). For the primer finish option, fixture must be turned off and the lens masked before applying paint.

WEIGHT

Open frame: 4.5 lbs - 2 kg

Type-IC/Chicago Plenum: 8 lbs - 3.6 kg

Remodel: 3.5 lbs - 1.6 kg

LENS AND ACCESSORIES



Soft diffused lens, Solite



Frosted diffused lens



Clear lens



Linear spread



Hex Louver

ENVIRONMENT

Ambient temperature at fixture location shall be within 0°C/32°F - 25°C/77°F, indoor dry or damp as well as outdoor damp use (canopies or marquees).

CERTIFICATIONS

ETL: Rated for indoor dry/damp locations. Conforms to UL Standard 1598 and certified to CAN/CSA Standard C22.2 No. 250.0.

IP44: IP44 rated for bathrooms, showers, outdoor canopies, and marquees when specified with the wet location (WET) option.

Chicago Plenum: City of Chicago approved (CCEA) when specified with CP installation type option.

IC rated: Suitable for direct contact with insulation when specified with IC, CP or AT installation type options.

Title 24 JAB: California Building Standards Code

Declare: [LBC Red List Approved](#)