

AERA 5" CYLINDER

WALL

DIRECT/INDIRECT, DIRECT, INDIRECT



Declare.



6" Height
Bevel



8" Height
Bevel



12" Height
Pinhole

True-to-size with a versatile minimalist esthetic, Aera Cylinder luminaires are high-performance fixtures, delivering visually comfortable lighting suitable for a wide range of applications.

Distributions



Direct Direct Indirect
/Indirect

Mounting Options



Flat Direct

Beam Angles



Low UGR < 10 in 10°, 15°, 25°, 35°, and 50° beams

Performance

LUMEN OUTPUT ¹	WATTS	EFFICACY
1481 lm	14 W	106 lm/W
2066 lm	20 W	103 lm/W
2775 lm	28 W	99 lm/W
3163 lm	32 W	99 lm/W

¹ Lumen packages are assuming 3500K, 80+ CRI, 35° beam, bevel baffle, SDL lens option.

Light Source

Static White
Full Spectrum Static White
SOLA - Dim-to-Warm
DUO - Tunable White



COB

2 Step Color Binning
Up to 95+ CRI

Drivers / Protocols

1%, 0.1% Dimming Available
0-10V, TRIAC, ELV, Lutron EcoSystem, DALI, DMX
Emergency Battery (optional)



Smart / Wireless Compatible

Aera Family (Refer to other spec sheets)

Downlight



2" / 3" / 4"
Round / Square
Recessed Adjustable



2" / 3" / 4"
Round / Square
Recessed



2" / 3" / 4"
Round / Square
Recessed Wall Wash

Multi-aperture



2" / 3" / 4"
Round / Square
Recessed Adjustable



2" / 3" / 4"
Round / Square
Recessed



2" / 3" / 4"
Round / Square
Recessed Wall Wash

Cylinder



2" / 3" / 4" / 5" / 6"
4" Seal
Pendant
Pendant Asymmetric
Pendant Wall Wash



2" / 3" / 4" / 5" / 6"
4" Seal
Wall
Wall Asymmetric
Surface Asymmetric
Surface Wall Wash



2" / 3" / 4" / 5" / 6"
4" Seal
Surface
Surface Asymmetric
Surface Wall Wash

www.lumenwerx.com
T (514) 225-4304

© Lumenwerx, ULC. All rights reserved.



Lumenwerx reserves the right to modify product specifications without notification.
AERAS-CYLINDER-WALL-SPEC-REV5 January 12, 2026

AERA 5" CYLINDER

WALL

DIRECT/INDIRECT, DIRECT, INDIRECT



Project: _____

Type: _____

Order Guide

LUMINAIRE ID	DISTRIBUTION	CYLINDER HEIGHT ¹		CYLINDER FINISH	BAFFLE STYLE	BAFFLE FINISH	LENS * See page 3 for details	
AE5CYW								
AE5CYW - Aera 5" Cylinder Wall	DI - Direct/Indirect D - Direct I - Indirect	DIRECT/INDIRECT 8IN ² - 8" 12IN - 12" 14IN - 14"	DIRECT OR INDIRECT 6IN ² - 6" 8IN - 8" 12IN - 12" 14IN - 14"	FTMW - Matte white FTMB - Matte black FCHP - Champagne FDBZ - Dark bronze CF# - Custom finish, specify RAL#	BVL - Bevel PHL - Pinhole	FTMW - Matte white FTMB - Matte black FSPC - Satin silver FSSPC - Matte silver FCHP - Champagne FDBZ - Dark bronze CF# - Custom finish, specify RAL#	At baffle (choose 1 option) Specify NOL for Pinhole SDL - Soft diffused lens, Solite FDL - Frosted diffused lens CL - Clear lens NOL - No lens	
		¹ For minimum heights, see dimensions on page 3. ² Available with remote driver only.						
LIGHT SOURCE	DIRECT BEAM Specify NA for Indirect	INDIRECT BEAM Specify NA for Direct	COLOR QUALITY	CRI	COLOR TEMPERATURE		ACCESSORIES * See page 3 for details	VOLTAGE
SW - Static white FS - Full spectrum	10DEG - 10° Very narrow spot 15DEG - 15° Narrow spot 25DEG - 25° Spot 35DEG - 35° Narrow flood 50DEG - 50° Wide flood 80DEG - 80° Very wide flood 90DEG - 90° Open flood NA - Not applicable	25DEG - 25° Spot 35DEG - 35° Narrow flood 60DEG - 60° Wide flood 80DEG - 80° Very wide flood 90DEG - 90° Open flood NA - Not applicable	25TP ³ - 2 Step MacAdam Ellipse 35TP - 3 Step MacAdam Ellipse ³ Not available with full spectrum.	80CRI ⁴ - 80+ CRI 90CRI ⁴ - 90+ CRI 95CRI - 95+ CRI ⁴ Not available with full spectrum.	22K ⁵ - 2200K 24K ⁶ - 2400K 27K - 2700K 30K - 3000K	35K - 3500K 40K - 4000K 50K ⁶ - 5000K	At light element ^{7,8} (choose up to 2 options for SW/FS and 1 option for SOLA/DUO) LSDL - Soft diffused lens, Solite LFDL - Frosted diffused lens LS - Linear spread HEX ^{9,10} - Hex louver NA - None	120V - 120V 277V - 277V UNV - 120V-277V 347V ¹¹ - 347V ¹¹ Available with RD1 driver only. Please consult factory.
SOLA - Dim-to-warm single channel control DUO - Tunable white 2-channel control	25DEG - 25° Spot 35DEG - 35° Narrow flood 60DEG - 60° Wide flood 80DEG - 80° Very wide flood 90DEG - 90° Open flood NA - Not applicable	35DEG - 35° Narrow flood 60DEG - 60° Wide flood 80DEG - 80° Very wide flood 90DEG - 90° Open flood NA - Not applicable	35TP - 3 Step MacAdam Ellipse	90CRI - 90+ CRI	SOLA 30K18K - 3000K to 1800K 27K18K - 2700K to 1800K DUO 65K27K - 6500K to 2700K 50K27K - 5000K to 2700K		⁷ Separate codes with a "+" if more than one is specified, e.g. LSDL+LS. ⁸ LSDL and LFSDL cannot be combined. LS and HEX cannot be combined. ⁹ Not available with 80°/90° beam options. ¹⁰ Not available with 32 W output.	

* LSDL or LFSDL at light element cannot be combined with SDL, FDL, or CL at baffle.

DIRECT WATTAGE ¹² Specify NA for Indirect	INDIRECT WATTAGE ¹² Specify NA for Direct	DIMMING ¹⁹	
14W - 14 W output, up to 1538 lm 20W - 20 W output, up to 2146 lm 28W ^{13,14,15} - 28 W output, up to 2882 lm 32W ^{13,15,16} - 32 W output, up to 3285 lm NA - Not applicable ¹² Lumen outputs are reduced with full spectrum, consult factory. ¹³ Not available with full spectrum. ¹⁴ Not available with integral drivers for a Direct/Indirect fixture. ¹⁵ Not available with 32 W indirect wattage. ¹⁶ Not available with integral drivers. ¹⁷ Not available for a Direct/Indirect fixture. ¹⁸ Not available with 32 W direct wattage.	14W - 14 W output, up to 1538 lm 20W - 20 W output, up to 2146 lm 28W ^{13,14,18} - 28 W output, up to 2882 lm 32W ^{13,16,18} - 32 W output, up to 3285 lm NA - Not applicable	INTEGRAL DI - 1% 0-10V ELV ²⁰ - ELV 120V TRI ²⁰ - TRIAC 120V ¹⁹ PoE (Power-over-Ethernet) compatible. Consult factory for details. ²⁰ Available with 120V only.	REMOTE ²¹ RD1 - 1% 0-10V RELV ²² - ELV 120V RTRI ²² - TRIAC 120V RLDE1 ²³ - Lutron Hi-lume 1% Eco RDA ²³ - DALI ²¹ A remote driver box is provided. ²² Available with 120V only. ²³ On-site commissioning is required. ²⁴ To specify, add +EB to the selected dimming option, e.g. RD1+EB. RELD1 - eldoLED 1% ECOdrive 0-10V RELD0 - eldoLED 0.1% SOLOdrive 0-10V +EB ²⁴ - Emergency battery
SOLA 18W - 18 W output, up to 1205 lm 28W ¹⁴ - 28 W output, up to 1945 lm DUO 14W - 14 W output, up to 1005 lm 20W - 20 W output, up to 1435 lm 28W ¹⁷ - 28 W output, up to 2055 lm NA - Not applicable	SOLA 18W - 18 W output, up to 1205 lm 28W ¹⁴ - 28 W output, up to 1945 lm DUO 14W - 14 W output, up to 1005 lm 20W - 20 W output, up to 1435 lm 28W ¹⁷ - 28 W output, up to 2055 lm NA - Not applicable	SOLA SDI - Single 0-10V input SELV ²⁰ - ELV 120V STRI ²⁰ - TRIAC 120V	SOLA RSDI - Single 0-10V input RSELV ²² - ELV 120V RSTRI ²² - TRIAC 120V DUO RDMX ²³ - DMX RDDA ²³ - DALI DT6 RDDA8 ²³ - DALI DT8 RDD1 - Dual 0-10V input for CCT/intensity RLD2 ²³ - Lutron DALI-2 digital +EB ²⁴ - Emergency battery

ELECTRICAL	CANOPY TYPE	CANOPY FINISH Specify NA for Direct
1C - 1 circuit 2C ²⁵ - 2 circuits ²⁵ Available with Direct/Indirect and remote driver only.	FLS - Flat square canopy, 4" octagonal junction box DM - Direct mount	FTMW - Matte white FTMB - Matte black FCHP - Champagne FDBZ - Dark bronze CF# - Custom finish, specify RAL# NA - Not applicable

www.lumenwerx.com
T (514) 225-4304

© Lumenwerx, ULC. All rights reserved.



Lumenwerx reserves the right to modify product specifications without notification.
AERA5-CYLINDER-WALL-SPEC-REV5 January 12, 2026

AERA 5" CYLINDER

WALL

DIRECT/INDIRECT, DIRECT, INDIRECT



Dimensions

CYLINDER

Direct/Indirect ¹

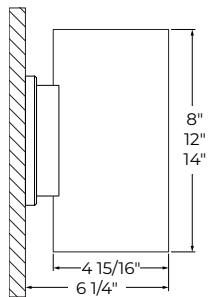

Flat square canopy ²

Direct ¹

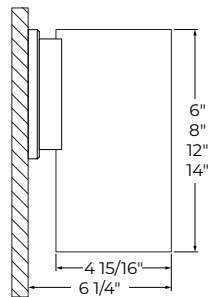

Flat square canopy ²

Indirect ¹

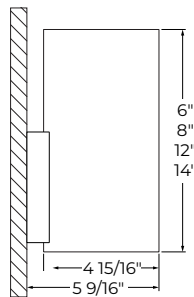

Direct mount ²

¹Certain restrictions apply. See page 2 for the height options available with integral and remote.

²Flat square canopy and direct mount options are available with all Direct/Indirect, Direct and Indirect.

Lens and Accessories

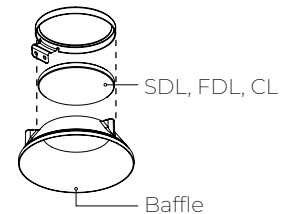
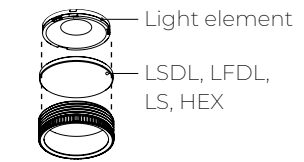

Minimum heights - Cylinder

Size	Distribution	Integral driver	Remote driver
Ø 5"	Direct/Indirect	12"	8"
	Direct or Indirect	8"	6"

¹Consult factory for maximum heights.

BAFFLE

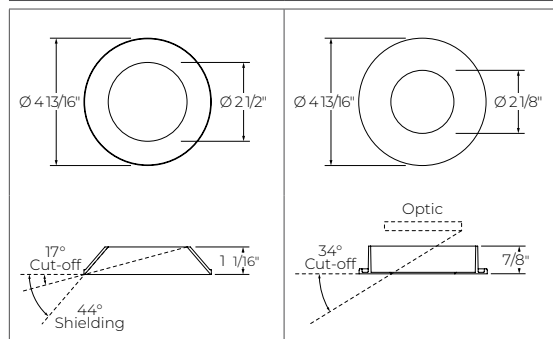
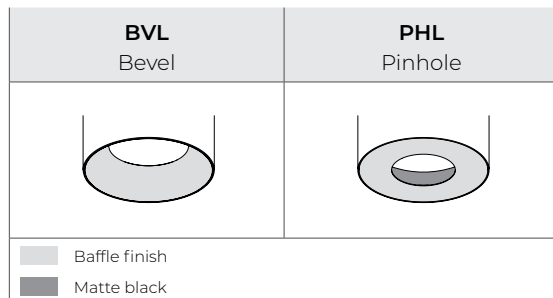

AERA 5" CYLINDER



WALL

DIRECT/INDIRECT, DIRECT, INDIRECT

Finishes

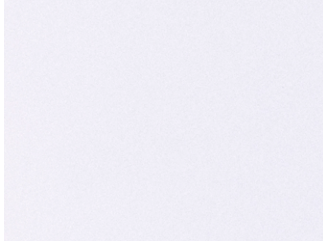

FTMW - Matte white



FTMB - Matte black



FSPC - Satin silver

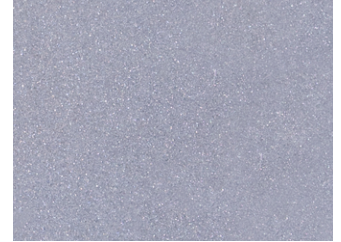

FSSPC - Matte silver



FCHP - Champagne



FDBZ - Dark bronze

Mounting

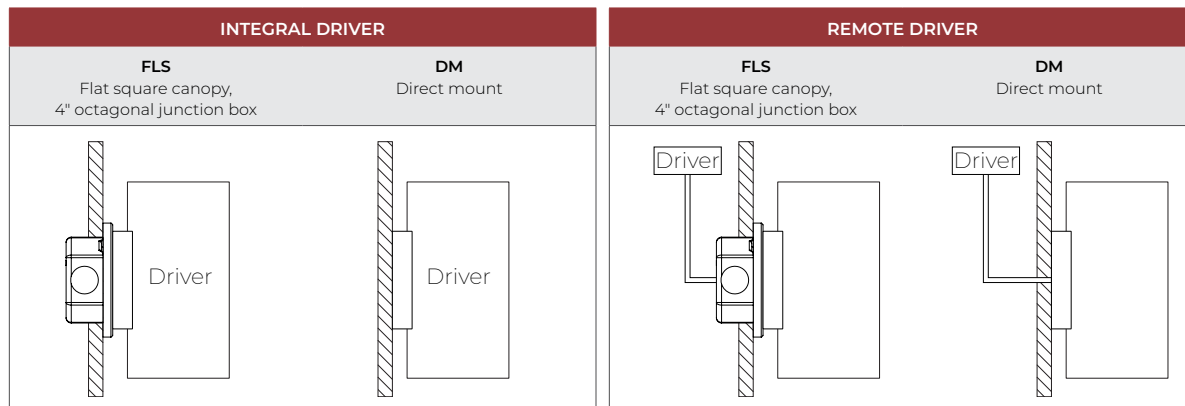

AERA 5" CYLINDER



WALL

DIRECT/INDIRECT, DIRECT, INDIRECT

Color Quality

COLOR QUALITY - 3500K

TM-30 Rr	90
TM-30 Ra	100
CRI	90+
R9	> 50

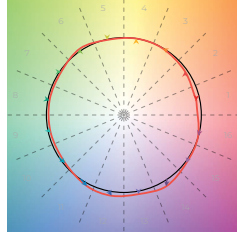

Photometrics

WALL

Values calculated based on 3500K, bevel baffle, and SDL lens option.

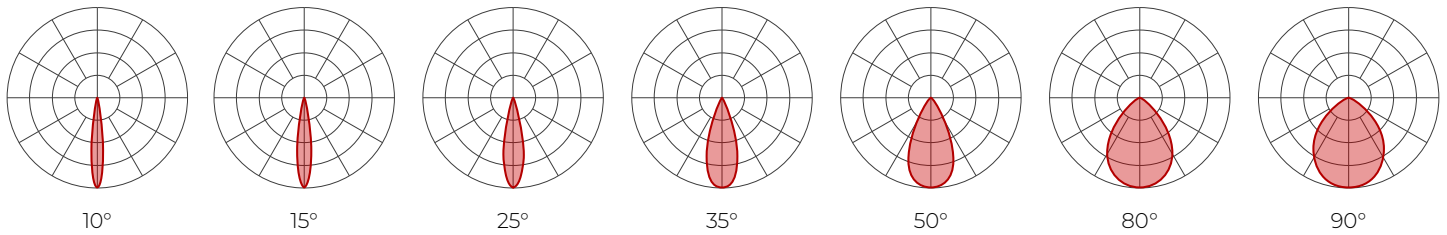

Delivered lumens (LM)

BEAM	80+ CRI							90+ CRI							95+ CRI						
	10°	15°	25°	35°	50°	80°	90°	10°	15°	25°	35°	50°	80°	90°	10°	15°	25°	35°	50°	80°	90°
14 W	1347	1497	1538	1481	1451	1306	1306	1259	1399	1437	1384	1356	1220	1220	969	1077	1106	1066	1044	940	940
20 W	1880	2089	2146	2066	2026	1823	1823	1757	1952	2006	1931	1893	1704	1704	1353	1503	1545	1487	1458	1312	1312
28 W	2524	2804	2882	2775	2719	2447	2447	2359	2621	2693	2593	2541	2287	2287	1816	2018	2074	1997	1957	1761	1761
32 W	2876	3196	3285	3163	3099	2789	2789	2689	2988	3070	2956	2896	2607	2607	2070	2300	2364	2276	2231	2007	2007

Efficacy (LM/W)

BEAM	80+ CRI							90+ CRI							95+ CRI						
	10°	15°	25°	35°	50°	80°	90°	10°	15°	25°	35°	50°	80°	90°	10°	15°	25°	35°	50°	80°	90°
14 W	96	107	110	106	104	93	93	90	100	103	99	97	87	87	69	77	79	76	75	67	67
20 W	94	104	107	103	101	91	91	88	98	100	97	95	85	85	68	75	77	74	73	66	66
28 W	90	100	103	99	97	87	87	84	94	96	93	91	82	82	65	72	74	71	70	63	63
32 W	90	100	103	99	97	87	87	84	93	96	92	90	81	81	65	72	74	71	70	63	63

MULTIPLIERS

Please follow the multiplier tables to ensure correct lumen value. Beams, CCT, baffle styles, baffle colors, lensing and accessories will change the lumen value.

CCT	BAFFLE STYLE AND COLOR			LENS * (At baffle)		ACCESSORIES * (At light element)		
2200K	0.80	Bevel	White	1	SDL - Soft diffused lens, Solite	1	LSDL - Soft diffused lens, Solite	1
2400K	0.87		Black	1				
2700K	0.94	Pinhole	White	0.92	FDL - Frosted lens	0.8	LFDL - Frosted lens	0.8
3000K	0.98		Black	0.92	CL - Clear lens	1.1	LS - Linear spread	0.84
3500K	1				NOL - No lens	1.1	HEX - Hex louver	0.86

* When more than one lens or accessory is specified, multiply together the value of each lens and/or accessory.
e.g. NOL + LSDL + LS = 1.1 x 1 x 0.84 = 0.924

DIRECT/INDIRECT - LPW CALCULATION

For Direct/Indirect performance values, follow the formula.

$$\left(\frac{\text{DIRECT LM} + \text{INDIRECT LM}}{\text{DIRECT W} + \text{INDIRECT W}} \right) = \text{LPW}$$

For SOLA and DUO, please consult factory.



AERA 5" CYLINDER

WALL

DIRECT/INDIRECT, DIRECT, INDIRECT



Technical Specifications

OPTIC

XPoint™ Refraction Technology optics provide precise optical control in a remarkably compact form. Micro optical paths from the chip on board converge and then disperse in precise beam angles, resulting in a crisp and exacting light quality.

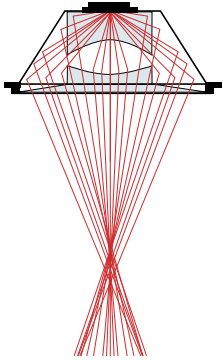

LIGHT SOURCE

Static white

Compact COB (Chip-On-Board) LED module, available in 2200K, 2400K, 2700K, 3000K, 3500K, 4000K, and 5000K with a choice of 80+ CRI, 90+ CRI, or 95+ CRI, with elevated R9 value for 90+ CRI and above. Color consistency is maintained to within 2 SDCM. All LEDs have been tested in accordance with IESNA LM-80-08 and the results have shown L80 lumen maintenance greater than 60,000 hours. Absolute product photometry is measured and presented in accordance with IESNA LM-79, unless otherwise indicated.

Full spectrum static white

The full spectrum LED option offers improved color particularly in the cyan region that is beneficial in both healthcare and circadian lighting strategies. The cyan region in full spectrum LED is richer at the 480 nm range.

Chromawerx SOLA

Chromawerx SOLA is single-channel control that dims output while warming the color temperature in a pre-determined relationship. Two color temperature range options are offered: 3000K to 1800K, and 2700K to 1800K. A simple analog control adjusts a specially populated LED array to emulate the effect of dimming a filament source.

Chromawerx DUO

Chromawerx DUO offers a two-channel control system which uses analog or digital protocols for synchronous control of both cool to warm LED arrays - maintaining a CRI above 90. Two color temperature range options are offered: 6500K to 2700K, and 5000K to 2700K. The range of color DUO offers is useful for entraining circadian rhythms, stimulating alertness, and compensating for jet lag among other applications. The Chromawerx drivers are programmed to limit maximum light output and power usage across all color temperatures. When paired with DALI drivers (DDA/DDA8), color tuning follows a linear dimming curve.

ELECTRICAL

Unless otherwise specified, dimming down to 1%. At maximum driver load: efficiency > 84%, PF > 0.9, THD < 20%. ELV and TRIAC dimming performance (including minimum dimming percentage) subject to dimmer selection.

Integral: 0-10V, ELV, TRIAC

Remote: 0-10V, ELV, TRIAC, Lutron Hi-Lume 1% EcoSystem, DALI, eldoLED 0.1% SOLOdrive 0-10V, eldoLED 1% ECOdrive 0-10V, DMX, Lutron DALI-2 digital

Emergency battery option: Remotely-installed, long-life, high-temperature, maintenance-free, Bodine Lithium-Ion battery pack with self-test functionality, test switch and charge indicator. IOTA and Fulham options available upon request. Minimum of 90 minutes operation, and recharge time of 24 hours. For fixtures less than 10 W, the battery provides 6 W of emergency light output. For fixtures 10 W and over, the battery provides 10 W.

PoE

Depending on the PoE manufacturer selected, Lumenwerx will install the node in factory as either integral to the luminaire or as a remote module. Factory programming of the PoE node may or may not enable the following functionalities: lumen package, DUO (tunable white), QUADRO (RGBW), emergency battery backup, and sensor integration. These must be addressed and evaluated on a case-by-case basis.

CONSTRUCTION

Housing: Extruded aluminum

Canopy: Flat and direct

Arm: Machined aluminum

Finish: Matte white, matte black, champagne, and dark bronze. Custom colors also available (provide RAL #). Satin silver and matte silver finishes are also available for Baffle.

Heat sink: Die-cast aluminum

Baffle: Die-cast aluminum

Baffle style: Bevel and pinhole

AERA 5" CYLINDER

WALL

DIRECT/INDIRECT, DIRECT, INDIRECT



WEIGHT

Direct/Indirect	Direct or Indirect
8" : 4.5 lbs - 2 kg	6" : 3.5 lbs - 1.5 kg
12" : 5 lbs - 2.2 kg	8" : 3.5 lbs - 1.5 kg
14" : 5.5 lbs - 2.5 kg	12" : 4 lbs - 1.8 kg
	14" : 4.5 lbs - 2 kg

LENS AND ACCESSORIES



ENVIRONMENT

Ambient temperature at fixture location shall be within 0°C/32°F - 25°C/77°F, indoor dry or damp as well as outdoor damp use (canopies or marquees).

CERTIFICATIONS

ETL: Rated for indoor dry/damp locations. Conforms to UL Standard 1598 and certified to CAN/CSA Standard C22.2 No. 250.0.

Declare: [LBC Red List Approved](#)

WARRANTY

Lumenwerx provides a five-year limited warranty on electrical and mechanical performance of the luminaires, including the LED boards, drivers, and auxiliary electronics. Lumenwerx will repair or replace defective luminaires or components at our discretion, provided they have been installed and operated in accordance with our specifications. Other limitations apply, please refer to the full warranty on our website.