

ALCOVE LED



LUMENWERX
WWW.LUMENWERX.COM

CHROMAWERX TUNABLE WHITE AND DIM TO WARM

IMPORTANT: a qualified DMX integration consultant is required to ensure proper installation and function of any DMX network

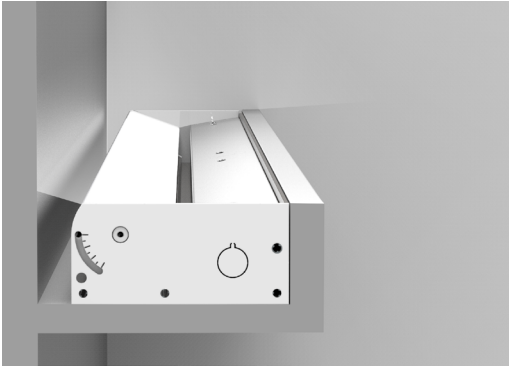

DESCRIPTION

ALCOVE LED is a compact, high-performance luminaire providing efficient asymmetric light distribution. ALCOVE measures just 1 13/16" high by 3 7/8" deep. With peak intensity at 110°, adjustable optics, light output from 350 to 1200 lumens per foot, and efficacy up to 134LPW, ALCOVE delivers very effective ceiling illumination. Highly flexible, ALCOVE installs in site-built coves and other architectural enclosures, either as individual luminaires or in continuous runs with quick-connect wiring. Driver and LED boards are accessible without removing the luminaire. ALCOVE is an ideal vehicle for ChromaWerx white tuning in education, office, and healthcare applications where modular luminaires are used.

PROJECT: _____

TYPE: _____

NOTES: _____

ORDER GUIDE

up to 134 lm/w performance

ALC	APO	LED			
LUMINAIRE ID	OPTICS	LIGHT SOURCE	CRI	INDIRECT LUMEN PACKAGES	CHROMAWERX
ALC - alcove	APO - Adjustable Asymmetric Projecting Optic	LED - high performance LED	80 - 80CRI 90 - 90CRI	350 - min. eco low output 350lm/ft 550 - low output 550lm/ft 750 - medium output 750lm/ft #### - other required lm/ft	DUO - tunable white 2 channel control 27k to 65k SOLA - dim to warm single channel control 22k to 35k

LUMINAIRE LENGTH	VOLTAGE	DRIVER	ELECTRICAL	MOUNTING	FINISH	OPTIONS
Available sections - 4', 8' & 12' #FT - nominal length in feet (2' increments only) Continuous Run - for luminaires over 12' Minimum Individual section 4'	120 - 120V 277 - 277V	DMX - to specify see pages 5 to 10 DA - Dali (duo only) local on-site commissioning is required O-10 - Single 0-10V input (Sola) or dual 0-10V input for CCT/Intensity (Duo) PSQO - Lutron T-Series 1% Tunable White	1-1 circuit	COVH - cove horizontal COVV - cove vertical	W - matte white	FU120 - Fuse 120V FU277 - Fuse 277V CU - custom

See page 2 for ordering code detailed information

DMX WALL CONTROLS

To specify see pages 5 to 10

CROSS SECTION

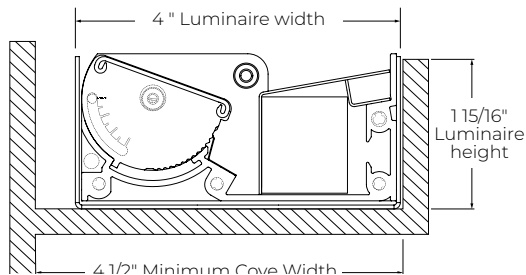

ALC - alcove

OPTICS



APO - Asymmetric Projecting Optics



ANSI C78.377-2015

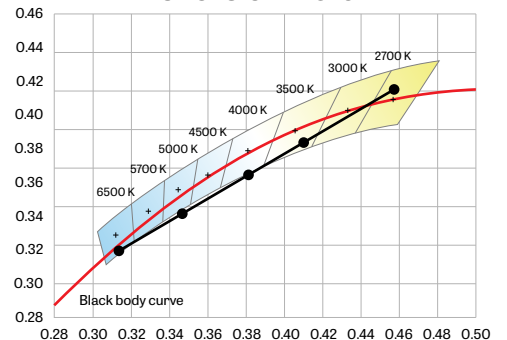

ALCOVE LED

CHROMAWERX TUNABLE WHITE AND DIM TO WARM

OPTICS

ASYMMETRIC PROJECTING OPTIC (APO) -

Cartridge-mounted, linear LED arrays are paired with precisely formed specular and matte white reflectors for smooth light distribution. The LED array is protected by a clear acrylic cover. For maximum horizontal projection, the APO cartridge is angled 20°. This produces peak intensity at 110° above nadir and a peak-to-zenith intensity ratio of 11.8:1. Field angle coverage extends for 80°. For optimal beam spread, locate ALCOVE at least 8" below the ceiling.

Field Adjustable Aiming (13 options)

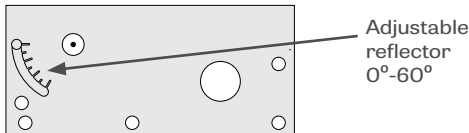

The Asymmetric Projecting Optic cartridges can be rotated upwards on site by 60° to increase vertical projection. Click-stop of 5° intervals, as well as visible aiming marks, provide 13 discrete aiming angles and simplify consistent orientation in long coves.

Horizontal Mount

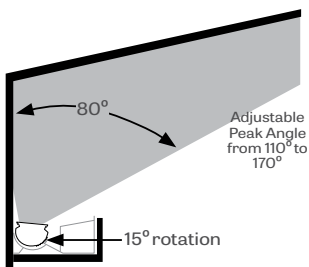
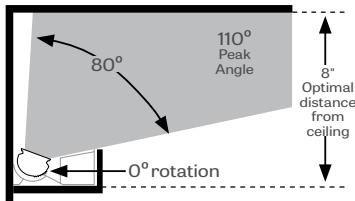

Vertical Mount

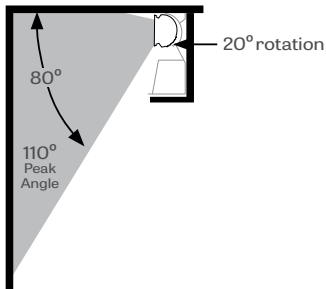

LIGHT SOURCE - LED

PERFORMANCE PER 4' AT 4000K

LED OUTPUT	COLOR TEMP	WATTS	NOMINAL DELIVERED LUMENS	EFFICACY LPW
eco low output	4000K	10.5	1400	131
low output	4000K	16.5	2200	134
medium output	4000K	23.5	3000	129
high output	4000K	30	3800	127
ultra high output	4000K	38	4800	127

Lumen Adjustment Factors

2700K	0.917
3000K	0.959
3500K	0.988
4000K	1.000
6500K	1.053

Custom linear array of alternating color temperature mid-flux LED's are mounted directly to the housing for optimal thermal performance. For the Duo products, a color temperature range from 2700K-6500K is achievable with color points on or below the black body curve. For the Sola products, a color temperature range from 2200K-3500K is controlled synchronously with intensity. Color consistency between fixtures is maintained to within 3SDCM. LEDs are operated at reduced drive current to optimize efficacy and lumen maintenance.

All LED's have been tested in accordance with IESNA LM-80-08 and the results have shown L80 lumen maintenance greater than 60,000 hours. Absolute product photometry is measured and presented in accordance with IESNA LM-79, unless otherwise indicated.

LUMINAIRE LENGTH

ALCOVE is highly flexible and can be installed as a single luminaire up to 12' long (see ordering code) or in continuous runs with a maximum module length of 8' (to simplify aiming). In continuous runs, modules are connected with easy-to-install joiner kits and electrical quick-connects. Total luminaire length must be 2" shorter than the inside of the cove to permit access to electrical connections.

CHROMAWERX TUNABLE WHITE AND DIM TO WARM

CHROMAWERX - TUNABLE WHITE

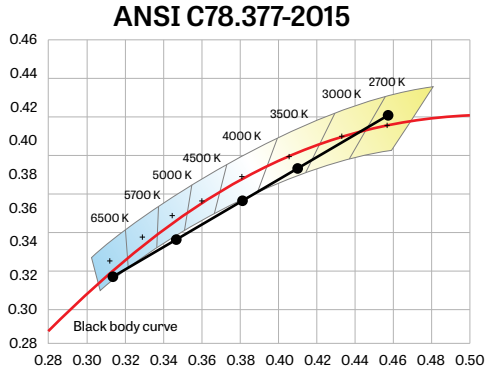

ChromaWerx Sola is single-channel control that dims output while warming the color temperature in a pre-determined relationship. A simple digital or analog control sends a common signal to dual output digital drivers, which are programmed to adjust a specially populated LED array to emulate the effect of dimming a filament source. Dimming range is programmable but the default option runs from 3500K at 100% of full power to 2200K at 5% of full power. CRI is maintained above 80 throughout the dimming range.

ChromaWerx Duo is two-channel control. It uses an analog (0-10V) protocol for separate control of luminaire CCT and intensity or a digital (DMX, DALI) protocol for synchronous control of both warm and cool LED arrays to enable the user to set color temperature and light output. Commonly called "tunable white", ChromaWerx two-channel control provides the range of warm (2700K) to cool (6500K) color that can be useful for helping to entrain circadian rhythms, stimulate alertness for improved educational and work productivity, and compensate for jet lag, among other applications. The ChromaWerx drivers are programmed to limit maximum light output and power usage across all color temperatures. CRI is maintained above 80.

ELECTRICAL

DMX (Duo only)

Factory-set, adjustable output current, multi-channel LED driver with universal (120-277VAC) input. Using DMX wall controls (optionally supplied by LumenWerx) or an existing DMX control system, either two channels of LEDs (warm-white & cool-white) for DUO or four channels of LEDs (Red/Green/Blue/White) for QUADRO are independently adjustable. Each DMX driver has multiple output channels that can be independently addressed at the factory or on-site using built-in RDM (Remote Device Management) functionality. Dimming range from 100%-0%. At maximum driver load, efficiency < 89%, PF > 0.9, THD < 20%.

Dali (Duo Only)

Factory-set, adjustable output current LED driver with universal (120-277VAC) input. Using an existing DALI control system (supplied by others), one control channel adjusts the fixture color temperature, and the other control channel adjusts fixture brightness. Dimming range from 100%-0%. At maximum driver load, efficiency < 86%, PF > 0.9, THD < 20%.

0-10V (Sola)

Factory-set, adjustable output current LED driver with universal (120-277VAC) input. Using a single 0-10V control signal, the light output warms in color temperature as it dims down to 1% and 2200K. At maximum driver load, efficiency < 86%, PF > 0.9, THD < 20%.

0-10V (Duo)

Factory-set adjustable output current LED driver with universal (120-277VAC) input. Controlled via two individual 0-10V signals, one for setting light output down to a minimum of 1% and the other for adjusting the CCT (default range of 2700K-6500K). Rated life of 50,000 hours at 70°C maximum driver case temperature and 100% load conditions. Typical efficiency of 86%, PF > 0.9, THD < 20% at 100% load conditions.

ADJUSTABLE MOUNTING BRACKET

For optimal performance, ALCOVE should be installed flush to the top of the cove and is furnished with an adjustable mounting bracket to help locate the luminaire in coves of different depths. Mounted directly to the bottom of the cove, ALCOVE will be properly positioned in a cove with an inside depth of 1 15/16". The mounting bracket help raises the luminaire up to 3 5/16" in 1/8" increments. Other brackets height can be specified.

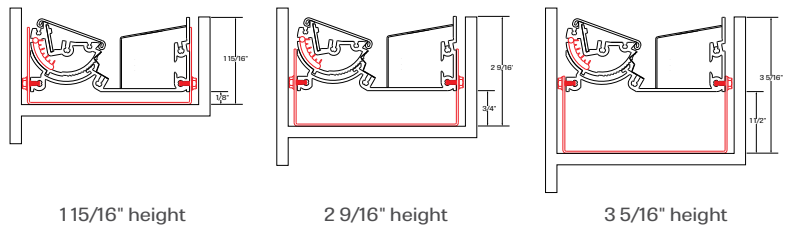

1 15/16" height

2 9/16" height

3 5/16" height

ALCOVE LED

CHROMAWERX TUNABLE WHITE AND DIM TO WARM

FINISH

Interior - 95%, reflective matte powder coated white paint

Exterior - matte white powder coating.

CONSTRUCTION

Housing - extruded aluminum 0.075" nominal thickness / Painted White

Reflectors - extruded aluminum 0.080" nominal thickness / Unfinished

Dust-Cover - Extruded Clear Acrylic 0.050" nominal thickness

Interior Brackets - 22 GA CRS / Painted White

White Reflectors - 22 GA CRS / Painted White

Specular reflectors - Specular aluminum sheet 0.020" thickness / Unfinished

End-Plates - 16 GA CRS / Painted White

Reflector Cartridge End-Plates - 14 GA CRS / Painted White

Joiner Plates - 16 GA CRS / Painted White

MAINTENANCE

LED boards are removable from the cartridge for easy replacement. Both cartridge and driver are accessible without removing the luminaire.

WEIGHT

ALCOVE 4ft - 4.2Kg - 9.4 lb

ALCOVE 8ft - 8.4Kg - 18.8 lb

ALCOVE 12ft - 12.6Kg - 28.2 lb

CERTIFICATIONS

ETL - Rated for Indoor Dry/Damp locations.

Conforms to UL Standard 1598 and certified to CAN/CSA Standard C22.2 No. 250.0.

WARRANTY

For all ChromaWerx products, LumenWerx provides a three-year limited warranty of electrical and mechanical performance of the luminaires, including the LED boards, drivers, and auxiliary electronics.

LumenWerx will repair or replace defective luminaires or components at our discretion, provided they have been installed and operated in accordance with our specifications. Other limitations apply, please refer to the full warranty on our website.

Wall controllers are covered by the manufacturer warranty.

ALCOVE LED

CHROMAWERX TUNABLE WHITE

DUO DMX SPECIFICATION

A qualified DMX integrator is required to assure proper installation and commissioning of the DMX network. **When placing the PO, please provide the contact information of your DMX integrator.**

Please answer the following questions to help us identify your DMX network requirements.

YES

Do you require a wall controller provided by Lumenwerx?

NO

DMX control system supplied by others. Lumenwerx will supply DMX-enabled fixtures with default DMX addressing. See following pages for technical DMX informations. ✓

DMX controller supplied by Lumenwerx

How many zones do you have?

A zone consists of one or more luminaires behaving identically.

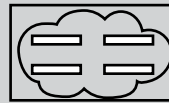

1 Zone



2 Zones

How to calculate the required number of drivers:

per 4' fixture

Driver

1x driver

Direct only

per 4' fixture

Driver Driver

2x driver

Direct high output

To Calculate # of drivers

1 - 4 Zones

5 or more Zones

Do you have more than 32 drivers in total?

NO

YES

Order a standard Lumenwerx wall controller.

WALL CONTROLLER

WCW - wall controller white
WCB - wall controller black

Add the control code at the end of your order code.

Please provide a fixture layout or RCP (Reflected Ceiling Plan) showing the locations of the DMX fixtures, zones and the DMX wall controller.

Refer to your DMX integrator for the installation. ✓

Subject to factory evaluation. Please contact our controls specialist at controls@lumenwerx.com. Additional cost and equipment will be required. ✓

Subject to factory evaluation and approval. Please contact our controls specialist at controls@lumenwerx.com. Additional cost and equipment will be required. ✓

ALCOVE LED

CHROMAWERX TUNABLE WHITE

GENERIC DMX NETWORK ARCHITECTURE

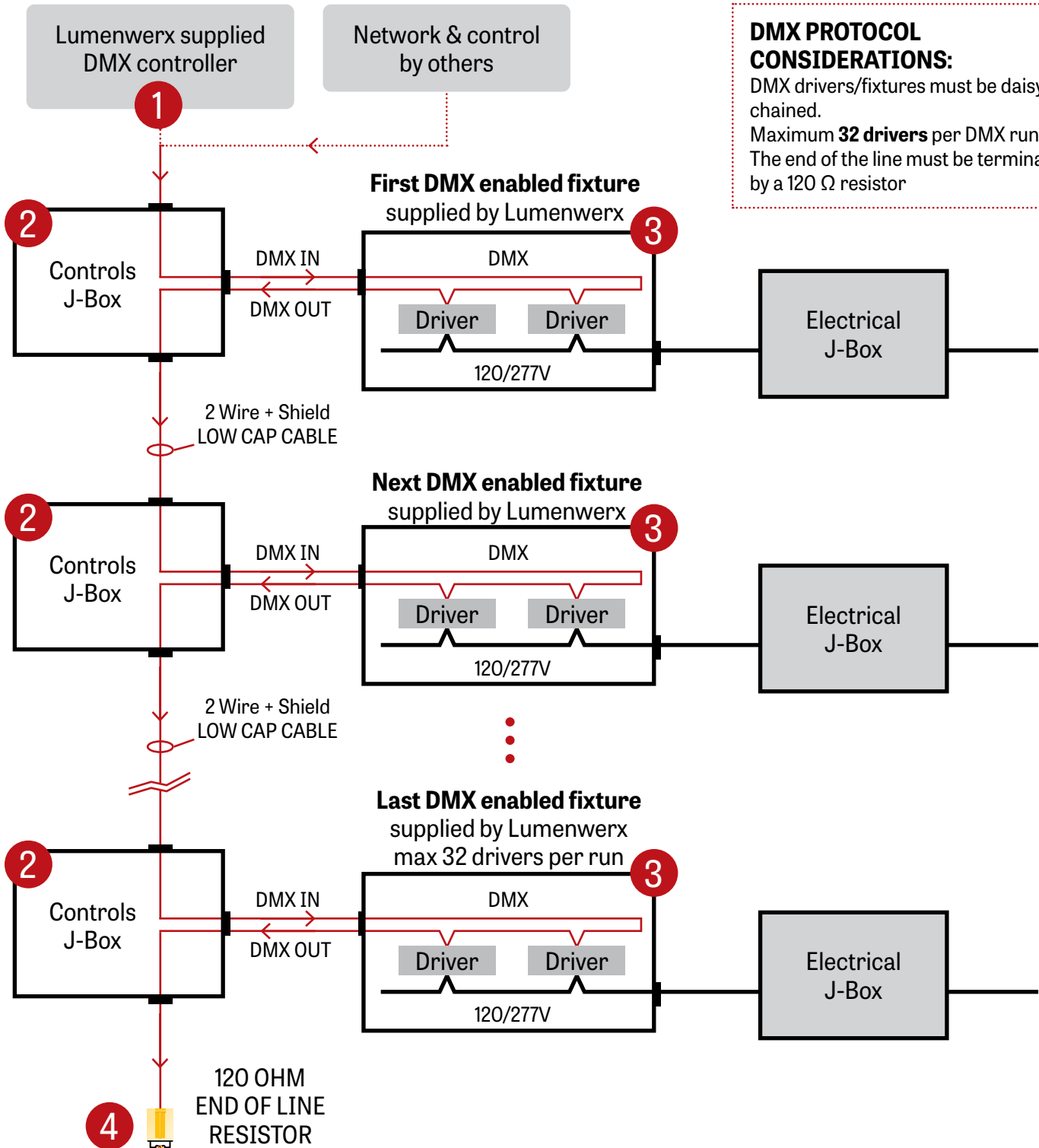

ALCOVE LED

CHROMAWERX TUNABLE WHITE

1 LUMENWERX SUPPLIED DMX CONTROLLER

To the first fixture

WALL BOX SUPPLIED BY OTHERS

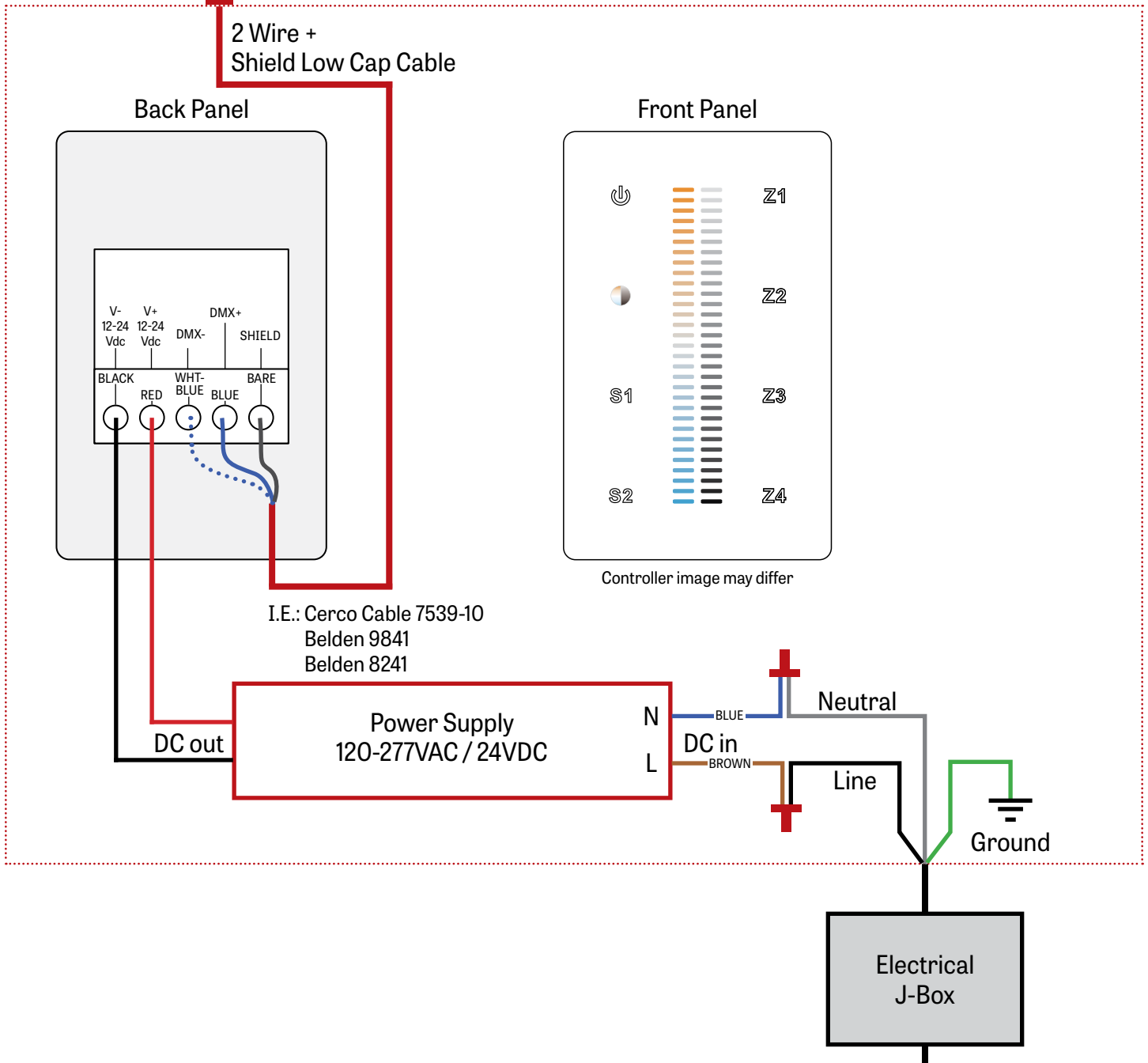

ALCOVE LED

CHROMAWERX TUNABLE WHITE

2 J-BOX DMX DAISY CHAIN DETAIL

Low capacitance DMX Cable from Previous Fixture

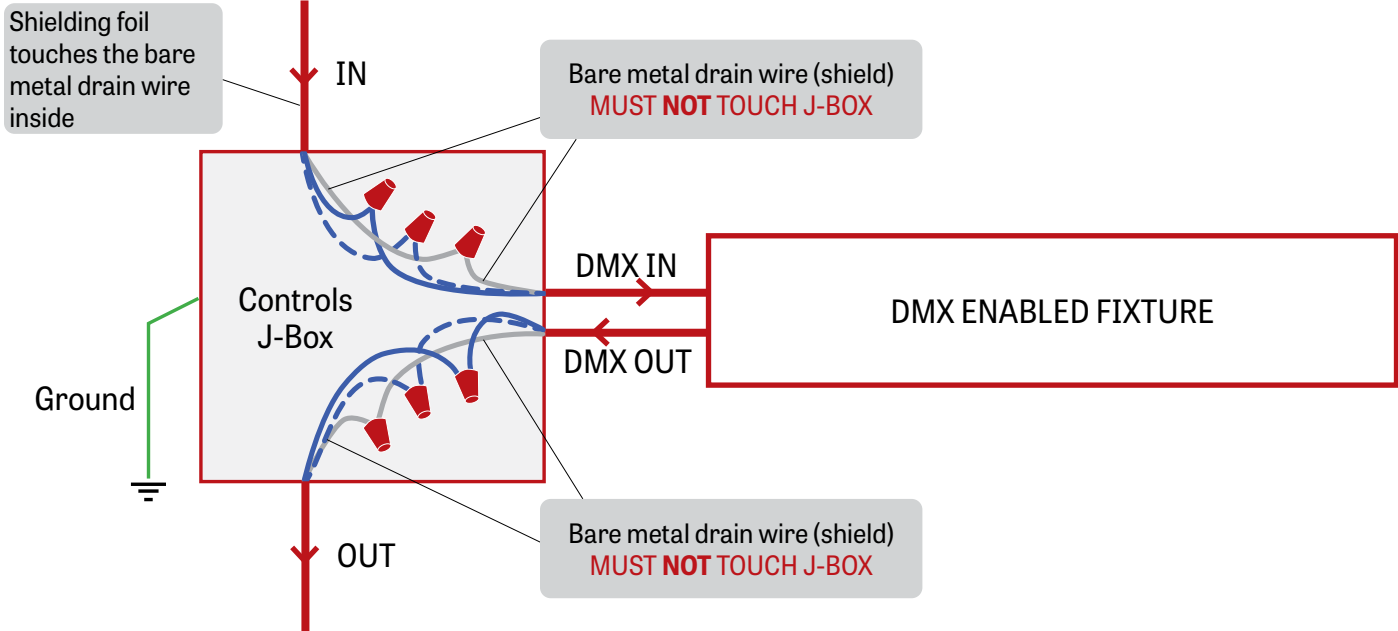

Low capacitance DMX cable to next fixture

3 DMX CONNECTION RECESSED & SURFACE

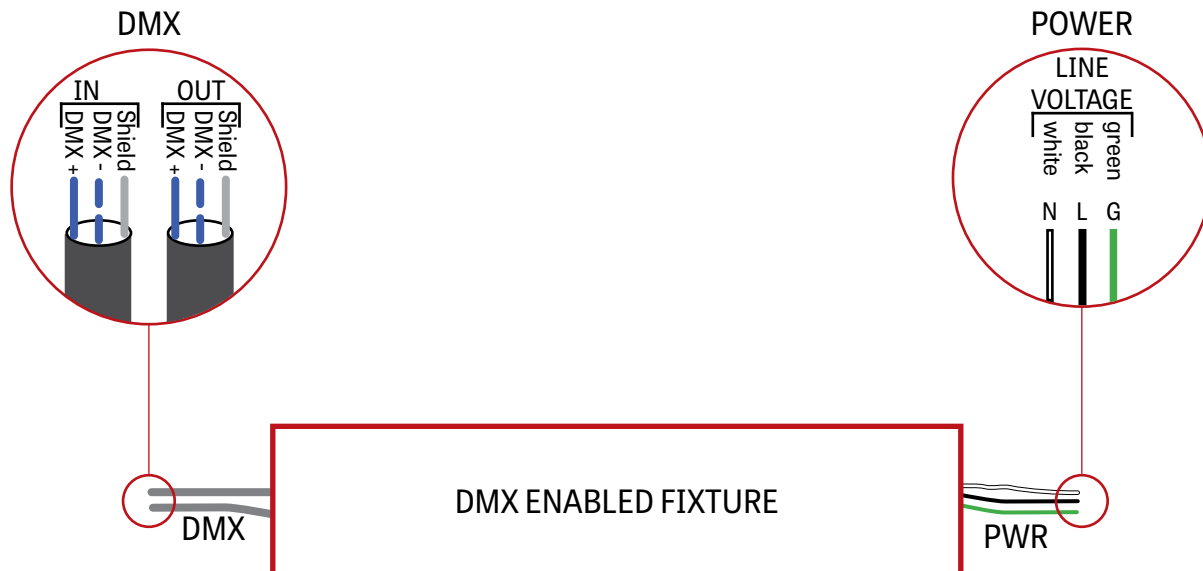

4 DMX LAST FIXTURE DETAIL

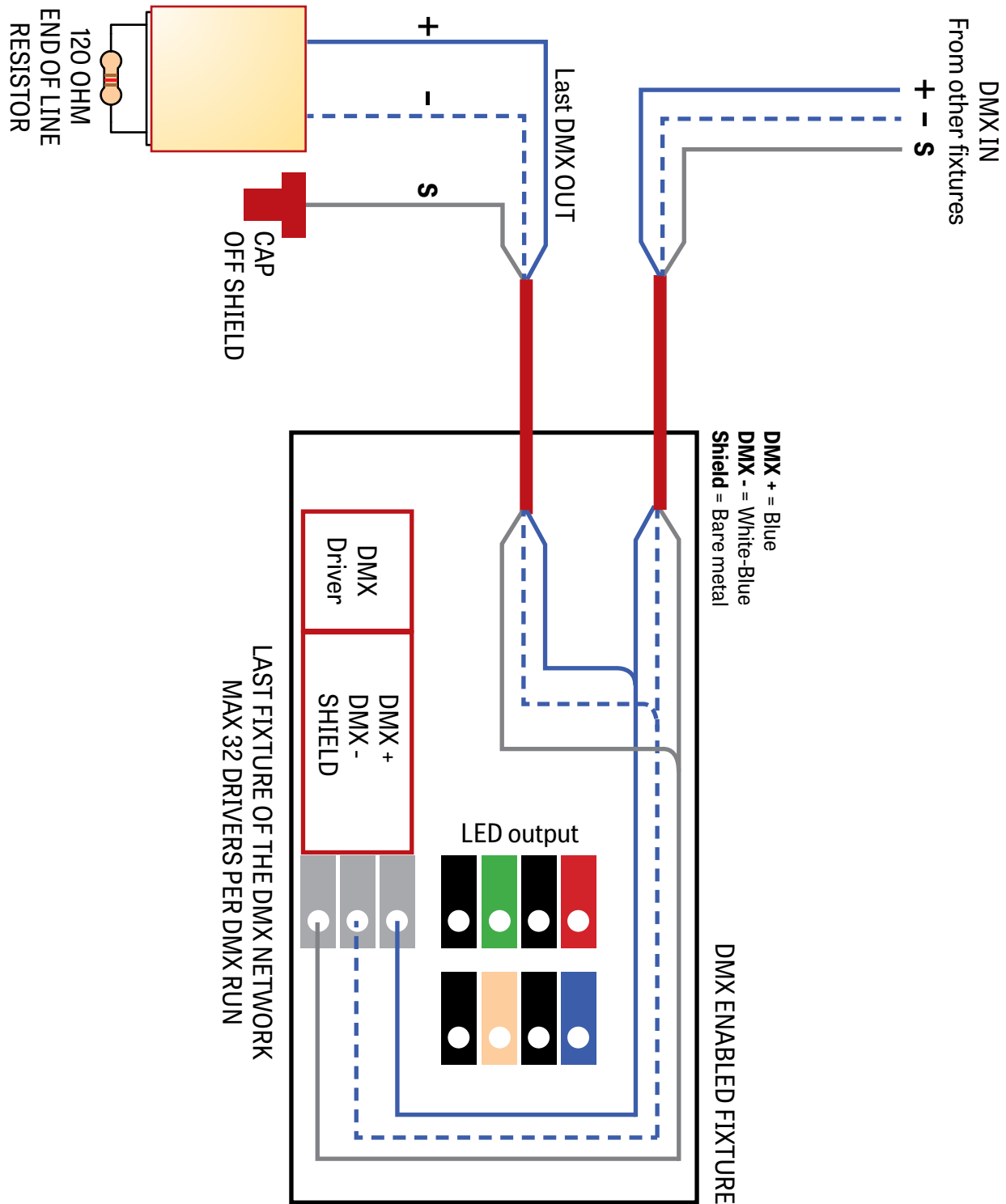

ALCOVE LED

CHROMAWERX TUNABLE WHITE

DMX WALL CONTROLLER

DUO 1-4 ZONE

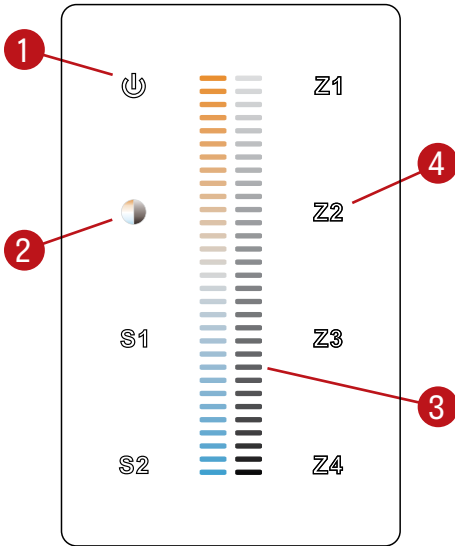

- (1) Power: Use this button to turn ON or OFF the fixture.
- (2) Brightness/CCT: Use the color/brightness toggle button to choose between color/brightness. When Blue: brightness is selected, when Yellow: color is selected.
- (3) Slider: Depending on the mode chosen in step 2, the slider will allow the user to set desired color or brightness.
- (4) Zone select: Up to 4 zones can be selected either independently or together. Once selected, the commands will be sent to the zone identified by a Blue LED.

Default DMX Addresses:

- 1 Warm
- 2 Cool

ALCOVE LED

CHROMAWERX TUNABLE WHITE AND DIM TO WARM

350 LUMEN AT 80CRI - ECO LOW OUTPUT

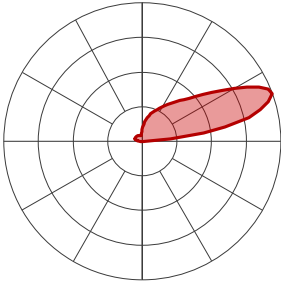

PERFORMANCE PER 4'

LED output	Color Temp	Watts	Nominal Delivered Lumens	Efficacy LPW
eco low output	2700K	11.5	1400	121
eco low output	3000K	11	1400	125
eco low output	3500K	11	1400	127
eco low output	4000K	10.5	1400	131
eco low output	6500K	10.5	1400	136

550 LUMEN AT 80CRI - LOW OUTPUT

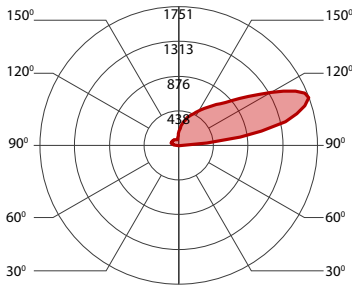

PERFORMANCE PER 4'

LED output	Color Temp	Watts	Nominal Delivered Lumens	Efficacy LPW
low output	2700K	18	2200	123
low output	3000K	17.5	2200	127
low output	3500K	17	2200	129
low output	4000K	16.5	2200	134
low output	6500K	16	2200	139

750 LUMEN AT 80CRI - MEDIUM OUTPUT

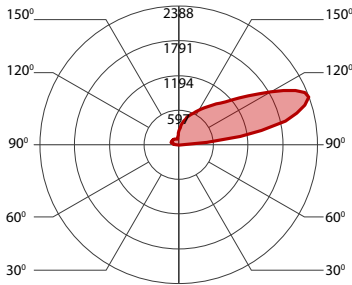

PERFORMANCE PER 4'

LED output	Color Temp	Watts	Nominal Delivered Lumens	Efficacy LPW
medium output	2700K	25	3000	119
medium output	3000K	24.5	3000	122
medium output	3500K	24	3000	125
medium output	4000K	23.5	3000	129
medium output	6500K	22.5	3000	134