

# AUDIA

ACOUSTIX - CHROMAWERX  
SOLA AND DUO



Project: \_\_\_\_\_

Type: \_\_\_\_\_

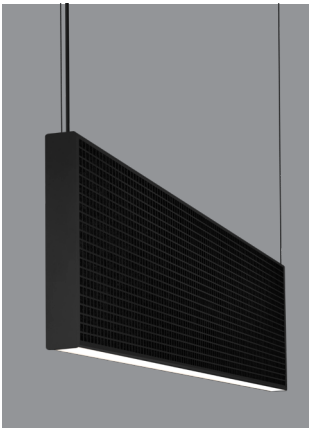

Full perforation

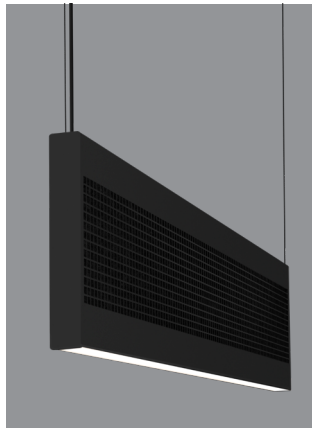

Half perforation

### Section View

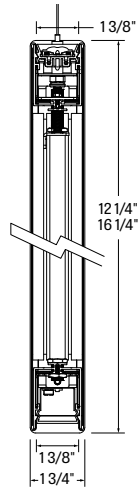

Direct/Indirect

Our premium acoustic offering Audia use the science of Helmholtz resonance to trap acoustic waves through aluminum lattice, wrapped around proprietary sound absorbing material. With its slim core, narrow body and multiple color options, Audia was designed from the ground up with sound and light engineering in mind. Using our patent pending EchoCore™ technology we have constructed layers of sound absorbing material coupled with precise air pockets into a patterned aluminum body with a curved soft regress light reveal without compromising luminaire performance in our HLO (High Lambertian Optics) optics that delivers excellent efficacy. Audia is available in Chromawerx SOLA and DUO. Static White, Biologically Optimized White and Chromawerx QUADRO are also available, see separate spec sheets.

## Order Guide

LUMINAIRE ID	DISTRIBUTION	DIRECT OPTIC Specify NA for Indirect fixture	INDIRECT OPTIC Specify NA for Direct fixture	LIGHT SOURCE	CRI	DIRECT LUMEN PACKAGE Specify NA for Indirect fixture
<b>AUDFACOP</b> - Audia Full Perforation Pendant <b>AUDHACOP</b> - Audia Half Perforation Pendant	<b>DI</b> - Direct/Indirect <b>D</b> - Direct <b>I</b> - Indirect	<b>HLO</b> - High-efficiency Lambertian optic <b>NA</b> - Not applicable	<b>WIO2</b> - Widespread indirect optics <b>NA</b> - Not applicable	<b>DUO</b> - Tunable white 2-channel control 27K to 65K <b>SOLA</b> - Dim-to-warm single channel control 22K to 35K	<b>80</b> - 80CRI <b>90</b> - 90CRI	<b>350</b> - Min. low output 350lm/ft <b>500</b> - Medium output 500lm/ft <b>NA</b> - Not applicable

INDIRECT LUMEN PACKAGE Specify NA for Direct fixture	LUMINAIRE LENGTH	LUMINAIRE HEIGHT	VOLTAGE	DRIVER	ELECTRICAL
<b>350</b> - Min. low output 350lm/ft <b>500</b> - Medium output 500lm/ft <b>NA</b> - Not applicable	<b>Standard individual sections (nominal length):</b> 4', 8', 12' <b>Continuous runs:</b> lengths over 12'  <b>#FT</b> <sup>1</sup> - specify nominal length (#) in 4 foot increments  <sup>1</sup> Consult factory for other lengths.	<b>12</b> - 12 inches <b>16</b> - 16 inches	<b>120</b> -120V <b>277</b> - 277V <b>UNV</b> - 120V-277V	<b>SOLA</b> <b>SDI</b> - Single 0-10V input  <b>DUO</b> <b>DMX</b> <sup>2,3</sup> - DMX <b>DA</b> <sup>2</sup> - DALI <b>DD1</b> - Dual 0-10V input for CCT/intensity <b>LD2</b> <sup>2</sup> - Lutron DALI-2 digital  <sup>2</sup> On-site commissioning is required. <sup>3</sup> To specify, see pages 8 to 13.	<b>1</b> - 1 circuit <b>2</b> <sup>4</sup> - 2 circuits <b>+EM</b> <sup>4,5</sup> - Emergency light circuit <b>+NL</b> - Night light circuit  <sup>4</sup> 2+EM/NL only available for 8' or longer. <sup>5</sup> Available with 0-10V drivers only.

MOUNTING	FIXTURE FINISH	PERFORATION OPTION	FIXTURE INTERIOR COLOR	OPTIONS	DMX WALL CONTROLS (OPTIONAL) <sup>9</sup>																															
<b>53WAC36W</b> <sup>6</sup> - 36" aircraft cable, white canopies (5" power + 3" non-power), white power cord <b>53WAC36B</b> <sup>6</sup> - 36" aircraft cable, white canopies (5" power + 3" non-power), black power cord <b>55WSW18</b> - 18" white stem, white canopies (5" power + 5" non power)  <sup>6</sup> Power cord is 6" longer than suspension length. Consult factory for other lengths.	<b>AL</b> - Aluminum <b>B</b> - Matte black <b>W</b> - Matte white  <b>CF#</b> - Custom finish, specify RAL#	<b>SQ</b> - Square <b>RD</b> - Round <b>CP#</b> - Custom perforation	<b>STANDARD COLORS</b> <table border="0"> <tr> <td> FWN</td> <td> LVN</td> </tr> <tr> <td> FON</td> <td> LEN</td> </tr> <tr> <td> ION</td> <td> CYN</td> </tr> <tr> <td> TBN</td> <td> PMN</td> </tr> <tr> <td> MDN</td> <td> FGN</td> </tr> </table>	FWN	LVN	FON	LEN	ION	CYN	TBN	PMN	MDN	FGN	<b>PREMIUM COLORS</b> <sup>7,8</sup> <table border="0"> <tr> <td> PKN</td> <td> CDN</td> <td> IVN</td> <td> BHN</td> </tr> <tr> <td> OGN</td> <td> LCN</td> <td> SLN</td> <td> CFN</td> </tr> <tr> <td> LNN</td> <td> SYN</td> <td> CNN</td> <td> GRN</td> </tr> <tr> <td> LMN</td> <td> BLN</td> <td> GHN</td> <td> MON</td> </tr> <tr> <td> EGN</td> <td> NVN</td> <td> CLN</td> <td> ESN</td> </tr> </table> <sup>7</sup> Please consult factory for more color options. <sup>8</sup> Lead time may vary.	PKN	CDN	IVN	BHN	OGN	LCN	SLN	CFN	LNN	SYN	CNN	GRN	LMN	BLN	GHN	MON	EGN	NVN	CLN	ESN	<b>FU120</b> - Fuse 120V <b>FU277</b> - Fuse 277V <b>TB#</b> - T-bar caddy clip, specify grid size <b>TC#</b> - Tegular caddy clip, specify grid size <b>ST</b> - Screw slots caddy clip <b>CU</b> - Custom	<b>WCW</b> - Wall controller white <b>WCB</b> - Wall controller black  <sup>9</sup> For more information, see pages 8 to 13, or consult factory.
FWN	LVN																																			
FON	LEN																																			
ION	CYN																																			
TBN	PMN																																			
MDN	FGN																																			
PKN	CDN	IVN	BHN																																	
OGN	LCN	SLN	CFN																																	
LNN	SYN	CNN	GRN																																	
LMN	BLN	GHN	MON																																	
EGN	NVN	CLN	ESN																																	

# AUDIA

ACOUSTIX - CHROMAWERX  
SOLA AND DUO



# Lumenwerx

## Standard Color Options



**FWN** - FROST WHITE

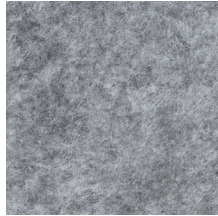

**FON** - FOG

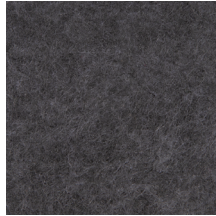

**ION** - IRON

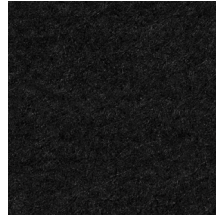

**TBN** - TRUE BLACK



**MDN** - MIDNIGHT BLUE



**LVN** - LAVENDER



**LEN** - LATTE



**CYN** - CHERRY



**PMN** - PLUM



**FGN** - FOREST GREEN

## Premium Color Options\*



**PKN** - PAPRIKA



**OGN** - ORANGE



**LNN** - LEMON



**LMN** - LIME

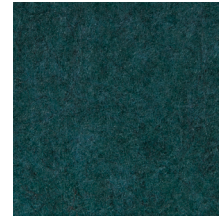

**EGN** - EVERGREEN



**CDN** - CLOUDY



**LCN** - LICHEN

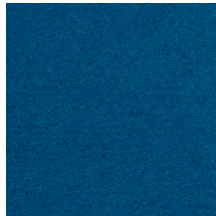

**SYN** - SKY



**BLN** - BLUEBERRY



**NVN** - NAVY

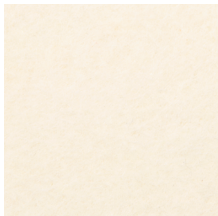

**IVN** - IVORY



**SLN** - STEEL



**CNN** - CARBON

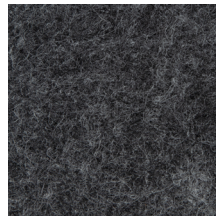

**GHN** - GRAPHITE

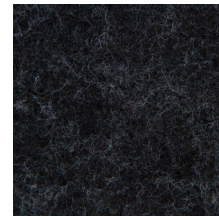

**CLN** - CHARCOAL



**BHN** - BLUSH



**CFN** - CAFÉ



**GRN** - GREIGE



**MON** - MOCHA



**ESN** - ESPRESSO

\*Please consult factory  
for more color options.  
\*Lead time may vary.



## DIMENSIONS

### Section Views

Direct/Indirect

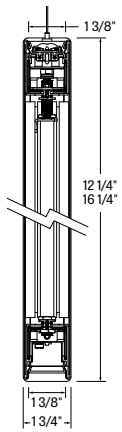

Direct

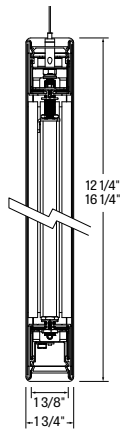

Indirect

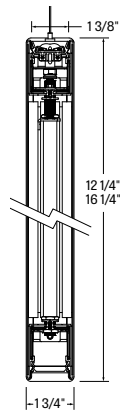

### Front Views

4'

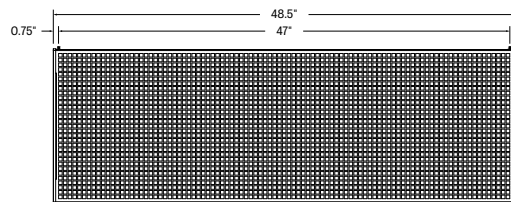

8'

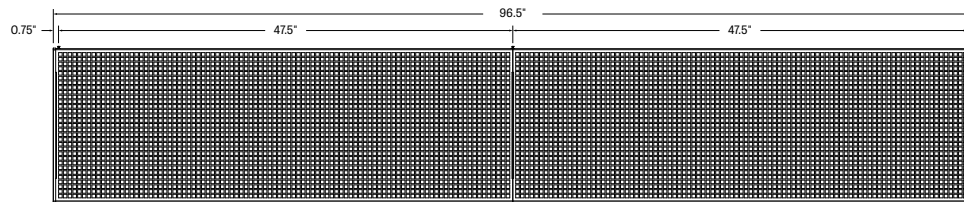

12'

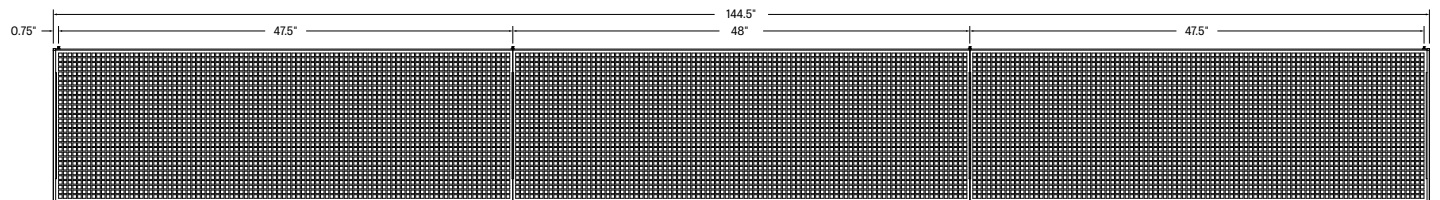



## ACOUSTIC CALCULATOR

Using the Lumenwerx Acoustix Value Calculator table, you can determine the number of acoustic luminaires required in a space by fixture type. We have three levels of recommended sound reduction: good, better, and best. Choosing one of these options will reduce the sound accordingly. The best option indicates the best acoustic improvement. Calculations are based on a standard ceiling height of 9 feet.



- ① Calculate the square feet of your room (L x W).
- ② Choose the level of acoustical improvement you are looking for, and find the corresponding value based on your room dimension and luminaire configuration.

% in reduction in reverberation time		
😊	GOOD	25%
😊😊	BETTER	40%
😊😊😊	BEST	50%

LENGTH	HEIGHT	Room dimensions under 300 sq ft			Room dimensions over 300 sq ft		
		GOOD 😊	BETTER 😊😊	BEST 😊😊😊	GOOD 😊	BETTER 😊😊	BEST 😊😊😊
4 Feet	12"	38	19	12	60	29	19
	16"	51	25	17	84	39	26
8 Feet	12"	76	38	24	120	58	38
	16"	102	50	34	168	78	52
12 Feet	12"	114	57	36	180	87	57
	16"	153	75	51	252	117	78

- ③ Use the Lumenwerx Acoustix Value Formula to determine the number of luminaires needed in the room.

$$\text{Square feet} \div \text{Value} = \text{Number of luminaires}$$

Example:

**Luminaires:** Audia, 4 ft long, 16" high  
**Room square feet:** L: 20 ft x W: 18 ft = 360 sq ft  
**Desired acoustical improvement:** Better = 39  
**Number of luminaires needed in the room:**  $360 \div 39 = 10$  luminaires

NOTES:

- You can mix lit and blank fixtures.
- Lumenwerx acoustic calculators were developed to act as a guide. For precise acoustic performance in a space, please consult an acoustician.



## Technical Specifications

### LUMINAIRE LENGTH:

Audia is made up of standard 4, 8, and 12 foot individual sections that may be joined together to create longer continuous run lengths. Exact run length must be noted in the product code. The minimum individual section available is 4 feet, and continuous run lengths can be ordered in 4 foot increments.

All individual sections are joined together onsite using the joiner kits provided. Lumenwerx joiner kits are extremely simple to work with in the field and result in a fixture that appears virtually seamless with no light leak at any connection.

### CHROMAWERX - TUNABLE WHITE:

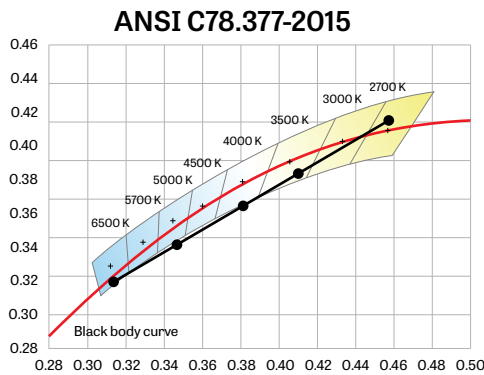

### Chromawerx SOLA

It is a single-channel control that dims output while warming the color temperature in a pre-determined relationship. A simple analog control sends a common signal to dual output digital drivers, which are programmed to adjust a specially populated LED array to emulate the effect of dimming a filament source. Dimming range is programmable but the default option runs from 3500K at 100% of full power to 2200K at 5% of full power. CRI is maintained above 80 throughout the dimming range.

### Chromawerx DUO

It is a two-channel control. It uses an analog (0-10V) protocol for separate control of luminaire CCT and intensity or a digital (DMX, DALI and PSQ0) protocol for synchronous control of both warm and cool LED arrays to enable the user to set color temperature and light output. Commonly called "tunable white", Chromawerx two-channel control provides the range of warm (2700K) to cool (6500K) color that can be useful for helping to entrain circadian rhythms, stimulate alertness for improved educational and work productivity, and compensate for jet lag, among other applications. The Chromawerx drivers are programmed to limit maximum light output and power usage across all color temperatures. CRI is maintained above 80.

### ELECTRICAL:

#### DMX (DUO only)

Factory-set adjustable output current electronic driver with 120-277V AC line input. Using DMX wall controls (optionally supplied by Lumenwerx) or an existing DMX control system, both channels of LEDs are independently adjustable. Each DMX driver can be independently addressed using the built-in RDM (Remote Device Management) in the field. Dimming down to 1% is attainable. Rated life (90% survivorship) of 50,000 hours at 50°C maximum ambient temperature. At maximum driver load, efficiency <84%, PF >0.9, THD <20%.

#### DALI (DUO only)

Factory-set adjustable output current electronic driver with 120-277V AC line input. Using an existing DALI control system (supplied by others), one control channel adjusts the fixture color temperature, and the other control channel adjusts fixture brightness. Dimming down to 1% is attainable. Rated life (90% survivorship) of 50,000 hours at 50°C maximum ambient temperature. At maximum driver load, efficiency <84%, PF >0.9, THD <20%.

#### SDI (SOLA)

Factory-set, adjustable output current LED driver with universal (120-277VAC) input. Using a single 0-10V control signal, the light output warms in color temperature as it dims down to 1% and 2200K. At maximum driver load, efficiency <86%, PF >0.9, THD <20%.

#### DD1 (DUO)

Factory-set adjustable output current LED driver with universal (120-277VAC) input. Controlled via two individual 0-10V signals, one for setting light output down to a minimum of 1% and the other for adjusting the CCT (default range of 2700K-6500K). Rated life of 50,000 hours at 70°C maximum driver case temperature and 100% load conditions. Typical efficiency of 86%, PF >0.9, THD <20% at 100% load conditions.

#### LD2 (DUO only)

Lutron DALI-2 digital drivers provide a high-performance tunable white solution with single-address digital control. Guaranteed performance and compatibility when used with Lutron DALI-2 controls.



## Technical Specifications

### OPTICS:

**High-Efficiency Lambertian Optic (HLO)** - shielding of diffusing 0.075" thick acrylic with up to 88% transmission and good source obscuration. Luminaire brightness is controlled by the flux-to-shielding area ratio.

**Widespread Indirect Optic (WIO2)** - Vertically oriented LED arrays couple light into a linear light guide. A specially designed TIR/microstructure extracts light into the desired "batwing" distribution with smooth ceiling brightness and wide spacing.

### LIGHT SOURCE - LED:

Custom linear array of alternating color temperature mid-flux LEDs are mounted directly to the housing for optimal thermal performance. For the DUO products, a color temperature range from 2700K-6500K is achievable with color points on or below the black body curve. For the SOLA products, a color temperature range from 2200K-3500K is controlled synchronously with intensity. Color consistency between fixtures is maintained to within 3 SDCM. LEDs are operated at reduced drive current to optimize efficacy and lumen maintenance. All LEDs have been tested in accordance with IESNA LM-80-08 and the results have shown L80 lumen maintenance greater than 60,000 hours. Absolute product photometry is measured and presented in accordance with IESNA LM-79, unless otherwise indicated.

### MOUNTING OPTIONS:

**For cable-mounted fixtures** - 53WAC36 (5" white canopy for all power mounting point, 3" white canopy for non power mounting point, and a 36" cable)

**For stem mounted fixtures** - 55WSW18 (5" white canopy for all power mounting point, and non power mounting point, and a 18" white stem)

Caddy clips, if required specify under OPTIONS

### WEIGHT:

**Direct** - Audia 4ft: 16.16lbs - 7.3kg

**Direct/Indirect** - Audia 4ft : 17.86lbs - 8.10kg

**Indirect** - Audia 4ft: 16.16lbs - 7.3kg

### CONSTRUCTION:

**Housing** - Extruded aluminum (0.095" nominal) up to 90% recycled content

**Interior brackets** - Die formed cold rolled sheet steel 18 gauge thick

**Joining system** - Die cast zinc (0.95" nominal)

**Reflectors** - Cold rolled steel 0.024" thick precisely die formed, 95% reflective matte white painted

**Diffuser** - 0.075" thick acrylic, 88% transmission

**Perforated panel** - Die cut aluminum panel ( 18 gauge aluminum sheet)

**End caps** - Die cast aluminum (0.95" nominal)

**Hanger** - Chromed Griplock securely attached with spring steel hardware in end caps and/or joiners

**Aircraft cable suspension** - 7x7 braids aluminum aircraft cable 0.06" thick

**Stem** - 0.5" diameter threaded steel tube matte white or aluminum powder coating. Custom finishes are also available.

### FINISH:

**Interior** - 95%, reflective matte powder coated white paint

**Exterior** - matte white powder coating

### ACOUSTIC FINISH:

Material is 100% polyester containing up to 50% of recycled plastic bottles (PET) with an ASTM E-84 Class A fire rating and is moisture resistant.

### CARE:

Remove dust and debris with a clean, dry, soft, lint-free cloth, or vacuum.

### ENVIRONMENT:

Ambient temperature at fixture location shall not exceed 30°C/86°F. For indoor use only.

### CERTIFICATIONS:

**ETL** - Rated for Indoor Dry/Damp locations. Conforms to UL Standard 1598 and certified to CAN/CSA Standard C22.2 No. 250.0.

### WARRANTY:

Lumenwerx provides a five-year limited warranty of electrical and mechanical performance of the luminaires, including the LED boards, drivers, and auxiliary electronics. Lumenwerx will repair or replace defective luminaires or components at our discretion, provided they have been installed and operated in accordance with our specifications. Other limitations apply, please refer to the full warranty on our website. Wall controllers are covered by the manufacturer warranty.

# AUDIA

ACOUSTIX - CHROMAWERX  
SOLA AND DUO



 Lumenwerx



**WELL for Light** - The WELL building standard focuses on light quality in several features. There are three categories that are fully attributed to the construction and features of a luminaire. In WELL V1, it's Feature 54 Circadian Lighting, Feature 55 Glare Control, and Feature 58 Color Quality. In WELL V2, it's Feature L03 Circadian Lighting, Feature L04 Glare Control, and Feature L07 Electric Light Quality.

This fixture meets Features:

- Feature 54 or L03 when DUO is selected
- Feature 55 or L04 meets WELL glare category (a-c-d)
- Feature 58 or L07 when 90CRI is selected

All LED drivers used at Lumenwerx are deemed to have a low risk level of flicker, of 5 % or less below 90Hz operational as defined by IEEE standard 1789-2015 LED.



**WELL for Sound** - This luminaire is recommended for use as an acoustical absorption surface to limit reverberation times (RT) in a given space. This luminaire contributes to noise reduction and vibration dampening to promote focus and concentration. Reverberation needs to be calculated in each space based on the materials used.



**WELL for Mind** - This luminaire meets WELL for mind as it is a human centric luminaire offering quality light, excellent color, smooth optics, and a sound diminishing element. If any of these features are incorporated in a luminaire, it can improve the ability to focus, concentrate, and persist longer on a given task. This fixture harmoniously operates in a space to assist the mind.

**For more information please contact [well@lumenwerx.com](mailto:well@lumenwerx.com).**



## Photometrics

Please follow the multiplier tables to ensure correct lumen value lensing CCT and CRI will change the lumen output.

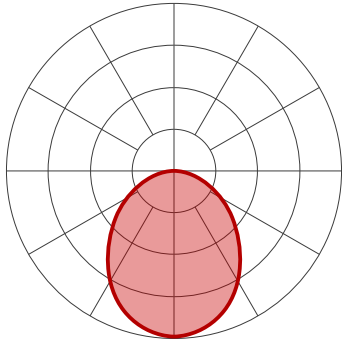

DIRECT

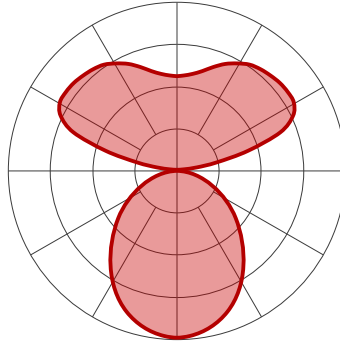

DIRECT/INDIRECT

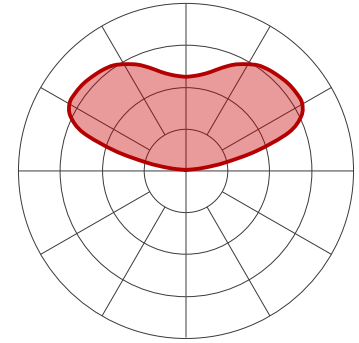

INDIRECT

### DIRECT

#### HLO-FH Delivered Lumens for Flush at 35K 80CRI

Lumens per Foot	Total Lumens Per 4FT	Input Watts	LPW
350	1400	19.5	72
500	2000	27	74
750	3000	41	73

### DIRECT

#### Multiplier - CCT/CRI

CCT (K)	Watts Multiplier		LPW Multiplier	
	CRI80	CRI90	CRI80	CRI90
2700	1.05	1.26	0.95	0.79
3000	1.01	1.23	0.99	0.81
3500	1.00	1.20	1.00	0.84
4000	1.00	1.17	1.00	0.85

### DIRECT/INDIRECT

#### HLO-FH-WIO2 Delivered Lumens for Flush at 35K 80CRI

Lumen Package (Direct + Indirect)	Direct	Indirect	Total Lumens Per 4FT	Input Watts	LPW
350+350	1400	1400	2800	32.47	86
350+500	1400	2000	3400	38.21	89
350+750	1400	3000	4400	47.04	94
500+350	2000	1400	3400	40.15	85
500+500	2000	2000	4000	45.89	87
500+750	2000	3000	5000	54.72	91
750+350	3000	1400	4400	54.47	81
750+500	3000	2000	5000	60.2	83

### DIRECT/INDIRECT

#### Multiplier - CCT/CRI

CCT (K)	Watts Multiplier		LPW Multiplier	
	CRI80	CRI90	CRI80	CRI90
2700	1.04	1.06	0.96	0.96
3000	1.01	1.09	0.97	0.92
3500	1.00	1.08	1.00	0.93
4000	0.98	1.06	1.02	0.95

### INDIRECT

#### WIO2 Delivered Lumens at 35K 80CRI

Lumens per Foot	Total Lumens Per 4FT	Input Watts	LPW
350	1400	13.11	107
500	2000	18.84	106
750	3000	27.67	108

### INDIRECT

#### Multiplier - CCT/CRI

CCT (K)	Watts Multiplier		LPW Multiplier	
	CRI80	CRI90	CRI80	CRI90
2700	1.04	1.06	0.96	0.96
3000	1.01	1.09	0.97	0.92
3500	1.00	1.08	1.00	0.93
4000	0.98	1.06	1.02	0.95



## DUO DMX SPECIFICATION

A qualified DMX integrator is required to assure proper installation and commissioning of the DMX network. **When placing the PO, please provide the contact information of your DMX integrator.**

Please answer the following questions to help us identify your DMX network requirements.

YES

Do you require a wall controller provided by Lumenwerx?

NO

DMX controller supplied by Lumenwerx

DMX control system supplied by others. Lumenwerx will supply DMX-enabled fixtures with default DMX addressing. See following pages for technical DMX informations. ✓

**How many zones do you have?**

A zone consists of one or more luminaires behaving identically.



1 Zone



2 Zones

**How to calculate the required number of drivers:**

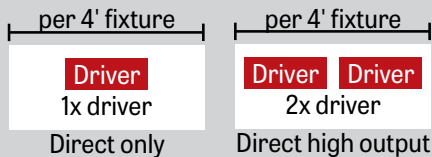

To Calculate # of drivers

1 - 4 Zones

5 or more Zones

Do you have more than 32 drivers in total?

NO

YES

Order a standard Lumenwerx wall controller.

### WALL CONTROLLER

**WCW** - wall controller white  
**WCB** - wall controller black

Add the control code at the end of your order code.

Please provide a fixture layout or RCP (Reflected Ceiling Plan) showing the locations of the DMX fixtures, zones and the DMX wall controller.

Refer to your DMX integrator for the installation. ✓

Subject to factory evaluation. Please contact our controls specialist at [controls@lumenwerx.com](mailto:controls@lumenwerx.com). Additional cost and equipment will be required. ✓

Subject to factory evaluation and approval. Please contact our controls specialist at [controls@lumenwerx.com](mailto:controls@lumenwerx.com). Additional cost and equipment will be required. ✓



## GENERIC DMX NETWORK ARCHITECTURE

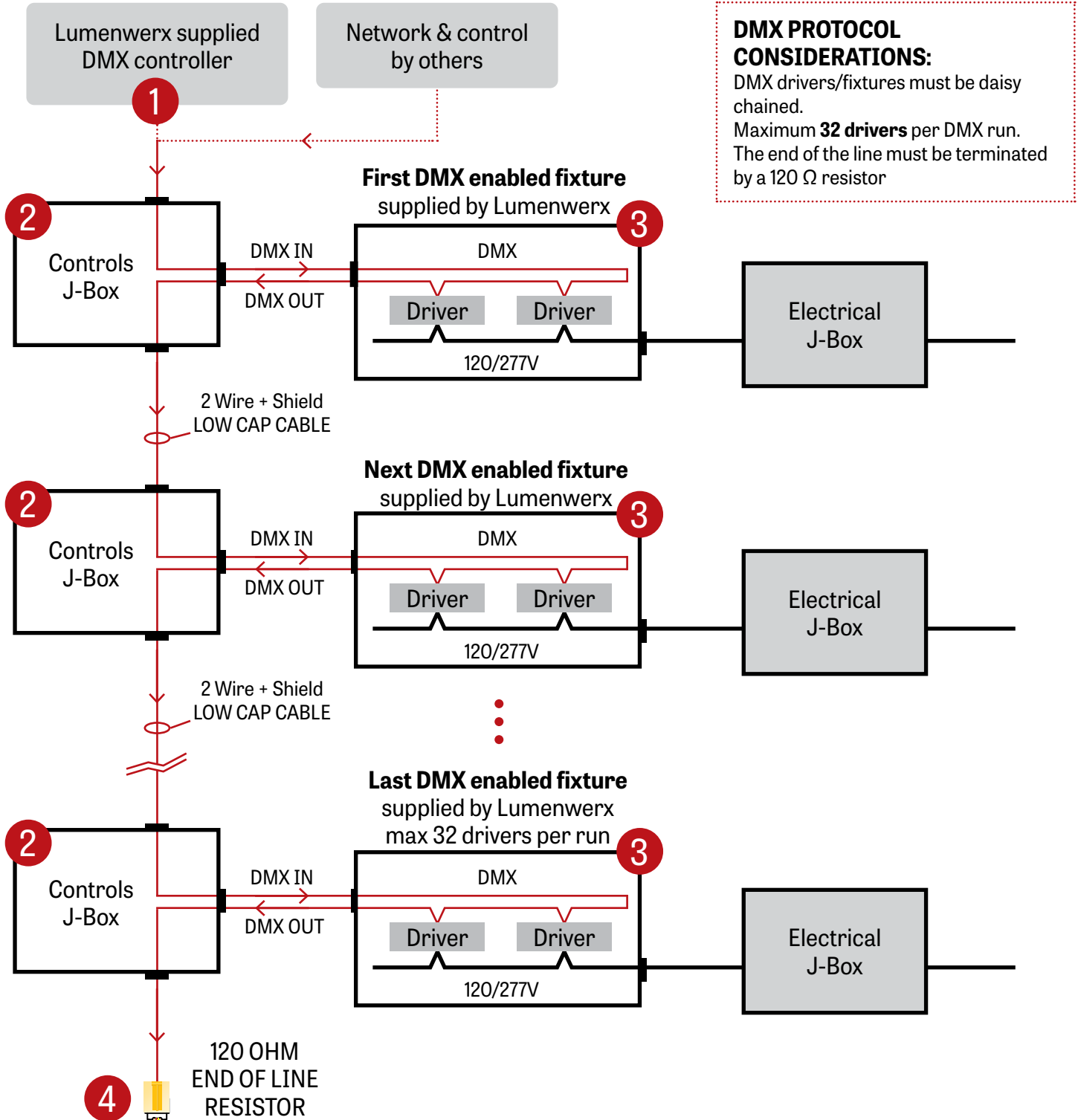



## 1 LUMENWERX SUPPLIED DMX CONTROLLER

To the first fixture



2 Wire +  
Shield Low Cap Cable

Back Panel

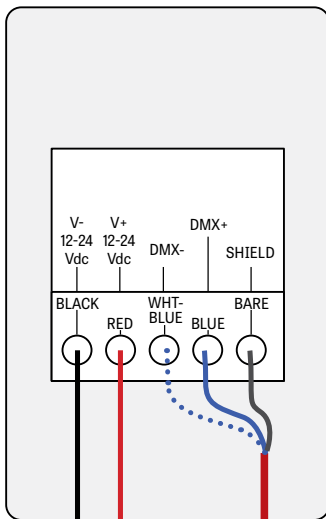

Front Panel

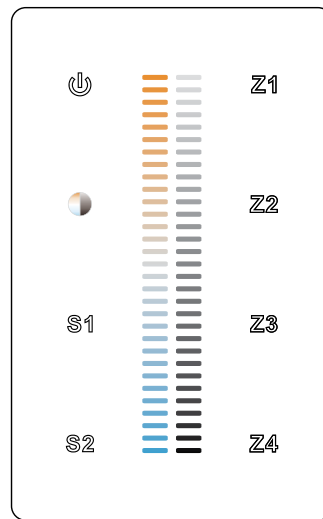

I.E.: Cerco Cable 7539-10  
Belden 9841  
Belden 8241

DC out

Power Supply  
120-277VAC / 24VDC

N  
L

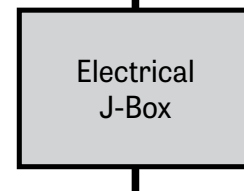
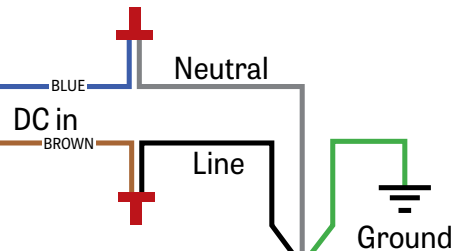

WALL BOX SUPPLIED BY OTHERS



## 2 J-BOX DMX DAISY CHAIN DETAIL

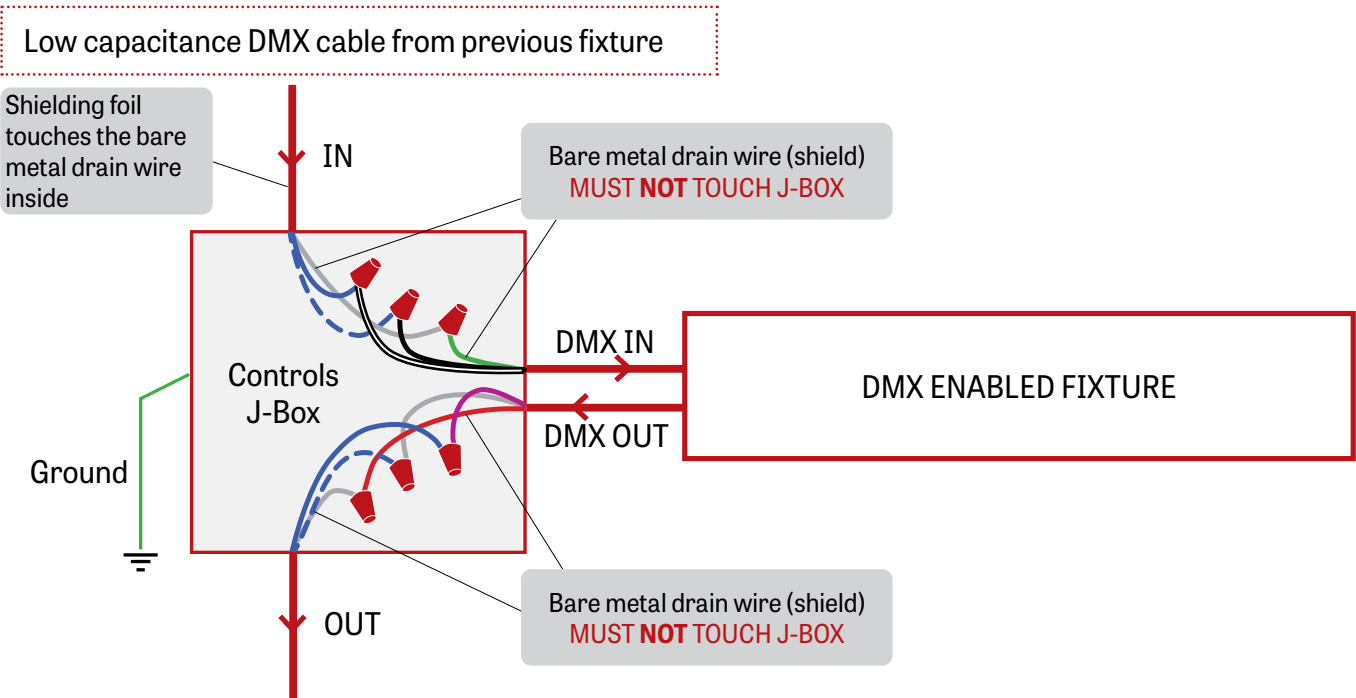

Low capacitance DMX cable to next fixture

## 3 DMX CONNECTION PENDANT & WALL

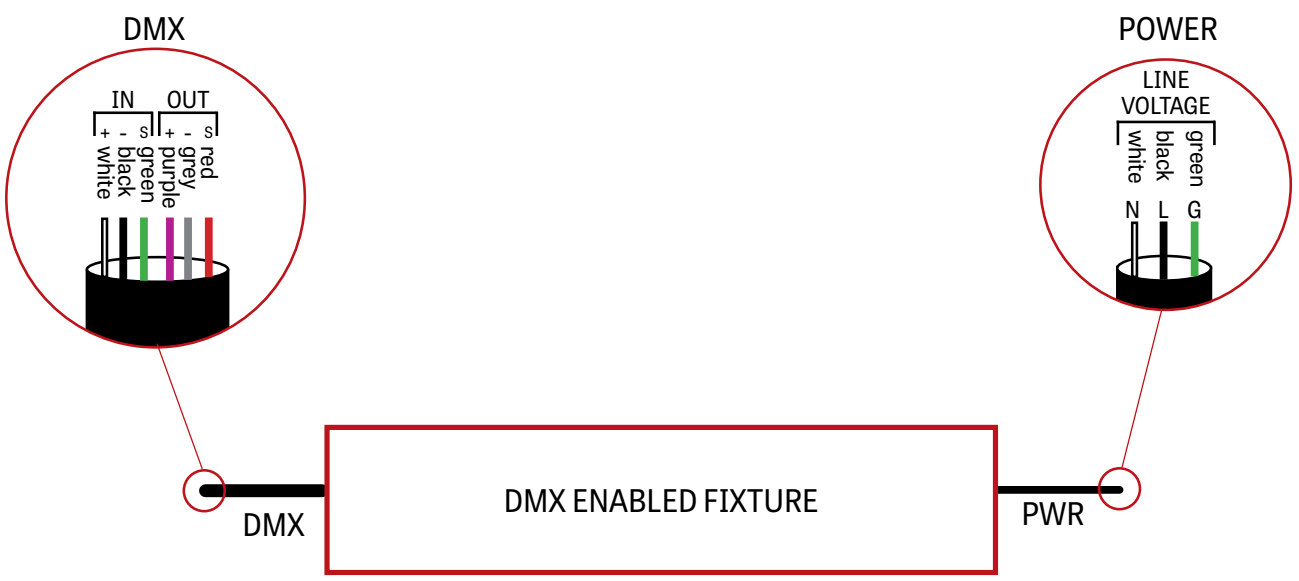



## 4 DMX LAST FIXTURE DETAIL

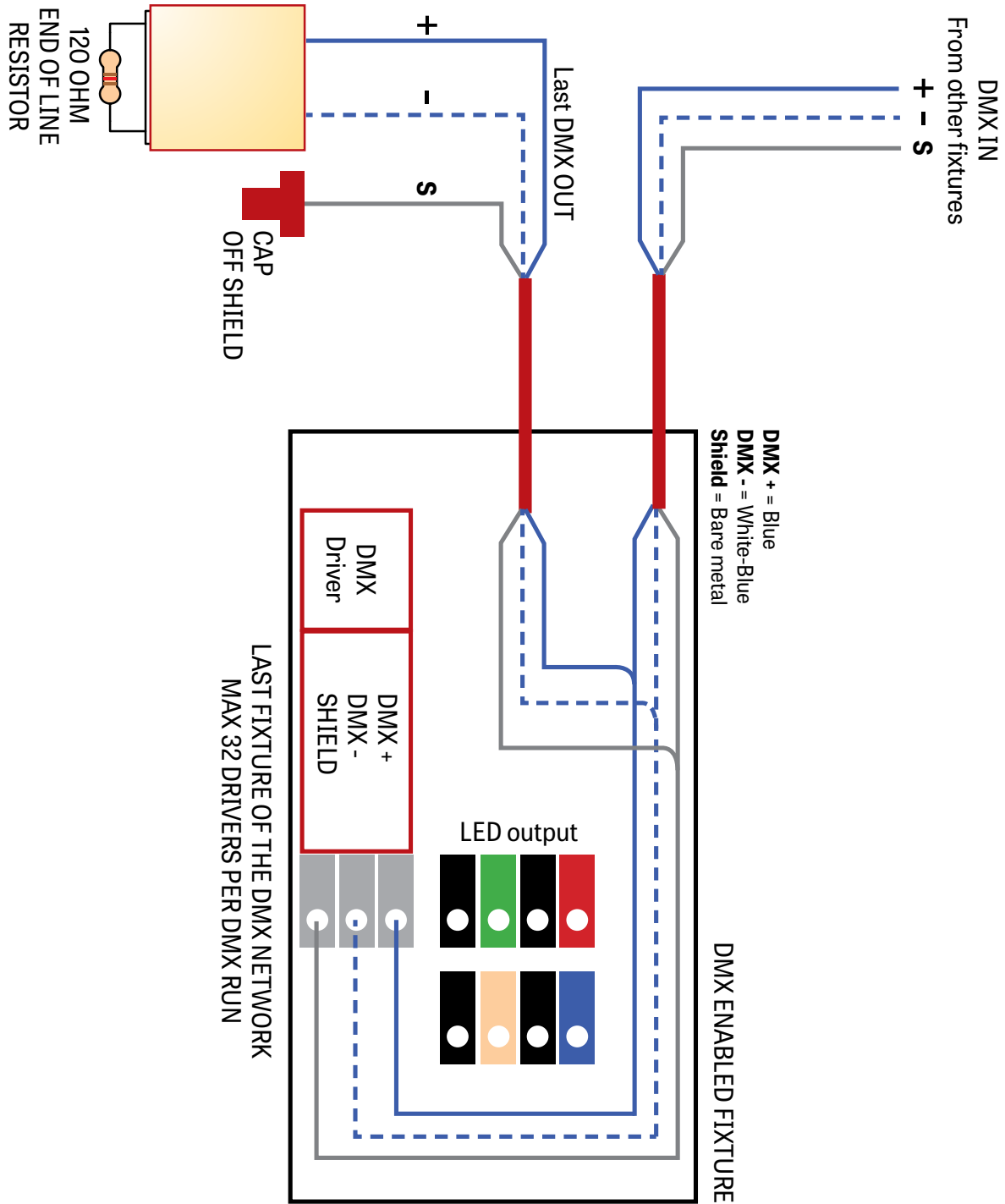



## DMX WALL CONTROLLER

### DUO 1-4 ZONE

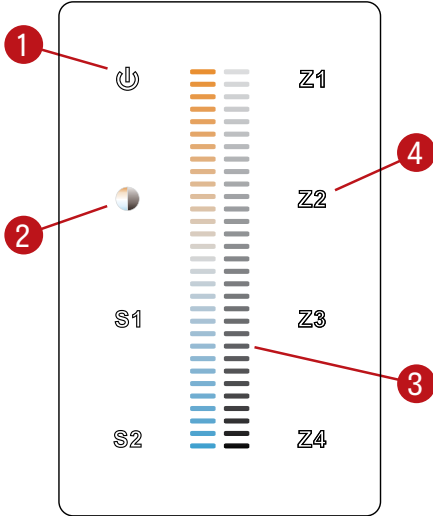

- (1) Power: Use this button to turn ON or OFF the fixture.
- (2) Brightness/CCT: Use the color/brightness toggle button to choose between color/brightness. When Blue: brightness is selected, when Yellow: color is selected.
- (3) Slider: Depending on the mode chosen in step 2, the slider will allow the user to set desired color or brightness.
- (4) Zone select: Up to 4 zones can be selected either independently or together. Once selected, the commands will be sent to the zone identified by a Blue LED.

### Default DMX Addresses:

- 1 Warm
- 2 Cool