

# CAVA CURVE LED

PENDANT DIRECT



**Lumenwerx**

## CHROMAWERX TUNABLE WHITE AND DIM TO WARM

**IMPORTANT: a qualified DMX integration consultant is required to ensure proper installation and function of any DMX network**

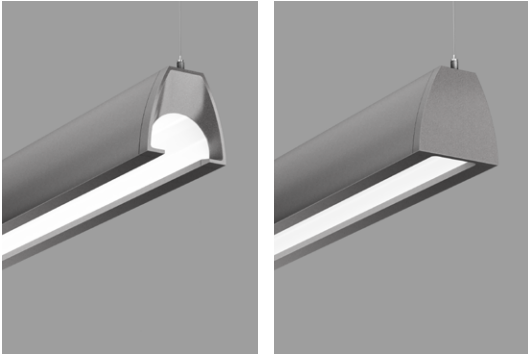

Shown with open end cap    Shown with closed end cap

### DESCRIPTION

**Cava** is a linear LED recessed, surface and pendant luminaire with a remarkably comfortable and surprising appearance. Using completely concealed and indirect LED arrays, Cava provides superior brightness control, while maintaining high efficacy by distributing light over the vaulted interior cavity of the luminaire. Cava is an ideal vehicle for ChromaWerx white tuning in education, office, and healthcare applications where modular luminaires are used.

**PROJECT:** \_\_\_\_\_  
 \_\_\_\_\_  
**TYPE:** \_\_\_\_\_  
**NOTES:** \_\_\_\_\_  
 \_\_\_\_\_

### ORDER GUIDE

**up to 122 lm/w performance**

| CAVCPD  | RLO                                      | LED                              |  |                          |  |   |
|---|--|----------------------------------|--|--------------------------|--|---|
| LUMINAIRE ID  | END CAP                                  | OPTICS                           | LIGHT SOURCE   | CRI                      | LUMEN PACKAGES   | CHROMAWERX  |
| CAVCPD - cava curve pendant direct  | OP - open end cap<br>CO - closed end cap | RLO - Reduced Luminance Optic    | LED - high performance LED   | 80 - 80CRI<br>90 - 90CRI | 350 - min. low output 350lm/ft<br>500 - medium output 500lm/ft<br>750 - max. high output 750lm/ft<br>#### - other required lm/ft | DUO - tunable white 2 channel control 27K to 65K<br>SOLA - dim to warm single channel control 22K to 35K  |
| LUMINAIRE LENGTH  | VOLTAGE                                  | DRIVER                           | ELECTRICAL   |                          | MOUNTING   |   |
| Available sections - 4', 8' & 12'<br>#FT - nominal length in feet<br><b>(2' increments only)</b><br>Continuous Run - for luminaires over 12'<br>Minimum Individual section 4' | 120 - 120V<br>277 - 277V                 | SOLA<br>SD1 - Single 0-10V input | DUO<br>DMX <sup>1,2</sup> - DMX<br>DDA <sup>2</sup> - DALI DT6<br>DDA8 <sup>2</sup> - DALI DT8<br>DD1 - Dual 0-10V input for CCT/intensity<br>LD2 <sup>2</sup> - Lutron DALI-2 digital | 1<br>1 - 1 circuit       | 5WAC36   | 53WAC36 - power 5" + non power 3" white canopy (36" air craft cable)<br><a href="#">For all other options refer to our Pendant Mounting Guide</a> |
|   |  |                                  | <sup>1</sup> For more information, see pages 4 to 9.   |                          |  |   |
|   |  |                                  | <sup>2</sup> On-site commissioning is required.  |                          |  |   |

See page 2 for ordering code detailed information

| FINISH  | OPTIONS  |
|---|--|
| W - matte white<br>AL - aluminum<br>B - matte black<br>CF# - custom finish specify RAL# | FU120 - Fuse 120V<br>FU277 - Fuse 277V<br>TB# - T-bar caddy clip specify grid size<br>TG# - Tegular caddy clip specify grid size<br>ST - Screw Slots caddy clip<br>CU - custom |

**DMX WALL CONTROLS**  
 To specify see pages 4 to 9

### CROSS SECTION

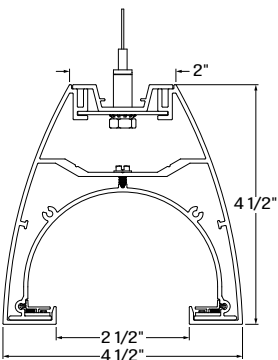

CAVCPD - air craft cable



### ANSI C78.377-2015

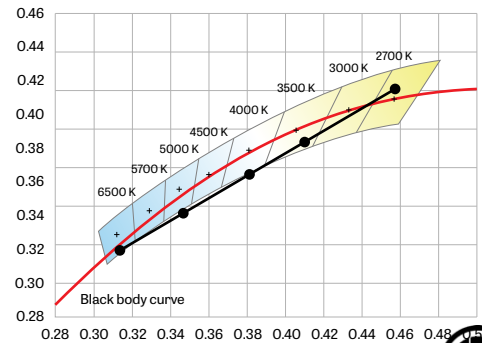

## CHROMAWERX TUNABLE WHITE AND DIM TO WARM

### OPTICS

**REDUCED LUMINANCE OPTIC (RLO)** - reduced Luminance Optic (RLO) consists of indirect-mounted LED arrays illuminating a vaulted reflector with a matte white finish greater than 95% reflectivity. The ultra-shallow arrays in RLO completely conceal the light source while evenly distributing brightness over the entire surface of the cavity using a combination of multiple reflective bounces and a very high diffuse reflectivity. Compared to diffusing optics, RLO reduces luminaire brightness due to the visible interior surface being larger than the aperture.

### LIGHT SOURCE - LED

#### PERFORMANCE PER 4' AT 4000K

| LED output    | Color Temp | Watts | Nominal Delivered Lumens | Efficacy LPW |
|---------------|------------|-------|--------------------------|--------------|
| low output    | 4000K      | 11.5  | 1400                     | 122          |
| medium output | 4000K      | 17    | 2000                     | 119          |
| high output   | 4000K      | 25    | 3000                     | 119          |

Custom linear array of alternating color temperature mid-flux LED's are mounted directly to the housing for optimal thermal performance. For the Duo products, a color temperature range from 2700K-6500K is achievable with color points on or below the black body curve. For the Sola products, a color temperature range from 2200K-3500K is controlled synchronously with intensity. Color consistency between fixtures is maintained to within 3SDCM. LEDs are operated at reduced drive current to optimize efficacy and lumen maintenance.

All LED's have been tested in accordance with IESNA LM-80-08 and the results have shown L80 lumen maintenance greater than 60,000 hours. Absolute product photometry is measured and presented in accordance with IESNA LM-79, unless otherwise indicated.

### LUMINAIRE LENGTH

Cava is made up of standard 4, 8 and 12 foot sections that may be joined together to create longer continuous run lengths. Exact run length must be noted in the product code. The minimum individual section available is 4 foot, and continuous run lengths can be ordered in 2 foot increments. All individual sections are joined together onsite using the joiner kits provided. LumenWerx offers joiner kits that are extremely simple to work with in the field and result in a fixture that appears virtually seamless with no light leak at any connection.

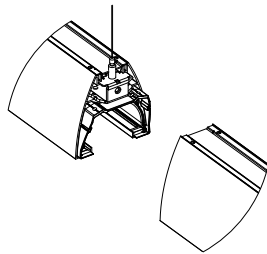

joining system for Cava curved

### CHROMAWERX - TUNABLE WHITE

#### ANSI C78.377-2015

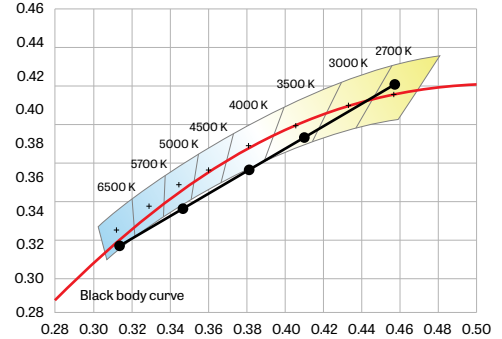

**Chromawerx Sola** is single-channel control that dims output while warming the color temperature in a pre-determined relationship. A simple digital or analog control sends a common signal to dual output digital drivers, which are programmed to adjust a specially populated LED array to emulate the effect of dimming a filament source. Dimming range is programmable but the default option runs from 3500K at 100% of full power to 2200K at 5% of full power. CRI is maintained above 80 throughout the dimming range.

**Chromawerx Duo** is two-channel control. It uses an analog (0-10V) protocol for separate control of luminaire CCT and intensity or a digital (DMX, DALI) protocol for synchronous control of both warm and cool LED arrays to enable the user to set color temperature and light output. Commonly called "tunable white", ChromaWerx two-channel control provides the range of warm (2700K) to cool (6500K) color that can be useful for helping to entrain circadian rhythms, stimulate alertness for improved educational and work productivity, and compensate for jet lag, among other applications. The Chromawerx drivers are programmed to limit maximum light output and power usage across all color temperatures. CRI is maintained above 80.

## CHROMAWERX TUNABLE WHITE AND DIM TO WARM

**ELECTRICAL****SOLA**SD1

Factory-set, adjustable output current LED driver with universal (120-277 VAC) input. Using a single 0-10V control signal, the light output warms in color temperature as it dims down to 1% and 2200K. At maximum driver load, efficiency<86%, PF>0.9, THD<20%.

**DUO**DMX

Factory-set adjustable output current electronic driver with 120-277 VAC line input. Using DMX wall controls (optionally supplied by Lumenwerx) or an existing DMX control system, both channels of LEDs are independently adjustable. Each DMX driver can be independently addressed using the built-in RDM (Remote Device Management) in the field. Dimming down to 1% is attainable. Rated life (90% survivorship) of 50,000 hours at 50°C maximum ambient temperature. At maximum driver load, efficiency<84%, PF>0.9, THD<20%.

DALI

Factory-set adjustable output current electronic driver with 120-277 VAC line input. Using an existing DALI control system (supplied by others), one control channel adjusts the fixture color temperature, and the other control channel adjusts fixture brightness. With DALI Type 6, two DALI addresses are required to control both channels. With DALI Type 8, one DALI address is required to control both channels. Dimming down to 1% is attainable. Rated life (90% survivorship) of 50,000 hours at 50°C maximum ambient temperature. At maximum driver load, efficiency<84%, PF>0.9, THD<20%.

DD1

Factory-set adjustable output current LED driver with universal (120-277 VAC) input. Controlled via two individual 0-10V signals, one for setting light output down to a minimum of 1% and the other for adjusting the CCT (default range of 6500K-2700K). Rated life of 50,000 hours at 70°C maximum driver case temperature and 100% load conditions. Typical efficiency of 86%, PF>0.9, THD<20% at 100% load conditions.

LD2

Lutron DALI-2 digital drivers provide a high-performance tunable white solution with single-address digital control. Guaranteed performance and compatibility when used with Lutron DALI-2 controls.

**MOUNTING OPTIONS**

Fixtures can be pendant-mounted, using aircraft cables.

Unless otherwise specified, LumenWerx provides the following hardware:

**For cable-mounted fixtures** - 53WAC36 (5" white canopy for all power mounting point, 3" white canopy for non power mounting point, and a 36" cable)

**Caddy clips**, if required specify under **OPTIONS**

[For all other options, see our website for a detailed Pendant Mounting Guide](#)

**FINISH**

**Interior** - 95%, reflective matte powder coated white paint

**Exterior** - matte white, matte black or aluminum powder coating.

Custom finishes are also available.

**CONSTRUCTION**

**Housing** - Extruded Aluminum 0.075" nominal, matte white or aluminum powder coating.

Custom finishes are also available.

**End cap** - Die cast Aluminum (0.95" nominal)

**Joiners** - Die cast Aluminum (0.95" nominal)

**Reflectors** - Extruded Aluminum 0.07" nominal, 95% reflective matte white painted

**Hanger** - Chromed Griplock securely attached with spring steel hardware in end caps and/or joiners

**Air craft cable suspension** - 7x7 braids Aluminum air craft cable 0.06" thick

**WEIGHT**

**Cava curved 4ft** - 11.78lbs - 5.35kg

**Cava curved 8ft** - 22.91lbs - 10.4kg

**Cava curved 12ft** - 34.14lbs - 15.5kg

**CERTIFICATIONS**

**ETL** - Rated for Indoor Dry/Damp locations.

Conforms to UL Standard 1598 and certified to CAN/CSA Standard C22.2 No. 250.0.

**WARRANTY**

For all ChromaWerx products, LumenWerx provides a three-year limited warranty of electrical and mechanical performance of the luminaires, including the LED boards, drivers, and auxiliary electronics.

LumenWerx will repair or replace defective luminaires or components at our discretion,

provided they have been installed and operated

in accordance with our specifications. Other

limitations apply, please refer to the full warranty on our website.

Wall controllers are covered by the manufacturer warranty.

## CHROMAWERX TUNABLE WHITE

### DUO DMX SPECIFICATION

A qualified DMX integrator is required to assure proper installation and commissioning of the DMX network. **When placing the PO, please provide the contact information of your DMX integrator.**

Please answer the following questions to help us identify your DMX network requirements.

YES

Do you require a wall controller provided by Lumenwerx?

NO

DMX control system supplied by others. Lumenwerx will supply DMX-enabled fixtures with default DMX addressing. See following pages for technical DMX informations.

DMX controller supplied by Lumenwerx

**How many zones do you have?**  
A zone consists of one or more luminaires behaving identically.

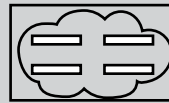

1 Zone



2 Zones

**How to calculate the required number of drivers:**

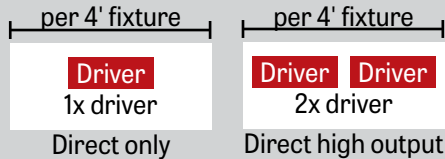

To Calculate # of drivers

1 - 4 Zones

5 or more Zones

Do you have more than 32 drivers in total?

NO

YES

Order a standard Lumenwerx wall controller.

#### WALL CONTROLLER

**WCW** - wall controller white  
**WCB** - wall controller black

Add the control code at the end of your order code.  
Please provide a fixture layout or RCP (Reflected Ceiling Plan) showing the locations of the DMX fixtures, zones and the DMX wall controller.  
Refer to your DMX integrator for the installation.

Subject to factory evaluation. Please contact our controls specialist at [controls@lumenwerx.com](mailto:controls@lumenwerx.com). Additional cost and equipment will be required.

Subject to factory evaluation and approval. Please contact our controls specialist at [controls@lumenwerx.com](mailto:controls@lumenwerx.com). Additional cost and equipment will be required.

## GENERIC DMX NETWORK ARCHITECTURE

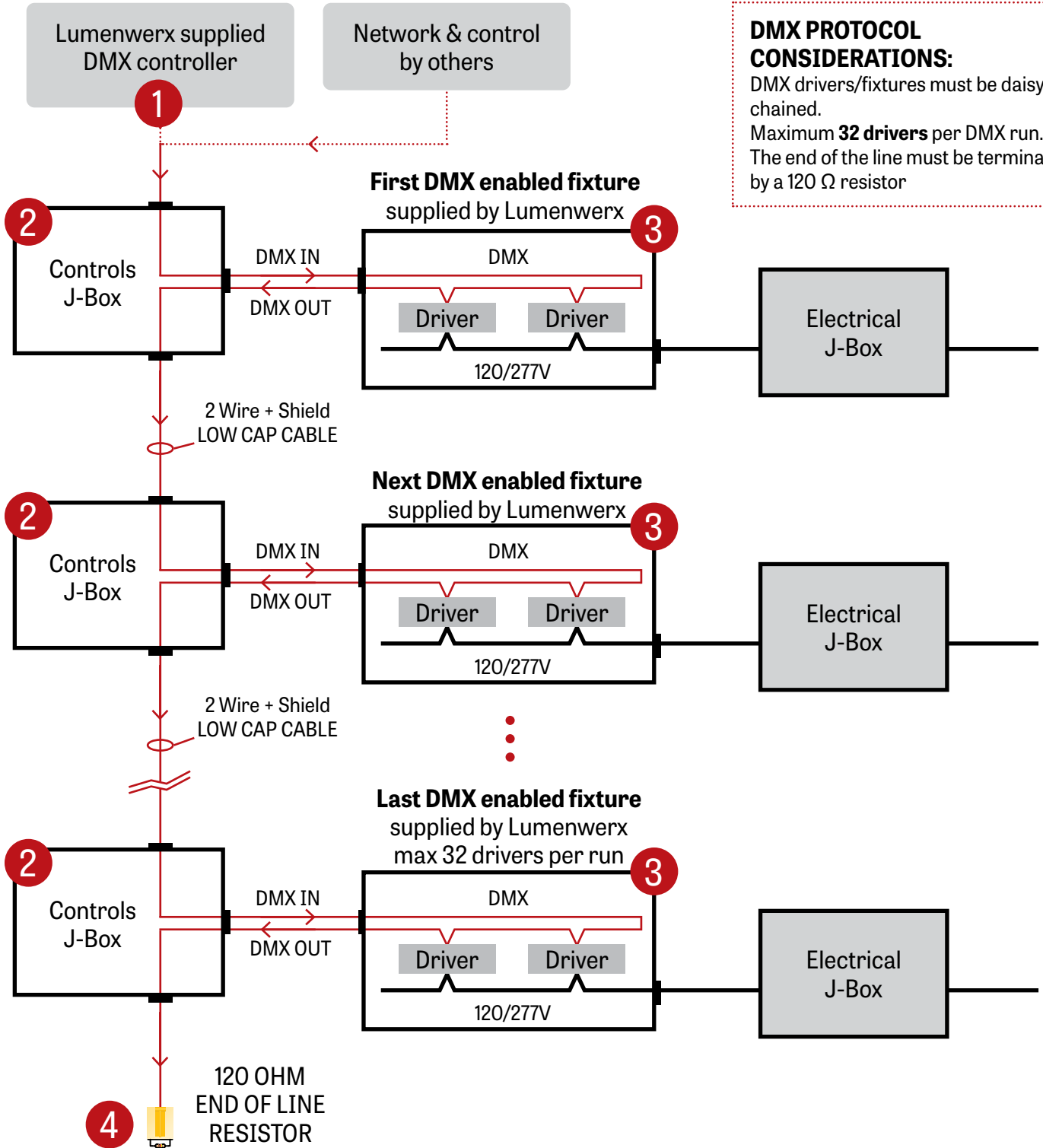

**DMX PROTOCOL CONSIDERATIONS:**  
 DMX drivers/fixtures must be daisy chained.  
 Maximum **32 drivers** per DMX run.  
 The end of the line must be terminated by a 120 Ω resistor

### CHROMAWERX TUNABLE WHITE

#### 1 LUMENWERX SUPPLIED DMX CONTROLLER

To the first fixture

WALL BOX SUPPLIED BY OTHERS

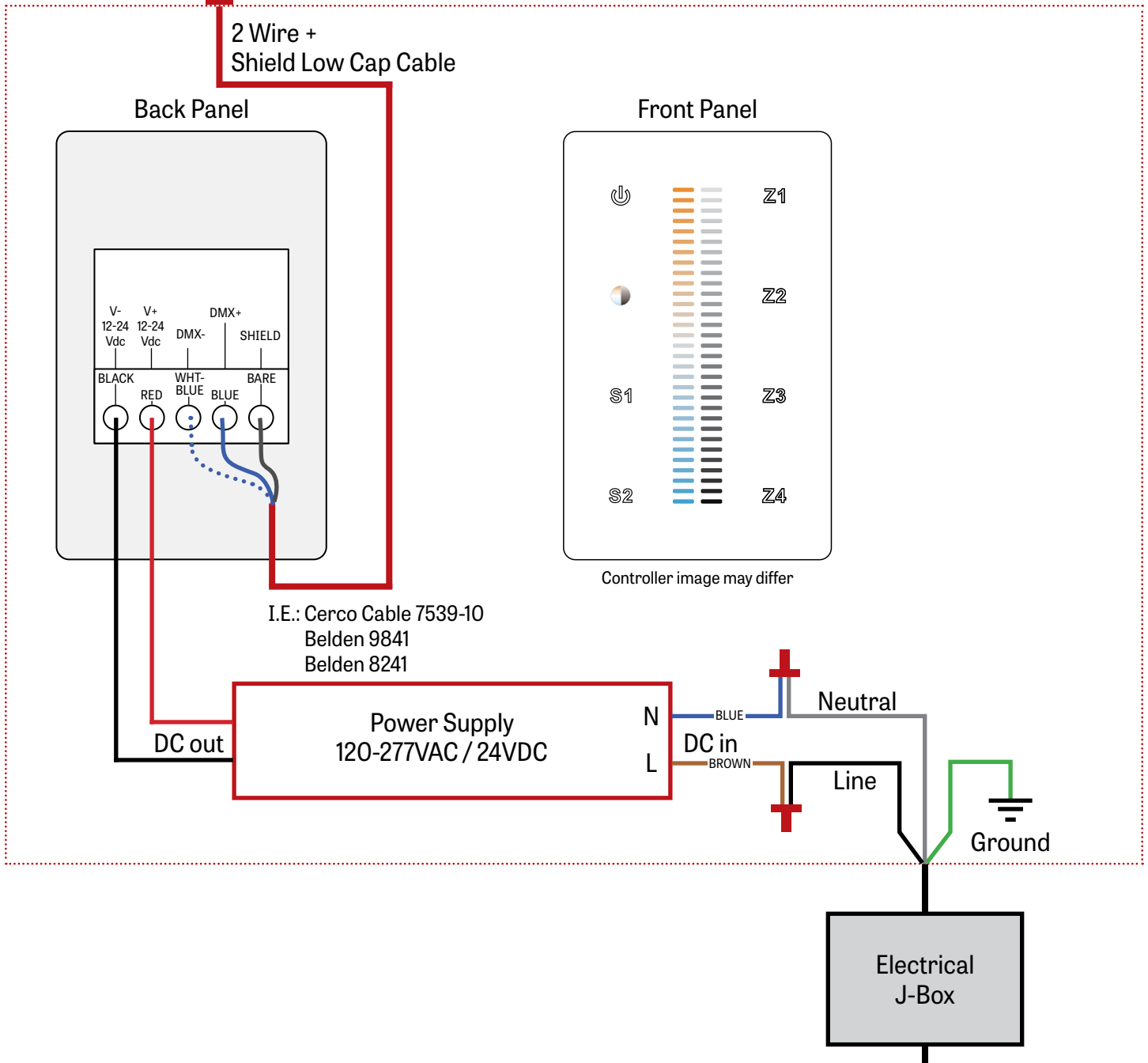

## CHROMAWERX TUNABLE WHITE

### 2 J-BOX DMX DAISY CHAIN DETAIL

#### Low capacitance DMX Cable from Previous Fixture

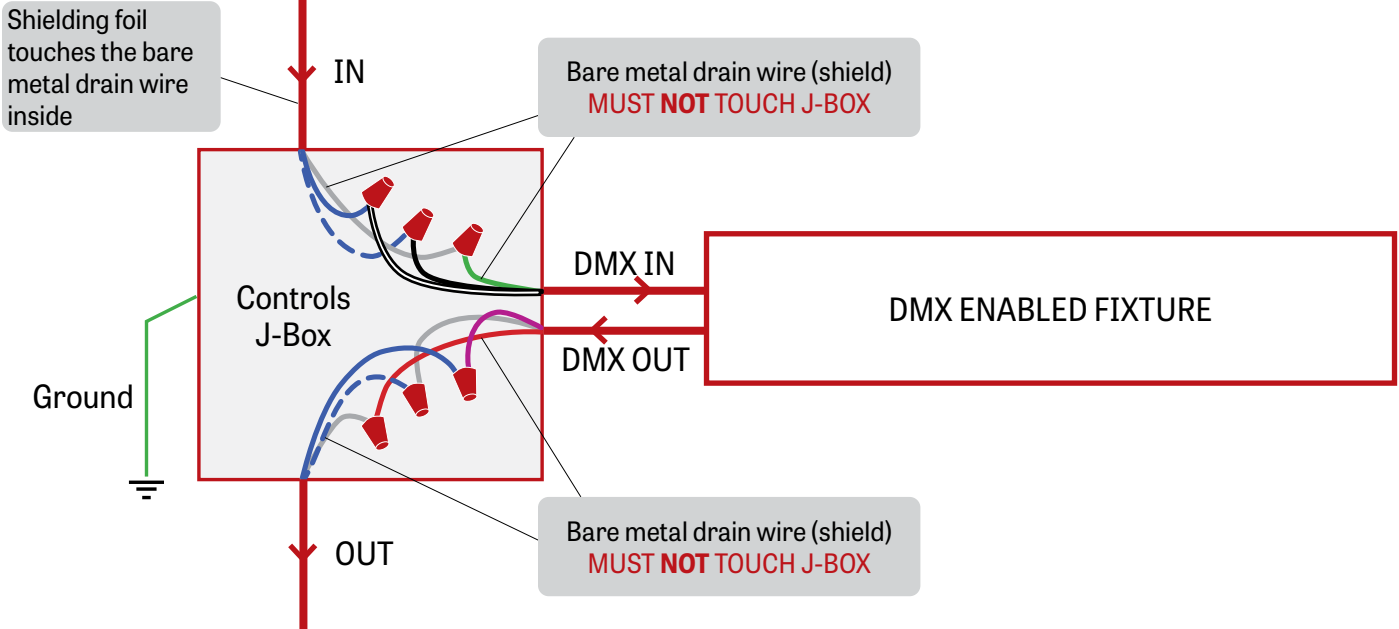

#### Low capacitance DMX cable to next fixture

### 3 DMX CONNECTION PENDANT & WALL

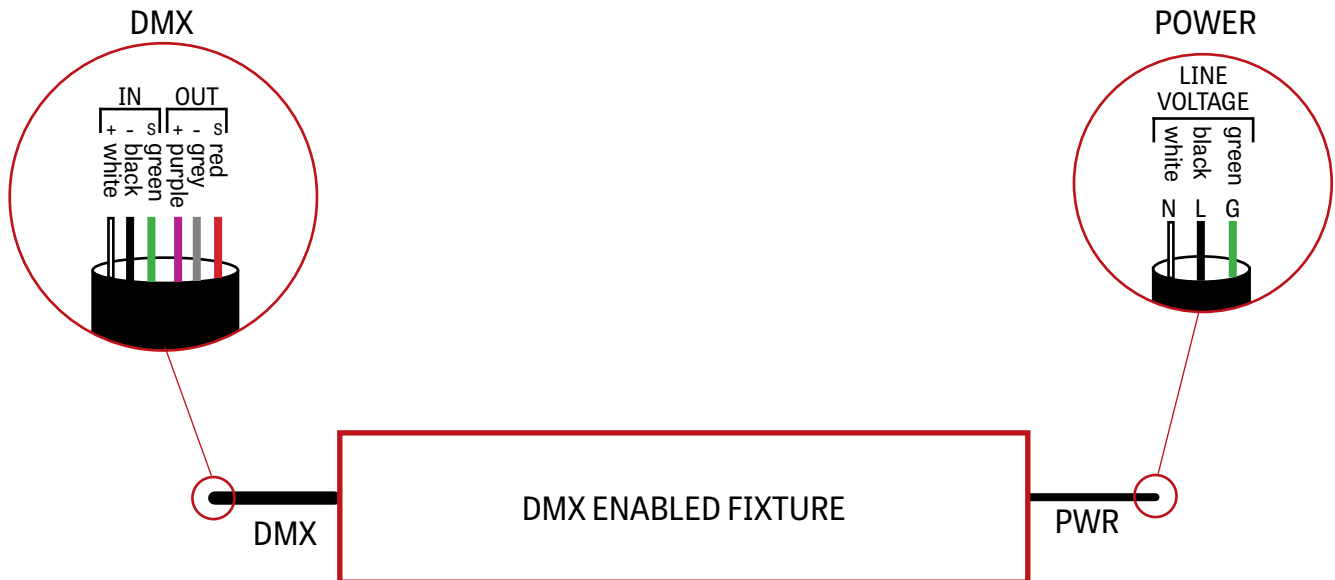

4 DMX LAST FIXTURE DETAIL

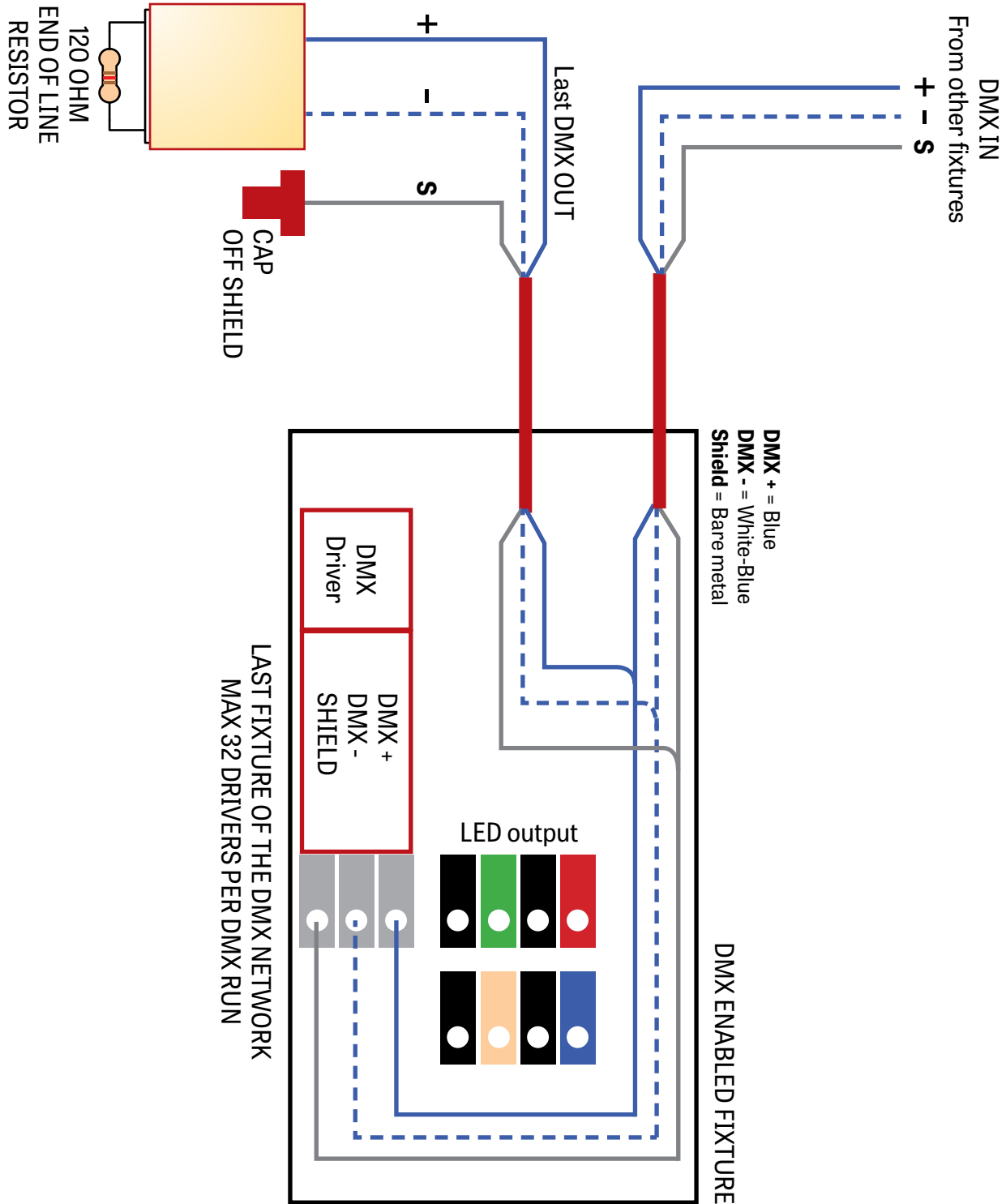

#### DUO 1-4 ZONE

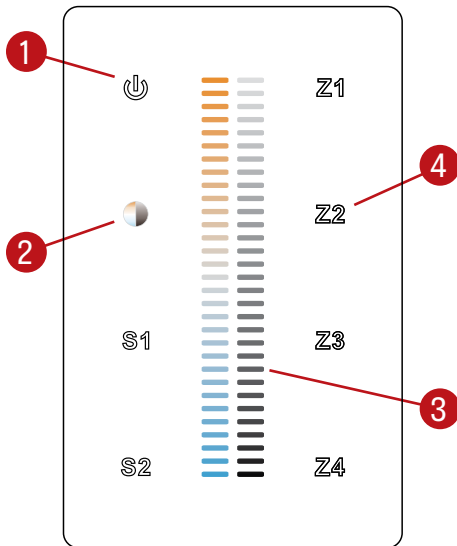

- (1) Power: Use this button to turn ON or OFF the fixture.
- (2) Brightness/CCT: Use the color/brightness toggle button to choose between color/brightness. When Blue: brightness is selected, when Yellow: color is selected.
- (3) Slider: Depending on the mode chosen in step 2, the slider will allow the user to set desired color or brightness.
- (4) Zone select: Up to 4 zones can be selected either independently or together. Once selected, the commands will be sent to the zone identified by a Blue LED.

#### Default DMX Addresses:

- 1 Warm
- 2 Cool

# CAVA CURVE LED

PENDANT DIRECT



## CHROMAWERX TUNABLE WHITE AND DIM TO WARM

### 350 LUMEN AT 80CRI - LOW OUTPUT

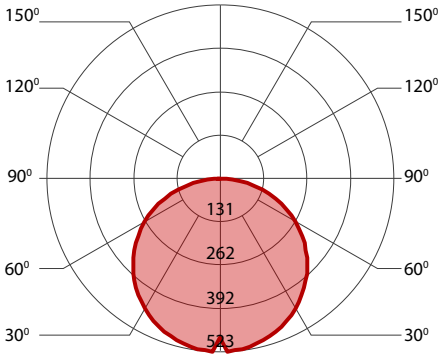

#### PERFORMANCE PER 4'

| LED output | Color Temp | Watts | Nominal Delivered Lumens | Efficacy LPW |
|------------|------------|-------|--------------------------|--------------|
| low output | 2700K      | 12.5  | 1400                     | 112          |
| low output | 3000K      | 12    | 1400                     | 116          |
| low output | 3500K      | 12    | 1400                     | 118          |
| low output | 4000K      | 11.5  | 1400                     | 122          |
| low output | 6500K      | 11    | 1400                     | 127          |

### 500 LUMEN AT 80CRI - MEDIUM OUTPUT

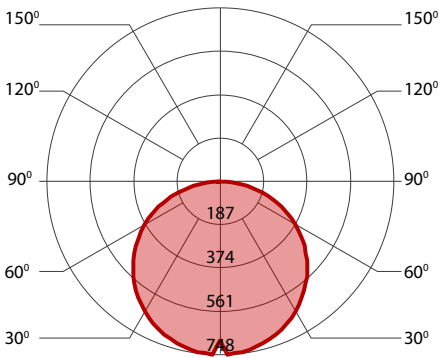

#### PERFORMANCE PER 4'

| LED output    | Color Temp | Watts | Nominal Delivered Lumens | Efficacy LPW |
|---------------|------------|-------|--------------------------|--------------|
| medium output | 2700K      | 18.5  | 2000                     | 109          |
| medium output | 3000K      | 17.5  | 2000                     | 113          |
| medium output | 3500K      | 17.5  | 2000                     | 115          |
| medium output | 4000K      | 17    | 2000                     | 119          |
| medium output | 6500K      | 16    | 2000                     | 124          |

### 750 LUMEN AT 80CRI - HIGH OUTPUT

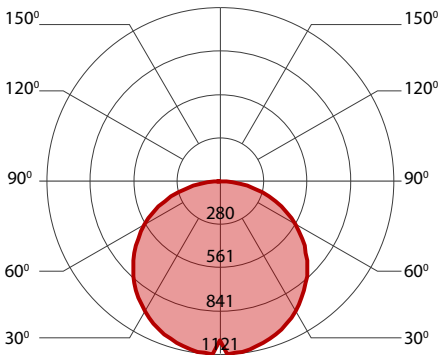

#### PERFORMANCE PER 4'

| LED output  | Color Temp | Watts | Nominal Delivered Lumens | Efficacy LPW |
|-------------|------------|-------|--------------------------|--------------|
| high output | 2700K      | 27.5  | 3000                     | 110          |
| high output | 3000K      | 26.5  | 3000                     | 113          |
| high output | 3500K      | 26    | 3000                     | 116          |
| high output | 4000K      | 25    | 3000                     | 119          |
| high output | 6500K      | 24    | 3000                     | 124          |