

CAVA SQUARE LED

PENDANT DIRECT



CHROMAWERX TUNABLE WHITE AND DIM TO WARM

IMPORTANT: a qualified DMX integration consultant is required to ensure proper installation and function of any DMX network

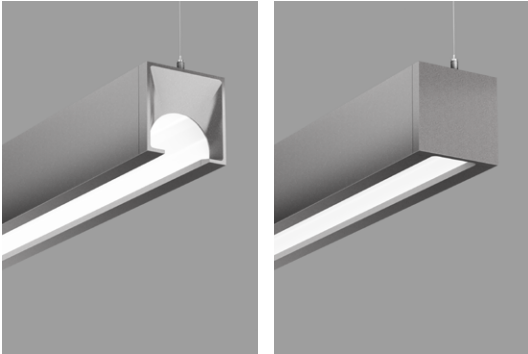

Shown with open end cap Shown with closed end cap

DESCRIPTION

Cava is a linear LED recessed, surface and pendant luminaire with a remarkably comfortable and surprising appearance. Using completely concealed and indirect LED arrays, Cava provides superior brightness control, while maintaining high efficacy by distributing light over the vaulted interior cavity of the luminaire. Cava is an ideal vehicle for ChromaWerx white tuning in education, office, and healthcare applications where modular luminaires are used.

PROJECT: _____

TYPE: _____

NOTES: _____

ORDER GUIDE

up to 122 lm/w performance

CAVSPD	RLO	LED				
LUMINAIRE ID	END CAP	OPTICS	LIGHT SOURCE	CRI	LUMEN PACKAGES	CHROMAWERX
CAVSPD - cava square pendant direct	OP - open end cap CO - closed end cap	RLO - Reduced Luminance Optic	LED - high performance LED	80 - 80CRI 90 - 90CRI	350 - min. low output 350lm/ft 500 - medium output 500lm/ft 750 - max. high output 750lm/ft #### - other required lm/ft	DUO - tunable white 2 channel control 27k to 65k SOLA - dim to warm single channel control 22k to 35k
LUMINAIRE LENGTH	VOLTAGE	DRIVER			1	5WAC36
Available sections - 4', 8' & 12' #FT - nominal length in feet (2' increments only) Continuous Run - for luminaires over 12' Minimum Individual section 4'	120 - 120V 277 - 277V	SOLA SD1 - Single 0-10V input ¹ For more information, see pages 4 to 9. ² On-site commissioning is required.	DUO DMX ^{1,2} - DMX DDA ² - DALI DT6 DDA8 ² - DALI DT8 DD1 - Dual 0-10V input for CCT/intensity LD2 ² - Lutron DALI-2 digital		1 - 1 circuit	53WAC36 - power 5" + non power 3" white canopy (36" air craft cable) For all other options refer to our Pendant Mounting Guide

See page 2 for ordering code detailed information

FINISH	OPTIONS
W - matte white AL - aluminum B - matte black CF# - custom finish specify RAL#	FU120 - Fuse 120V FU277 - Fuse 277V TB# - T-bar caddy clip specify grid size TG# - Tegular caddy clip specify grid size ST - Screw Slots caddy clip CU - custom

DMX WALL CONTROLS
To specify see pages 4 to 9

CROSS SECTION

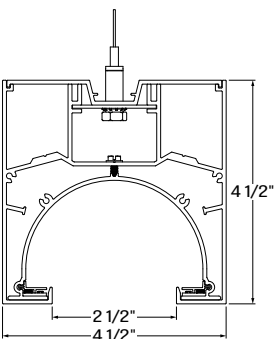

CAVSPD - air craft cable



ANSI C78.377-2015

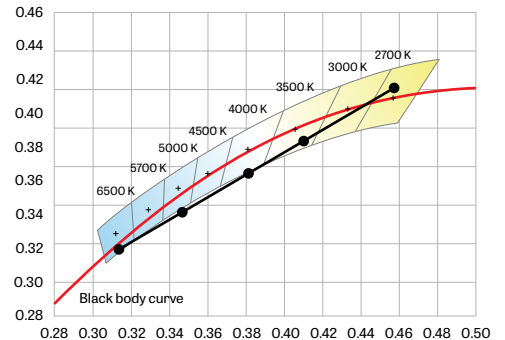

CHROMAWERX TUNABLE WHITE AND DIM TO WARM

OPTICS

REDUCED LUMINANCE OPTIC (RLO) - reduced Luminance Optic (RLO) consists of indirect-mounted LED arrays illuminating a vaulted reflector with a matte white finish greater than 95% reflectivity. The ultra-shallow arrays in RLO completely conceal the light source while evenly distributing brightness over the entire surface of the cavity using a combination of multiple reflective bounces and a very high diffuse reflectivity. Compared to diffusing optics, RLO reduces luminaire brightness due to the visible interior surface being larger than the aperture.

LIGHT SOURCE - LED

PERFORMANCE PER 4' AT 4000K

LED output	Color Temp	Watts	Nominal Delivered Lumens	Efficacy LPW
low output	4000K	11.5	1400	122
medium output	4000K	17	2000	119
high output	4000K	25	3000	119

Custom linear array of alternating color temperature mid-flux LED's are mounted directly to the housing for optimal thermal performance. For the Duo products, a color temperature range from 2700K-6500K is achievable with color points on or below the black body curve. For the Sola products, a color temperature range from 2200K-3500K is controlled synchronously with intensity. Color consistency between fixtures is maintained to within 3SDCM. LEDs are operated at reduced drive current to optimize efficacy and lumen maintenance.

All LED's have been tested in accordance with IESNA LM-80-08 and the results have shown L80 lumen maintenance greater than 60,000 hours. Absolute product photometry is measured and presented in accordance with IESNA LM-79, unless otherwise indicated.

LUMINAIRE LENGTH

Cava is made up of standard 4, 8 and 12 foot sections that may be joined together to create longer continuous run lengths. Exact run length must be noted in the product code. The minimum individual section available is 4 foot, and continuous run lengths can be ordered in 2 foot increments. All individual sections are joined together onsite using the joiner kits provided. LumenWerx offers joiner kits that are extremely simple to work with in the field and result in a fixture that appears virtually seamless with no light leak at any connection.

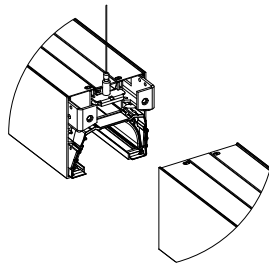

joining system for Cava square

CHROMAWERX - TUNABLE WHITE

ANSI C78.377-2015

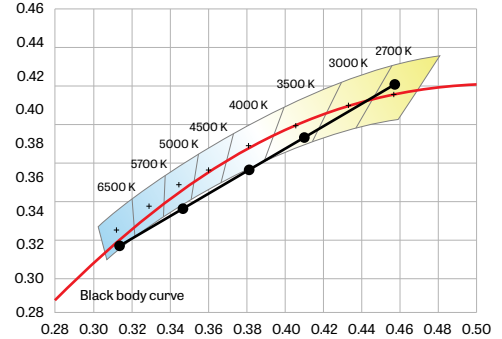

Chromawerx Sola is single-channel control that dims output while warming the color temperature in a pre-determined relationship. A simple digital or analog control sends a common signal to dual output digital drivers, which are programmed to adjust a specially populated LED array to emulate the effect of dimming a filament source. Dimming range is programmable but the default option runs from 3500K at 100% of full power to 2200K at 5% of full power. CRI is maintained above 80 throughout the dimming range.

Chromawerx Duo is two-channel control. It uses an analog (0-10V) protocol for separate control of luminaire CCT and intensity or a digital (DMX, DALI) protocol for synchronous control of both warm and cool LED arrays to enable the user to set color temperature and light output. Commonly called "tunable white", ChromaWerx two-channel control provides the range of warm (2700K) to cool (6500K) color that can be useful for helping to entrain circadian rhythms, stimulate alertness for improved educational and work productivity, and compensate for jet lag, among other applications. The ChromaWerx drivers are programmed to limit maximum light output and power usage across all color temperatures. CRI is maintained above 80.

CHROMAWERX TUNABLE WHITE AND DIM TO WARM

ELECTRICAL**SOLA**SD1

Factory-set, adjustable output current LED driver with universal (120-277 VAC) input. Using a single 0-10V control signal, the light output warms in color temperature as it dims down to 1% and 2200K. At maximum driver load, efficiency<86%, PF>0.9, THD<20%.

DUODMX

Factory-set adjustable output current electronic driver with 120-277 VAC line input. Using DMX wall controls (optionally supplied by Lumenwerx) or an existing DMX control system, both channels of LEDs are independently adjustable. Each DMX driver can be independently addressed using the built-in RDM (Remote Device Management) in the field. Dimming down to 1% is attainable. Rated life (90% survivorship) of 50,000 hours at 50°C maximum ambient temperature. At maximum driver load, efficiency<84%, PF>0.9, THD<20%.

DALI

Factory-set adjustable output current electronic driver with 120-277 VAC line input. Using an existing DALI control system (supplied by others), one control channel adjusts the fixture color temperature, and the other control channel adjusts fixture brightness. With DALI Type 6, two DALI addresses are required to control both channels. With DALI Type 8, one DALI address is required to control both channels. Dimming down to 1% is attainable. Rated life (90% survivorship) of 50,000 hours at 50°C maximum ambient temperature. At maximum driver load, efficiency<84%, PF>0.9, THD<20%.

DD1

Factory-set adjustable output current LED driver with universal (120-277 VAC) input. Controlled via two individual 0-10V signals, one for setting light output down to a minimum of 1% and the other for adjusting the CCT (default range of 6500K-2700K). Rated life of 50,000 hours at 70°C maximum driver case temperature and 100% load conditions. Typical efficiency of 86%, PF>0.9, THD<20% at 100% load conditions.

LD2

Lutron DALI-2 digital drivers provide a high-performance tunable white solution with single-address digital control. Guaranteed performance and compatibility when used with Lutron DALI-2 controls.

MOUNTING OPTIONS

Fixtures can be pendant-mounted, using aircraft cables.

Unless otherwise specified, LumenWerx provides the following hardware:

For cable-mounted fixtures - 53WAC36 (5" white canopy for all power mounting point, 3" white canopy for non power mounting point, and a 36" cable)

Caddy clips, if required specify under **OPTIONS**

[For all other options, see our website for a detailed Pendant Mounting Guide](#)

FINISH

Interior - 95%, reflective matte powder coated white paint

Exterior - matte white, matte black or aluminum powder coating.

Custom finishes are also available.

CONSTRUCTION

Housing - Extruded Aluminum 0.075" nominal, matte white or aluminum powder coating.

Custom finishes are also available.

End cap - Die cast Aluminum (0.95" nominal)

Joiners - Die cast Aluminum (0.95" nominal)

Reflectors - Extruded Aluminum 0.07" nominal, 95% reflective matte white painted

Hanger - Chromed Griplock securely attached with spring steel hardware in end caps and/or joiners

Air craft cable suspension - 7x7 braids Aluminum air craft cable 0.06" thick

WEIGHT

Cava square 4ft - 14.10lbs - 6.4kg

Cava square 8ft - 27.53lbs - 12.5kg

Cava square 12ft - 40.97lbs - 18.6kg

CERTIFICATIONS

ETL - Rated for Indoor Dry/Damp locations.

Conforms to UL Standard 1598 and certified to CAN/CSA Standard C22.2 No. 250.0.

WARRANTY

For all ChromaWerx products, LumenWerx provides a three-year limited warranty of electrical and mechanical performance of the luminaires, including the LED boards, drivers, and auxiliary electronics.

LumenWerx will repair or replace defective luminaires or components at our discretion, provided they have been installed and operated in accordance with our specifications. Other limitations apply, please refer to the full warranty on our website.

Wall controllers are covered by the manufacturer warranty.

CHROMAWERX TUNABLE WHITE

DUO DMX SPECIFICATION

A qualified DMX integrator is required to assure proper installation and commissioning of the DMX network. **When placing the PO, please provide the contact information of your DMX integrator.**

Please answer the following questions to help us identify your DMX network requirements.

YES

Do you require a wall controller provided by Lumenwerx?

NO

DMX control system supplied by others. Lumenwerx will supply DMX-enabled fixtures with default DMX addressing. See following pages for technical DMX informations. ✓

DMX controller supplied by Lumenwerx

How many zones do you have?

A zone consists of one or more luminaires behaving identically.

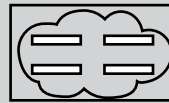

1 Zone



2 Zones

How to calculate the required number of drivers:

per 4' fixture

Driver

1x driver

Direct only

per 4' fixture

Driver

Driver

2x driver

Direct high output

To Calculate # of drivers

1 - 4 Zones

5 or more Zones

Do you have more than 32 drivers in total?

NO

YES

Order a standard Lumenwerx wall controller.

WALL CONTROLLER

WCW - wall controller white

WCB - wall controller black

Add the control code at the end of your order code.

Please provide a fixture layout or RCP (Reflected Ceiling Plan) showing the locations of the DMX fixtures, zones and the DMX wall controller.

Refer to your DMX integrator for the installation. ✓

Subject to factory evaluation. Please contact our controls specialist at controls@lumenwerx.com. Additional cost and equipment will be required. ✓

Subject to factory evaluation and approval. Please contact our controls specialist at controls@lumenwerx.com. Additional cost and equipment will be required. ✓

CAVA SQUARE LED

PENDANT DIRECT



CHROMAWERX TUNABLE WHITE

GENERIC DMX NETWORK ARCHITECTURE

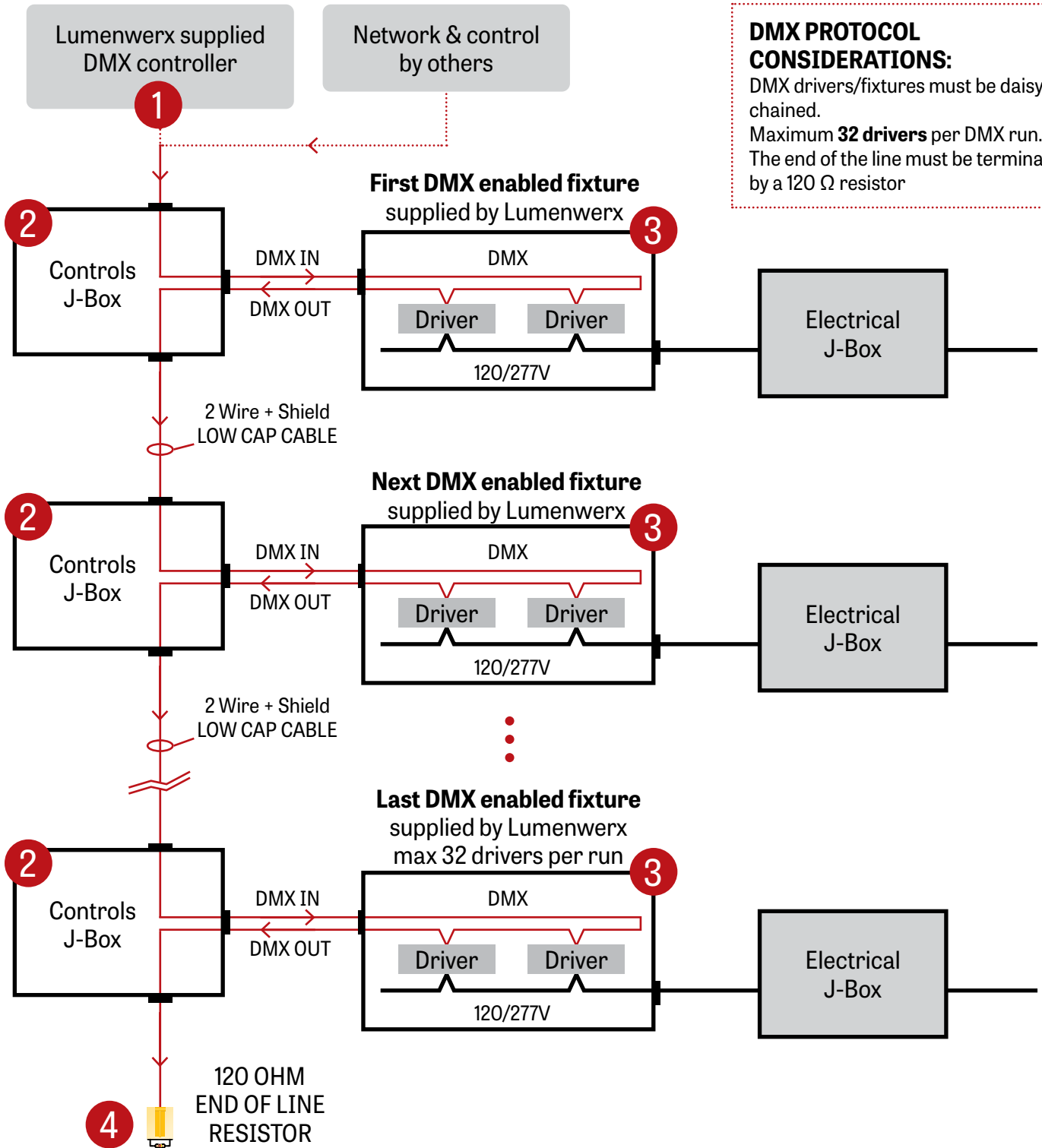

DMX PROTOCOL CONSIDERATIONS:
DMX drivers/fixtures must be daisy chained.
Maximum **32 drivers** per DMX run.
The end of the line must be terminated by a 120 Ω resistor



1 LUMENWERX SUPPLIED DMX CONTROLLER

To the first fixture

WALL BOX SUPPLIED BY OTHERS

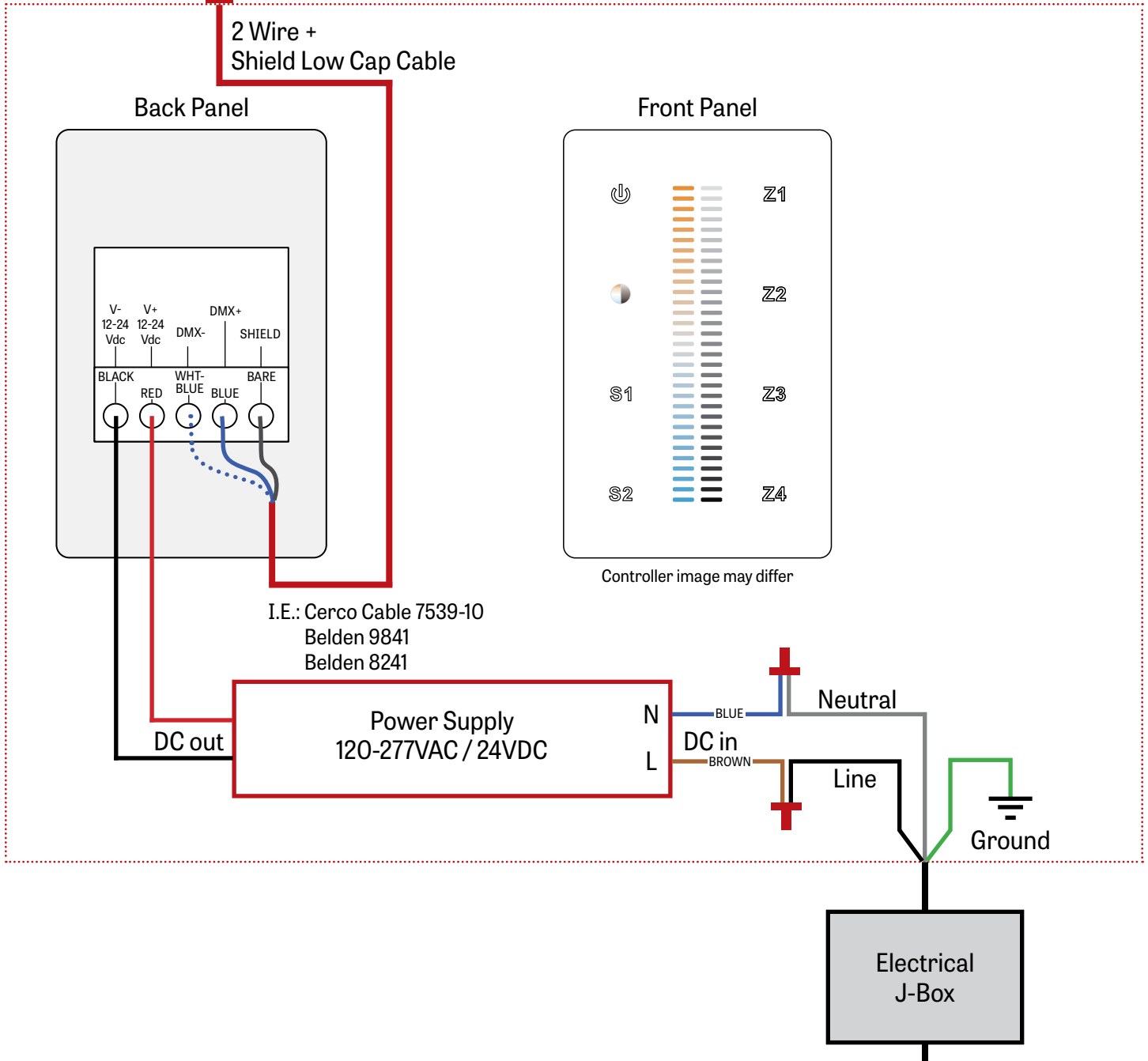

2 J-BOX DMX DAISY CHAIN DETAIL

Low capacitance DMX Cable from Previous Fixture

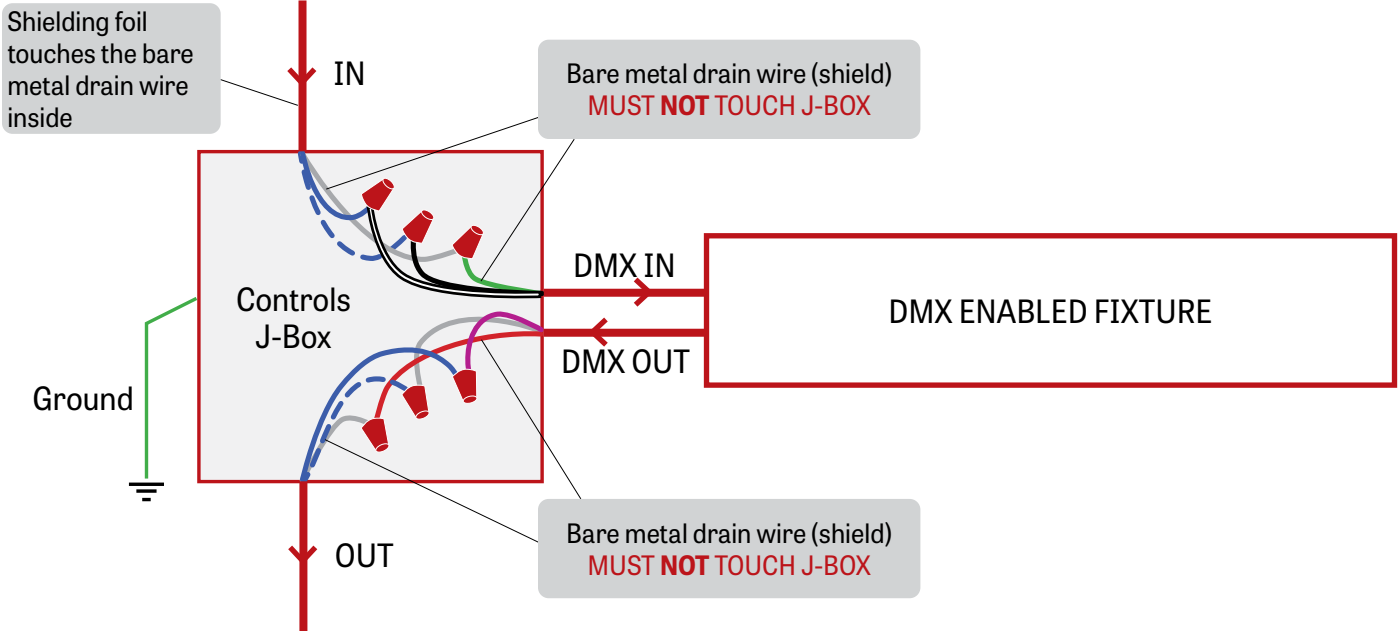

Low capacitance DMX cable to next fixture

3 DMX CONNECTION PENDANT & WALL

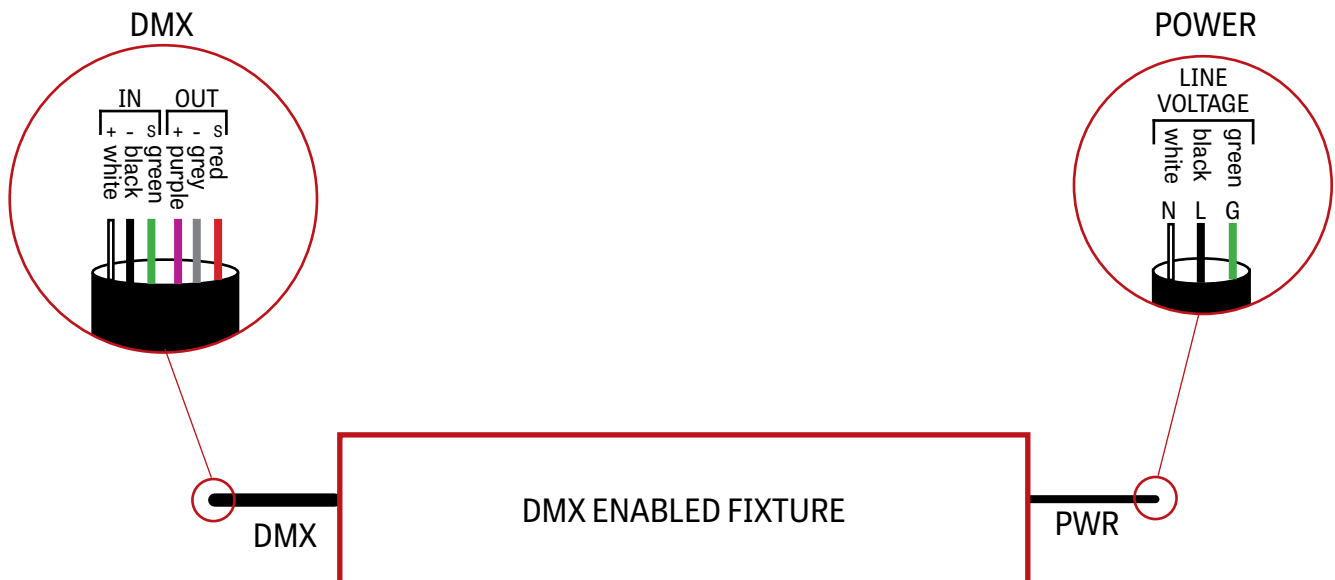

4 DMX LAST FIXTURE DETAIL

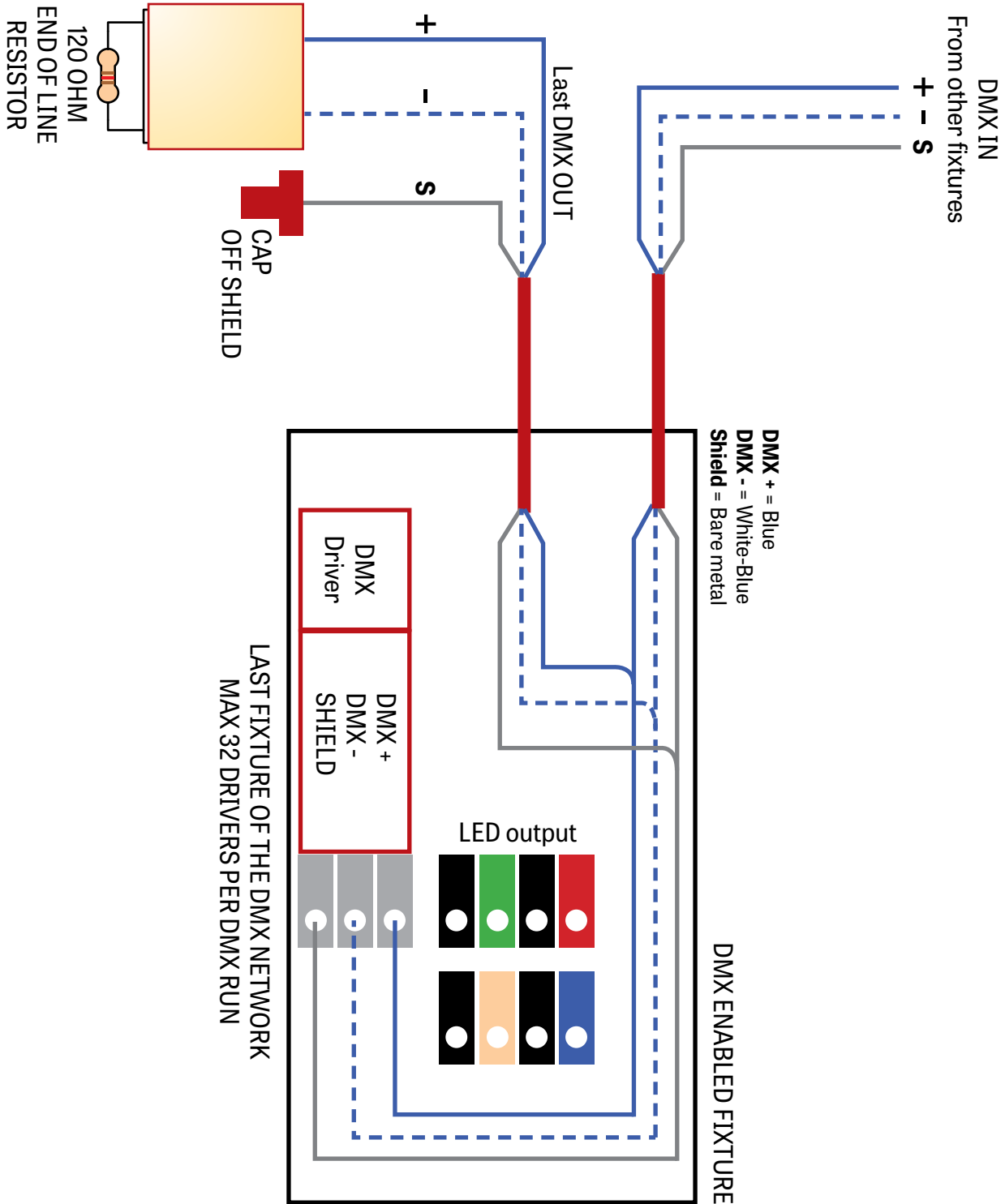

DUO 1-4 ZONE

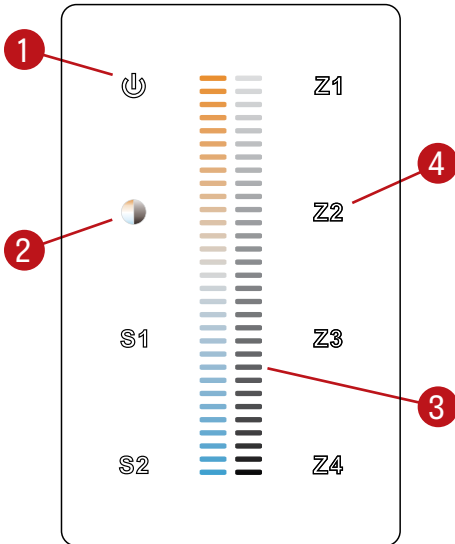

- (1) Power: Use this button to turn ON or OFF the fixture.
- (2) Brightness/CCT: Use the color/brightness toggle button to choose between color/brightness. When Blue: brightness is selected, when Yellow: color is selected.
- (3) Slider: Depending on the mode chosen in step 2, the slider will allow the user to set desired color or brightness.
- (4) Zone select: Up to 4 zones can be selected either independently or together. Once selected, the commands will be sent to the zone identified by a Blue LED.

Default DMX Addresses:

- 1 Warm
- 2 Cool

CAVA SQUARE LED

PENDANT DIRECT



CHROMAWERX TUNABLE WHITE AND DIM TO WARM

350 LUMEN AT 80CRI - LOW OUTPUT

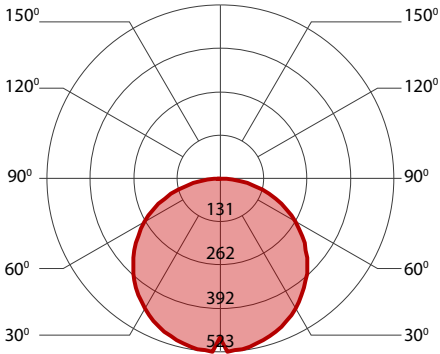

PERFORMANCE PER 4'

LED output	Color Temp	Watts	Nominal Delivered Lumens	Efficacy LPW
low output	2700K	12.5	1400	112
low output	3000K	12	1400	116
low output	3500K	12	1400	118
low output	4000K	11.5	1400	122
low output	6500K	11	1400	127

500 LUMEN AT 80CRI - MEDIUM OUTPUT

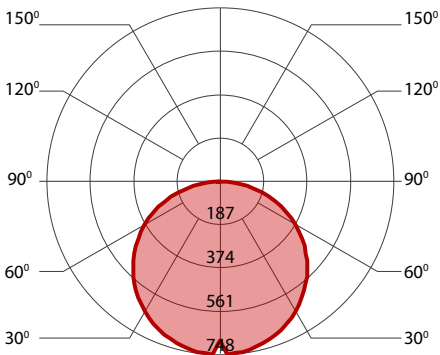

PERFORMANCE PER 4'

LED output	Color Temp	Watts	Nominal Delivered Lumens	Efficacy LPW
medium output	2700K	18.5	2000	109
medium output	3000K	17.5	2000	113
medium output	3500K	17.5	2000	115
medium output	4000K	17	2000	119
medium output	6500K	16	2000	124

750 LUMEN AT 80CRI - HIGH OUTPUT

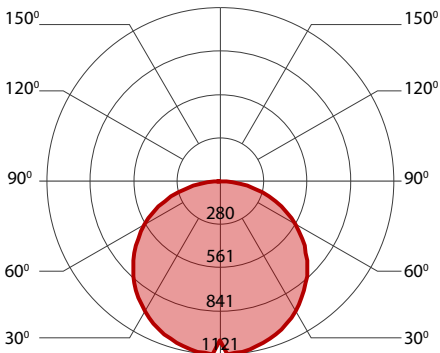

PERFORMANCE PER 4'

LED output	Color Temp	Watts	Nominal Delivered Lumens	Efficacy LPW
high output	2700K	27.5	3000	110
high output	3000K	26.5	3000	113
high output	3500K	26	3000	116
high output	4000K	25	3000	119
high output	6500K	24	3000	124