



 This product must be installed in accordance with the National Electrical Code and all applicable local codes, by a person familiar with the construction and operation of the product, and the hazards involved. Proper grounding is required for safety.

Ce produit doit être installé suivant le code national de l'électricité, ainsi que tous les codes locaux applicables, par une personne familière avec la construction et le fonctionnement du produit, ainsi que tous les risques qui y sont associés. La mise à terre électrique est obligatoire pour la sécurité.

 Wire dimming conductors as Class 1.

 For electrical connections, follow the wiring diagrams on page 3 according to specified drivers in product configuration.

1 REMOVE LENS.

Remove the lens [A] from the fixture [B] using the provided lens tool and keep in a safe place.

Note: Manipulate carefully as to not scratch paint or damage lens.

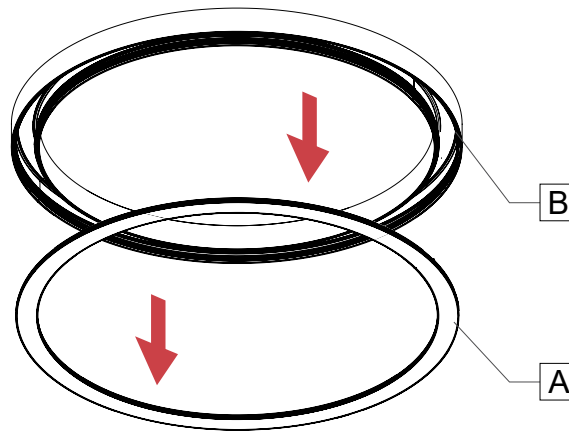
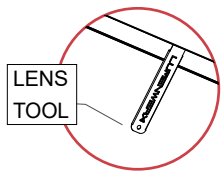

2 PREPARE THE INSTALLATION AREA.

Prepare the area where the fixture is going to be installed. Locate the mounting points and electrical connection points on the ceiling according to the dimensions and the client drawings.

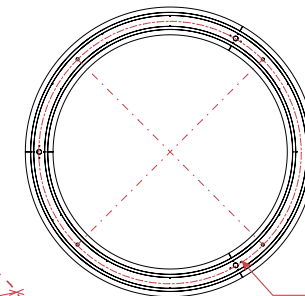
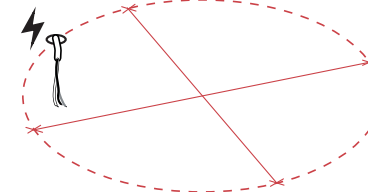

Center Line	Ø
24"	Ø 21-13/16"
36"	Ø 34-1/4"
48"	Ø 45-11/16"
60"	Ø 58-1/8"
72"	Ø 70-17/32"

 For remote driver box, please refer to the [remote driver installation sheet](#) for more information.

 Do not cover the light element lens or heatsink with any materials or adhesive tapes when the fixture is powered.

 Handle the LED cartridge carefully during removal and installation. Tools must not touch the LED chips. Contact may result in damage and LED failure.

3 MAKE ELECTRICAL CONNECTIONS.

Make electrical connections between remote driver [C] and fixture [B].

Note: Number of wires may vary.

Warning: A luminaire with more than one power supply connection means shall be connected to only one branch circuit.

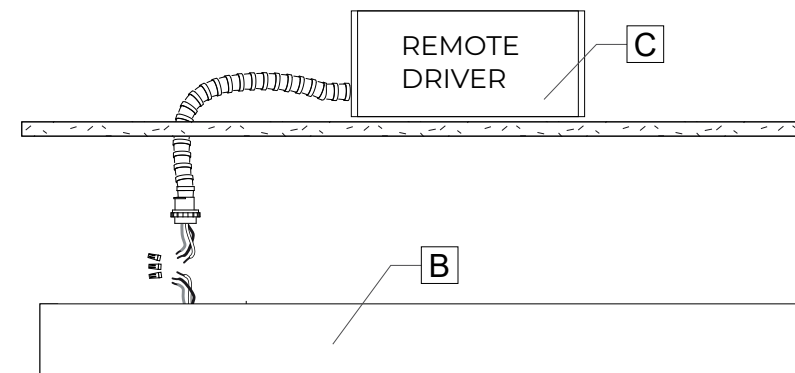

4 FASTEN FIXTURE.

Fasten fixture to 1/4" - 20 threaded studs [D] using washers [E] and nuts [F].

Note: If there is no threaded stud present, the fixture can be screwed directly onto the ceiling.

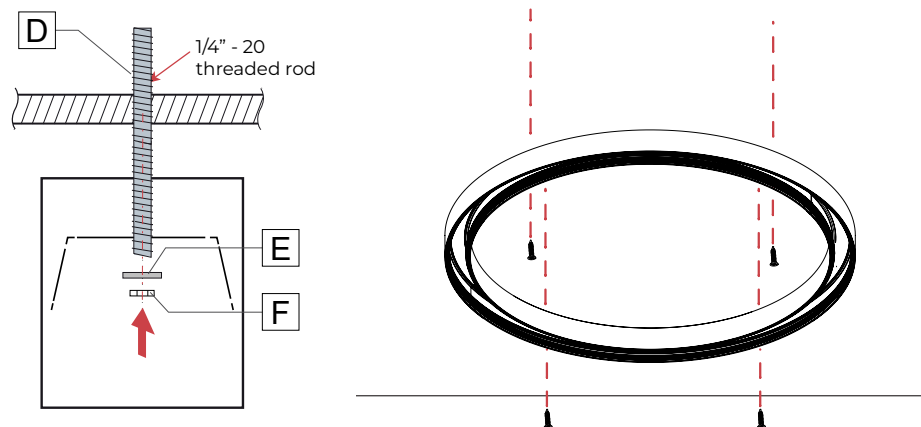

5 REINSTALL THE LENS.

Firmly snap lens [A] into place being careful not to push in too deep.

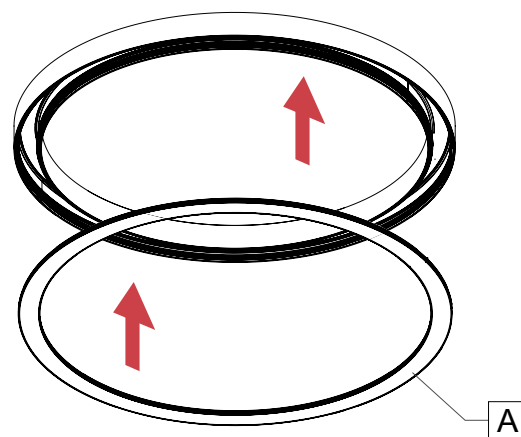

WIRING DIAGRAMS (1 Circuit)

For electrical connections, follow the wiring diagrams according to specified drivers in product configuration.

REMOTE DRIVER - STATIC WHITE

RED	LED (+)
BLUE	LED (-)

Note:

For remote driver wiring in the remote driver box (RDB), refer to the applicable driver wiring.

For max wire distance from driver, please check our website: WWW.LUMENWERX.COM

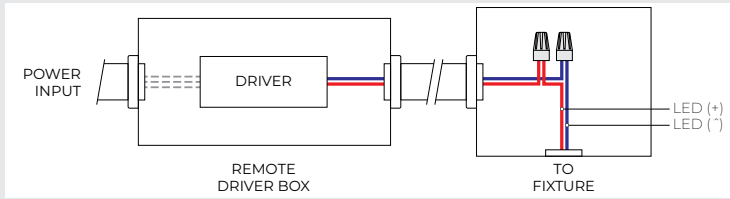

RD1 / RELD1 / RELO0

BLACK	HOT
WHITE	NEUTRAL
GREEN	GROUND
PURPLE	DIM (+) 0-10V
PINK or GRAY	DIM (-) 0-10V

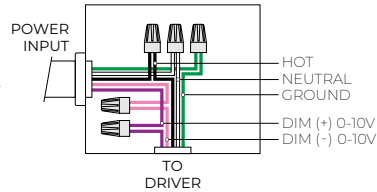

RDA

BLACK	HOT
WHITE	NEUTRAL
GREEN	GROUND
PURPLE	DALI (+)
PINK or GRAY	DALI (-)

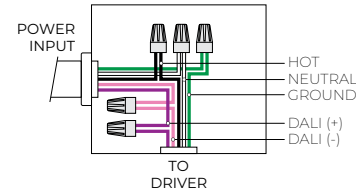

RLTEA2W

BLACK	HOT
WHITE	NEUTRAL
GREEN	GROUND

Note:
120V max input voltage

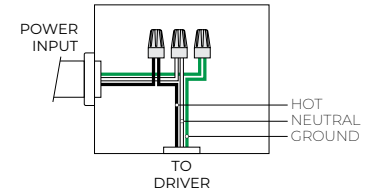

RLDE1

BLACK	HOT
WHITE	NEUTRAL
GREEN	GROUND
PURPLE	E1 TO ECOSYSTEM
PINK or GRAY	E2 DIGITAL LINK

