

CURVIA 4

PATTERN

PENDANT - RECESSED - SURFACE



Declare.

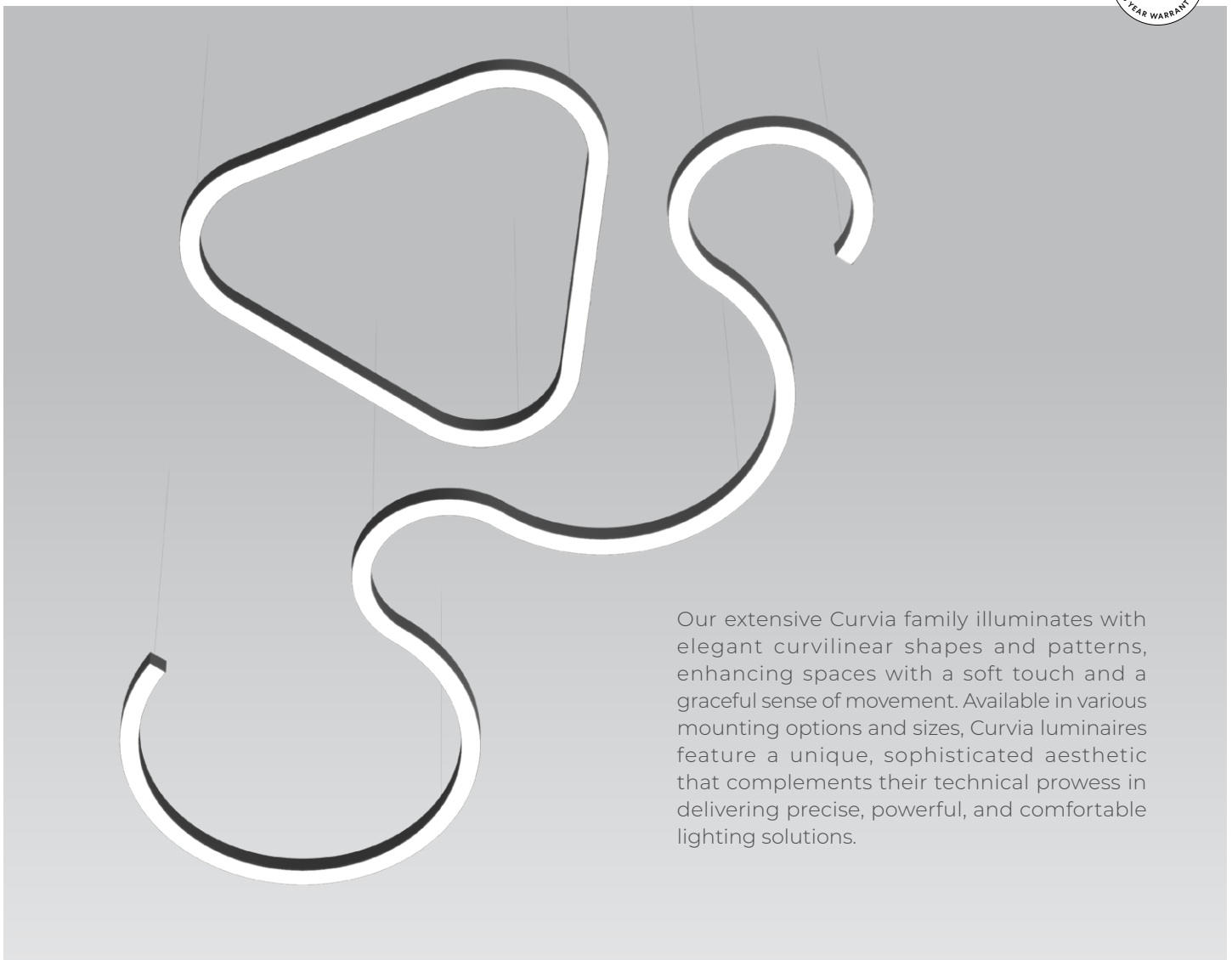

Our extensive Curvia family illuminates with elegant curvilinear shapes and patterns, enhancing spaces with a soft touch and a graceful sense of movement. Available in various mounting options and sizes, Curvia luminaires feature a unique, sophisticated aesthetic that complements their technical prowess in delivering precise, powerful, and comfortable lighting solutions.

Lens Positions

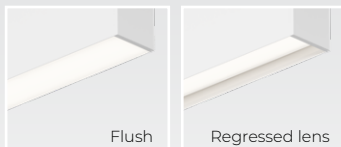

Module Options

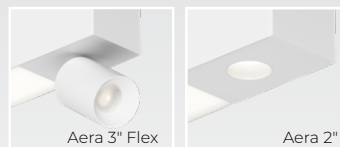

SENSORS
For latest information on sensors, click [here](#).



Curvia Additions Brochure

Curvia Family (Refer to other spec sheets)

Curvia Mini	Curvia Slim	Curvia Slim Seal	Curvia Prism	Curvia	Curvia XYZ	Curvia Horizon	Curvia Perimeter	Curvia Seal Perimeter	Curvia Seal	Curvia Acoustix
1"	1", 2"	1", 2"	2"	2", 3", 4"	2", 3"	2", 3"	2", 3", 4", 5"	2", 3", 4"	2", 3", 4"	2"
Ring	Ring Shapes Pattern	Ring Shapes Pattern	Ring Shapes Pattern	Ring Shapes Pattern	Pattern	Ring Shapes	Pattern	Pattern	Ring Shapes Pattern	Ring Shapes Pattern

3737 Cote Vertu St-Laurent, Quebec, Canada H4R 2C9
T (514) 225-4304 F (514) 931-4862
www.lumenwerx.com



Lumenwerx reserves the right to modify product specifications without notification.
© Lumenwerx, ULC. All rights reserved.
CURVIA4-PATTERN-SPEC-REV6 March 24, 2026

CURVIA 4

PATTERN

PENDANT - RECESSED - SURFACE







Project: _____

Type: _____

Order Guide

▶ A drawing of your pattern is required - anything from a line drawing to an architectural drawing.

LUMINAIRE ID	DISTRIBUTION	DIRECT OPTIC	LENS POSITION	INDIRECT OPTIC <small>Specify NA for Direct fixture</small>	LIGHT SOURCE ⁵	CRI			
CURV4PPAT - Curvia 4" Pendant Pattern CURV4RPAT - Curvia 4" Recessed Pattern CURV4SPAT - Curvia 4" Surface Pattern	DI ¹ - Direct/Indirect D - Direct ¹ Only available for pendant mounting.	HLO - High-Efficiency Lambertian Optic AOO ² - Asymmetric Opal Optic BLA ³ - Blank ² Direction of light must be indicated on RCP/lighting plans. ³ Specify when only modules are required.	FH - Flush RG ⁴ - Regressed ⁴ Only available with HLO.	HLO - High-Efficiency Lambertian Optic NA - Not applicable	SW - Static white FS - Full spectrum static white ⁵ Chromawerx SOLA, DUO, and QUADRO also available. Consult factory.	80CRI ⁶ - 80+ CRI 90CRI ⁶ - 90+ CRI 95CRI ⁷ - 95+ CRI ⁶ Not available with full spectrum. ⁷ Not available with static white.			
DIRECT LUMEN PACKAGE		INDIRECT LUMEN PACKAGE <small>Specify NA for Direct fixture</small>	COLOR TEMP.	TOTAL PATTERN LENGTH	CORNER TYPE ^{10, 11}				
350LMF - Eco low output 350 lm/ft 500LMF - Low output 500 lm/ft 750LMF - Medium output 750 lm/ft 1000LMF ⁸ - High output 1000 lm/ft 1200LMF ⁸ - Ultra high output 1200 lm/ft NA - Not applicable ⁸ Not available with full spectrum.		350LMF - Eco low output 350 lm/ft 500LMF - Low output 500 lm/ft 750LMF - Medium output 750 lm/ft 1000LMF ⁹ - High output 1000 lm/ft NA - Not applicable ⁹ Not available with full spectrum.	27K - 2700K 30K - 3000K 35K - 3500K 40K - 4000K 50K - 5000K	#FT#IN - Specify total pattern length (#) in 1' and/or 1" increments	CURVED CORNER ^{12, 13} #LEVC - Curved leveled corner  NA - None ¹⁰ See page 4 for details. ¹¹ If more than one option is specified, separate codes with a "+", e.g. 2LEVC+1LEVS(A45). ¹² Minimum radius is 8". Consult factory for smaller radii. ¹³ Specify quantity (#), e.g. 2LEVC. ¹⁴ Specify quantity (#) and angle (A##), e.g. 2LEVS(A90).	STRAIGHT CORNER ¹⁴ #LEVS(A##) - Straight leveled corner  ¹⁴ Specify quantity (#) and angle (A##), e.g. 2LEVS(A90).			
INTERSECTION TYPE ^{15, 16, 17, 18}			VOLTAGE	DRIVER ²¹	ELECTRICAL				
CURVED INTERSECTION #TCI - Soft T curved intersection #XCI - Soft X curved intersection #YCI - Soft Y curved intersection #CCI - Soft C curved intersection  CU ¹⁹ - Custom NA - None ¹⁵ See page 4 for details. ¹⁶ If more than one option is specified, separate codes with a "+", e.g. 1TCI+2TSI. ¹⁷ Specify quantity (#) for each required intersection type. ¹⁸ Not available with AOO. ¹⁹ Provide a drawing for custom intersections.		STRAIGHT INTERSECTION #TSI - Sharp T straight intersection #XSI - Sharp X straight intersection #YSI - Sharp Y straight intersection  ²⁰ Only available with DI driver. Subject to factory evaluation.		120V - 120V 277V - 277V UNV - 120V-277V 347V ²⁰ - 347V ²⁰ Only available with DI driver. Subject to factory evaluation.	D1 - 1% 0-10V ELV ²² - ELV 120V TRI ²² - TRIAC 120V DA ²³ - DALI LDEI ²³ - Lutron Hi-Lume 1% Eco ELD1 - eldoLED 1% ECOdrive 0-10V ELD0 - eldoLED 0.1% SOLOdrive 0-10V ²¹ Integral or remote subject to factory evaluation. Code will be updated with prefix "R" if factory determines driver to be remote. ²² Only available with 120V. ²³ On-site commissioning is required.	1C - 1 circuit 2C ²⁴ - 2 circuits #MC ²⁵ - Multi circuit EC - Emergency-powered fixture ²⁴ Only available for Direct/Indirect. Separate direct and indirect circuits. ²⁵ Specify total number of circuits (#), including any required for electrical section options. Provide drawing or layout specifications. Minimum 4" section per circuit for integral drivers. ²⁶ Integral or remote subject to factory evaluation. GTD must be housed with the driver. ²⁷ Not available with 347V. ²⁸ Minimum 12" radius for integral GTD.	NL - Night light fixture DL - Daylight fixture GTD ^{26, 27, 28} - Generator transfer device fixture		
ELECTRICAL SECTIONS (optional) ^{29, 30}			MOUNTING ³⁷	FINISH	OPTIONS ³⁹	MODULE (optional) ⁴²			
#EC## ³¹ - Emergency-powered section #NL## ³¹ - Night light section #DL## ³¹ - Daylight section #GTD## ^{31, 32, 33, 34} - Generator transfer device section ²⁹ Specify with multi circuit (#MC) electrical option only. ³⁰ Provide drawing or layout specifications. Consult factory for other configurations. Default section length is 4'. ³¹ Specify quantity (#), and section length in inches (##). ³² Integral or remote subject to factory evaluation. GTD/EMB must be housed with the driver. ³³ Not available with 347V. ³⁴ Minimum 12" radius for integral GTD. ³⁵ Specify quantity (#). Each battery powers a 4' linear section. Minimum length of linear section is 5' for Direct and 8' for Direct/Indirect. ³⁶ All batteries will be on the same circuit and power the direct LEDs.			#EMB ^{32, 33, 35, 36} - Emergency battery NA - None	PENDANT ³⁸ ACS - Aircraft cable, standard STS - Stem, standard ACC() - Aircraft cable, custom STC() - Stem, custom ³⁷ The mounting options selected must reflect the luminaire ID. ³⁸ Standard canopies are black for black fixtures, and white for all other finishes. See page 3 for full details on standard and custom options.	RECESSED DTR - Trim DMF - Drywall mud flange	SURFACE DRC - Drywall ceiling	W - Matte white AL - Aluminum B - Matte black CF# - Custom finish, specify RAL# ³⁹ Separate codes with a "+" if more than one is specified. ⁴⁰ Only available with pendant mounting aircraft cable option. ⁴¹ Only available with recessed mounting.	FU120 - Fuse 120V FU277 - Fuse 277V CTB9 ⁴⁰ - T-bar caddy clip, 9/16" CTB15 ⁴⁰ - T-bar caddy clip, 15/16" CTG9 ⁴⁰ - Tegular caddy clip, 9/16" ⁴² See page 3 for ordering details. <ul style="list-style-type: none"> • Only available with static white. • Only available with flush lens. • Not available with EMB. ⁴³ Only available with stem when specified with pendant mounting.	#AE3FCY() ⁴³ - Aera 3" #AE2R() - Aera 2" NA - None



CURVIA 4

PATTERN

PENDANT - RECESSED - SURFACE



Module Code

- For a module, specify the options in the parentheses.
- The light source is static white.
- CRI of module matches specification of main fixture.
- Minimum 4' fixture and minimum 2' section per module. Consult factory for other configurations.

Example: 1AE3FXCY(4.5IN-FTMB-BVL-FTMB-SDL-15DEG-27K-NA-10W)

MODULE ^{1,2}	HEIGHT	CYLINDER FINISH	BAFFLE	BAFFLE FINISH	LENS AT BAFFLE	BEAM ANGLE	COLOR TEMP.	ACCESSORIES AT LIGHT ELEMENT ^{4,5}	WATTAGE
#AE3FXCY() - Aera 3" Flex Cylinder ¹ Specify quantity (#). ² 6" blank per module. Blank finish will match fixture finish.	4.5IN - 4.5"	FTMB - Matte black FTMW - Matte white FCHP - Champagne FDBZ - Dark bronze CF# - Custom finish, specify RAL #	BVL - Bevel PHL - Pinhole BVLD - Decorative bevel	FTMB - Matte black FTMW - Matte white FSPC - Satin silver FSSPC - Matte silver FCHP - Champagne FDBZ - Dark bronze CF# - Custom finish, specify RAL #	SDL ³ - Soft diffused lens, Solite FDL ³ - Frosted diffused lens CL ³ - Clear lens NOL - No lens ³ Not available with LSDL/LFDL accessories.	15DEG - 15° Narrow spot 25DEG - 25° Spot 35DEG - 35° Narrow flood 50DEG - 50° Wide flood	27K - 2700K 30K - 3000K 35K - 3500K 40K - 4000K 50K - 5000K	LSDL - Soft diffused lens, Solite LFDL - Frosted diffused lens LS - Linear spread HEX - Hex louver NA - None ⁴ Choose up to 2 options. Separate codes with a "+" if more than one is specified, e.g. LSDL+LS. ⁵ LSDL and LFDL cannot be combined. LS and HEX cannot be combined.	10W - 10 W output, up to 1132 lm 14W - 14 W output, up to 1545 lm

Example: 1AE2R(7W-10DEG-27K-SDL-FTMB)

MODULE ^{1,2,3}	WATTAGE	BEAM ANGLE	COLOR TEMP.	LENS AT BAFFLE	BAFFLE FINISH
#AE2R() - Aera 2" Round Downlight ¹ Specify quantity (#). ² 6" blank per module. Blank finish will match fixture finish. ³ Module is trimless.	7W - 7 W output, up to 714 lm 10W - 10 W output, up to 961 lm	10DEG - 10° very narrow spot 15DEG - 15° Narrow spot 25DEG - 25° Spot 35DEG - 35° Narrow flood 50DEG - 50° Wide flood	27K - 2700K 30K - 3000K 35K - 3500K 40K - 4000K 50K - 5000K	SDL - Soft diffused lens, solite FDL - Frosted diffused lens CL - Clear lens	FTMB - Matte black FTMW - Matte white FSPC - Satin silver FSSPC - Matte silver FCHP - Champagne FDBZ - Dark bronze CF# - Custom finish, specify RAL#

Pendant Mounting Code

Aircraft Cable

Standard

ACS - Aircraft cable, standard

- Ø 5" for power canopy
- Ø 3" for non-power canopy
- Canopies are black for black fixtures, and white for all other fixture finishes
- Power cord is black for black fixtures, and white for all other fixture finishes
- Aircraft cable length is 36"

Stem

Standard

STS - Stem, standard

- Ø 5" for power canopy
- Ø 5" for non-power canopy
- Canopies are black for black fixtures, and white for all other fixture finishes
- Stem finish is the same color as fixture
- Stem length is 18"
- Stem is not field adjustable

Custom

ACC() - Aircraft cable, custom

NON-POWER CANOPY SIZE	AIRCRAFT CABLE LENGTH	CANOPY FINISH	POWER CORD COLOR	OPTION
3NPC - Ø 3" non-power canopy 5NPC - Ø 5" non-power canopy	36IN - 36" 72IN - 72" 120IN - 120" #IN ¹ - Other lengths, specify in inches ¹ Maximum length is 288". For longer lengths, please consult factory.	W - Matte white AL - Aluminum B - Matte black CF# - Custom finish, specify RAL#	PCW - White PCB - Black	SEM ² - Seismic mounting SLC ² - Sloped ceiling for aircraft cable NA - None ² Not available with the Ø 3" non-power canopy size.

Example: ACC(3NPC-72IN-W-PCB-NA)

Custom

STC() - Stem, custom

NON-POWER CANOPY SIZE	STEM LENGTH	CANOPY FINISH	STEM COLOR	OPTION
5NPC - Ø 5" non-power canopy	18IN - 18" 36IN - 36" #IN ³ - Specify length in inches ³ Minimum length is 6". Maximum length is 72". Stem is not field adjustable.	W - Matte white AL - Aluminum B - Matte black CF# - Custom finish, specify RAL#	STW - Matte white STAL - Aluminum STB - Matte black STCF# - Custom finish, specify RAL#	SLS - Sloped ceiling for stem NA - None

Example: STC(5NPC-36IN-W-STW-SLS)

CURVIA 4

PATTERN

PENDANT - RECESSED - SURFACE



CURVED CORNERS

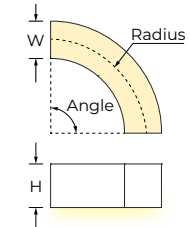

STRAIGHT CORNERS

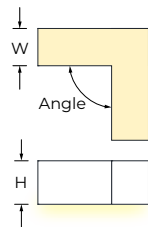

	DIRECT	DIRECT/INDIRECT
Height (H)	3 1/2"	4"
Width (W)	4"	

CURVED INTERSECTIONS

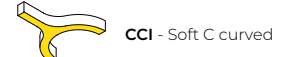
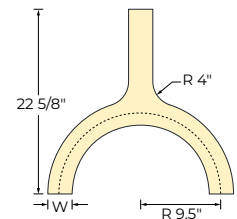
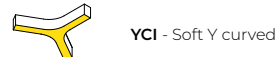
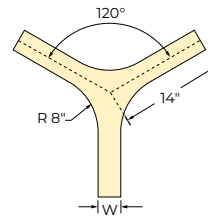
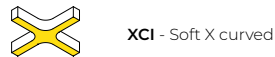
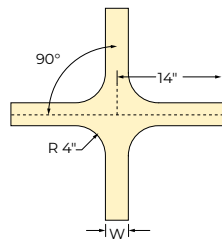
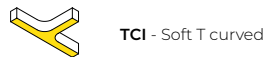
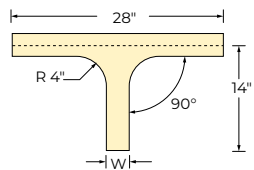

STRAIGHT INTERSECTIONS

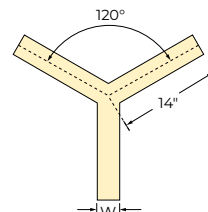
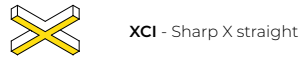
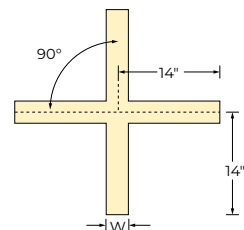
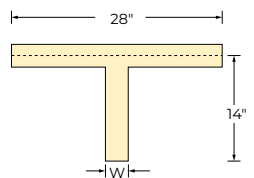

CURVIA 4

PATTERN

PENDANT - RECESSED - SURFACE



Dimensions

PENDANT

DIRECT/INDIRECT

Flush Lens

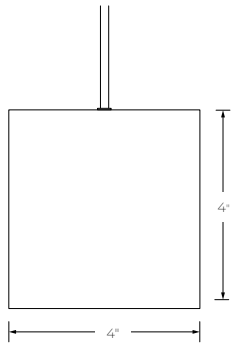

Regressed Lens

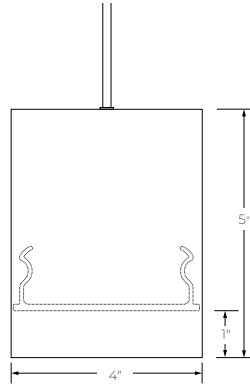

DIRECT

Flush Lens

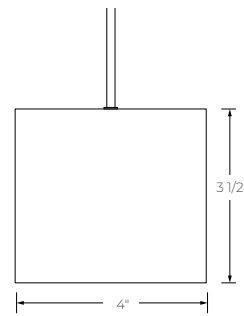

Regressed Lens

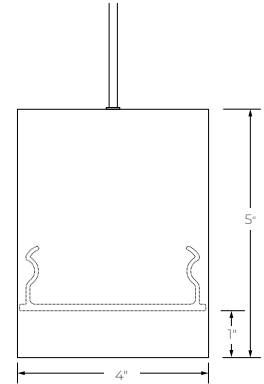

SURFACE

Flush Lens

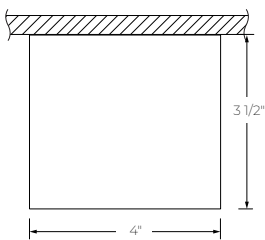

Regressed Lens

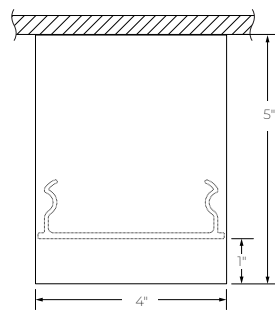

CURVIA 4

PATTERN

PENDANT - RECESSED - SURFACE



RECESSED

DTR - Trim

Flush Lens

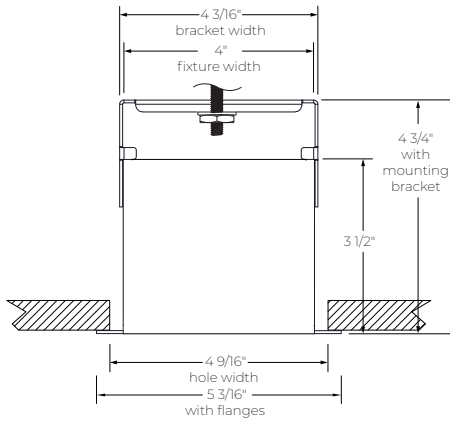

Regressed Lens

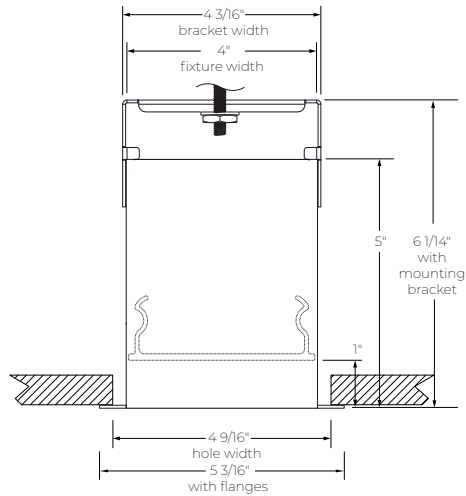

DMF - Drywall mud flange

Flush Lens

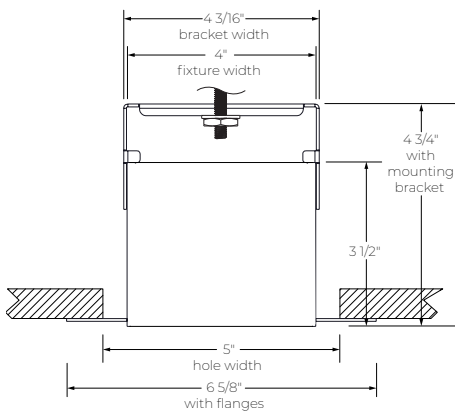

Regressed Lens

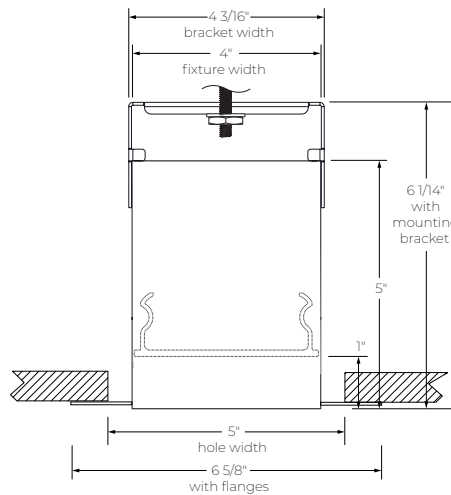

CURVIA 4

PATTERN

PENDANT - RECESSED - SURFACE



Photometrics

Values calculated based on 4' straight segments at 3500K for all optics.

DIRECT OPTICS

INDIRECT OPTIC

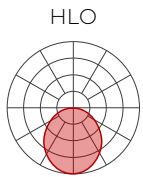

LM/FT	W/FT	LM/W
350	2.7	132
500	3.9	129
750	6	126
1000	8.2	122
1200	10	119

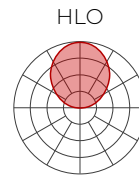

LM/FT	W/FT	LM/W
350	2.4	149
500	3.5	145
750	5.4	139
1000	7.4	134

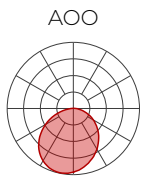

LM/FT	W/FT	LM/W
350	3.1	112
500	4.6	110
750	7.0	107
1000	9.6	104
1200	11.9	101

MULTIPLIER TABLES

Use these tables to get results for different color temperatures and lens positions for all photometric tables.

Multiplier - CCT

CCT	WATTS		LPW	
	80+ CRI / 90+ CRI	80+ CRI / 90+ CRI	80+ CRI / 90+ CRI	80+ CRI / 90+ CRI
2700K	1.05		0.95	
3000K	1.02		0.98	
3500K	1.00		1.00	
4000K	1.00		1.00	
5000K	0.96		1.04	

Multiplier - Lens position

DIRECT LENS	WATTS	LPW
Flush lens	1.00	1.00
Regressed lens	0.98	1.02

DIRECT/INDIRECT - LPW CALCULATION

For Direct/Indirect performance values, follow the formula.

$$\left(\frac{\text{DIRECT LM/FT} + \text{INDIRECT LM/FT}}{\text{DIRECT W/FT} + \text{INDIRECT W/FT}} \right) = \text{LPW}$$

CURVIA 4

PATTERN

PENDANT - RECESSED - SURFACE



AERA 3" FLEX MODULE

Values calculated based on 3500K and SDL lens option.

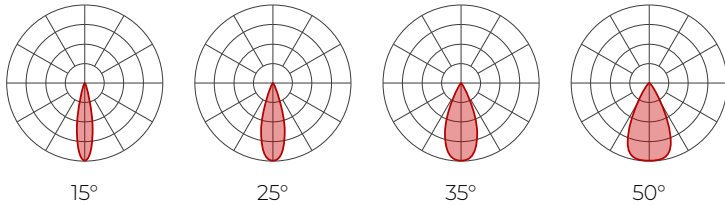

Delivered lumens (LM)

CRI	80+ CRI				90+ CRI			
	15°	25°	35°	50°	15°	25°	35°	50°
BEAM								
10 W	1056	1127	1132	1003	987	1053	1058	937
14 W	1441	1539	1545	1370	1347	1438	1444	1280

Efficacy (LM/W)

CRI	80+ CRI				90+ CRI			
	15°	25°	35°	50°	15°	25°	35°	50°
BEAM								
10 W	106	113	113	100	99	105	106	94
14 W	103	110	110	98	96	103	103	91

Please follow the multiplier tables to ensure correct lumen value.

CCT	
2700K	0.94
3000K	0.98
3500K	1
4000K	1.05
5000K	1.05

BAFFLE	
Bevel	1
Pinhole	0.92
Decorative bevel	1

LENS AT BAFFLE *	
SDL - Soft diffused lens, Solite	1
FDL - Frosted diffused lens	0.8
CL - Clear lens	1.1
NOL - No lens	1.1

ACCESSORIES AT LIGHT ELEMENT *	
LSDL - Soft diffused lens, Solite	1
LFDL - Frosted diffused lens	0.8
LS - Linear spread	0.84
HEX - Hex louver	0.86

* When more than one lens or accessory is specified, multiply together the value of each lens and/or accessory. e.g. NOL + LSDL + LS = 1.1 x 1 x 0.84 = 0.924

AERA 2" MODULE

Values calculated based on 3500K and SDL lens option.

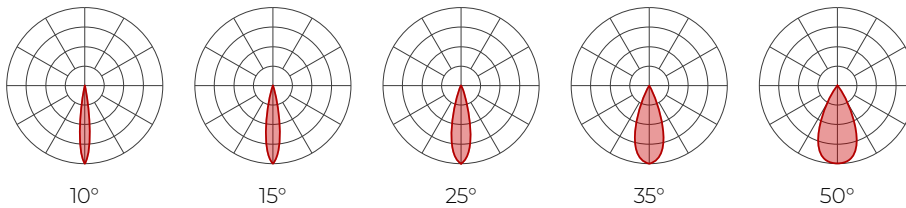

Delivered lumens (LM)

CRI	80+ CRI					90+ CRI				
	10°	15°	25°	35°	50°	10°	15°	25°	35°	50°
BEAM										
7 W	589	654	714	705	676	550	611	667	659	632
10 W	792	880	961	949	910	740	822	898	887	850

Efficacy (LM/W)

CRI	80+ CRI					90+ CRI				
	10°	15°	25°	35°	50°	10°	15°	25°	35°	50°
BEAM										
7 W	84	93	102	101	97	79	87	95	94	90
10 W	79	88	96	95	91	74	82	90	89	85

Please follow the multiplier tables to ensure correct lumen value.

CCT	
2700K	0.94
3000K	0.98
3500K	1
4000K	1.05
5000K	1.05

LENS AT BAFFLE	
SDL - Soft diffused lens, Solite	1
FDL - Frosted lens	0.8
CL - Clear lens	1.1



CURVIA 4

PATTERN

PENDANT - RECESSED - SURFACE



Technical Specifications

OPTICS

High-Efficiency Lambertian Optic (HLO)

Lumenwerx's High-Efficiency Lambertian Optic is engineered with reflective sidewalls that distribute LED output across acrylic shielding. To negotiate the curves of Lumenwerx rounded fixtures, the HLO is equipped with proprietary SupremeGrip™ technology, which keeps the optic securely in place.

Asymmetric Opal Optic (AOO)

The Asymmetric Opal Optic (AOO) provides targeted illumination while diffusing light evenly, minimizing glare and spill. Its design creates a soft, inviting ambiance, making it ideal for architectural and accent lighting in modern spaces.

LIGHT SOURCE

Static white

Custom array of mid-flux LEDs are cartridge-mounted with quick-connect wiring to facilitate service and thermal management. Available in 2700K, 3000K, 3500K, 4000K, and 5000K with a minimum 80+ CRI and an option for 90+ CRI with elevated R9 value. Color consistency maintained to within 3 SDCM. LEDs operate at reduced drive current to optimize efficacy and lumen maintenance. All LEDs have been tested in accordance with IESNA LM-80-08 and the results have shown L80 lumen maintenance greater than 60,000 hours. Absolute product photometry is measured and presented in accordance with IESNA LM-79, unless otherwise indicated.

Full spectrum static white

The full spectrum LED option offers improved color particularly in the cyan region that is beneficial in both healthcare and circadian lighting strategies. The cyan region in full spectrum LED is richer at the 480 nm range.

ELECTRICAL

Factory-set, adjustable output current LED driver with universal (120-277 VAC) input. Dimmable from 100% to 1% with 0-10V dimming control. Rated life (90% survivorship) of 50,000 hours at 50°C max. ambient (and 70°C max. case) temperature. At maximum driver load: Efficiency > 84%, PF > 0.9, THD < 20%. Other specifiable options include Lutron Hi-Lume 1% Eco, eldoLED 1% ECOdrive 0-10V, eldoLED 0.1% SOLOdrive 0-10V, ELV, TRIAC, and DALI protocol drivers. All of our standard 0-10V drivers are NEMA 410 compliant. ELV and TRIAC dimming performance (including minimum dimming percentage) subject to dimmer selection.

PoE

Depending on the PoE manufacturer selected, Lumenwerx will install the node in factory as either integral to the luminaire or as a remote module. Factory programming of the PoE node may or may not enable the following functionalities: lumen package, DUO (tunable white), QUADRO (RGBW), emergency battery backup, and sensor integration. These must be addressed and evaluated on a case-by-case basis.

Battery

Factory installed long life, high temperature, maintenance-free Lithium-Ion battery pack with self-test functionality, test switch and charge indicator. Minimum of 90 minutes operation, up to 1000 lumens per 4' (25°C) emergency lighting output and recharge time of 24 hours.

MOUNTING

Pendant: Pendant fixtures can be mounted either with aircraft cable or with stem.

Recessed: Recessed fixtures can be mounted in drywall ceilings with trim or mud flange options.

Surface: Surface fixtures can be mounted directly to drywall and hard surface ceilings, hardware supplied by others. A minimum of 6" from the vertical wall is required.

FINISH

Interior: 95%, reflective matte powder coated white paint.

Exterior: Matte white, matte black or aluminum powder coating. Custom finishes are also available.

AERA FLEX MODULE

Aera Flex is a round spotlight that rotates 355° and tilts 90°, available in four beam angles of 15°, 25°, 35°, and 50°. LED light source CCT options are 2700K, 3000K, 3500K, 4000K, and 5000K available in either 80+ CRI or 90+ CRI. Offered in 4.5" height with three baffle options: bevel, pinhole, and decorative bevel. Aera Flex is available in a wide range of colors.

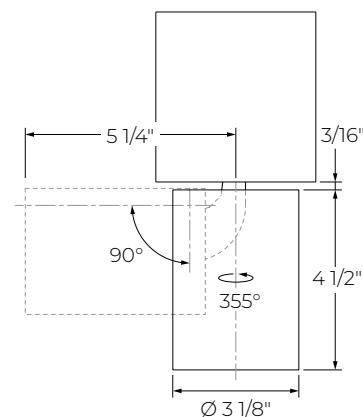

Aera 3" Flex

CURVIA 4

PATTERN

PENDANT - RECESSED - SURFACE



AERA MODULE

Aera Downlight is available in five beam angles of 10°, 15°, 25°, 35°, and 50°. LED light source CCT options are 2700K, 3000K, 3500K, 4000K, and 5000K available in either 80+ CRI or 90+ CRI. Aera Downlight is available in a wide range of colors.

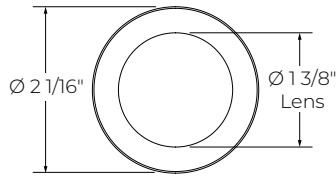

Aera 2"

CONSTRUCTION

Housing: Extruded aluminum and aluminum sheet, up to 90% recycled content

Reflectors: Aluminum

Lens: Acrylic

Hanger: Chromed griplock securely attached in end caps and/or joiners with stainless steel hardware

Aircraft cable suspension: \varnothing 1/16" stainless steel aircraft cable

Stem: \varnothing 1/2" threaded steel tube

WEIGHT

Pendant Direct: 2.5 lb/ft - 1.13 kg/ft

Pendant Direct/Indirect: 3.2 lb/ft - 1.45 kg/ft

Recessed: 3.2 lb/ft - 1.45 kg/ft

Surface: 2.5 lb/ft - 1.13 kg/ft

CERTIFICATIONS

ETL: Rated for indoor dry/damp locations. Conforms to UL Standard 1598 and certified to CAN/CSA Standard C22.2 No. 250.0.

IC rated: Suitable for direct contact with insulation. For Recessed mounting only.

Declare: [LBC Red List Approved](#)

WARRANTY

Lumenwerx provides a five-year limited warranty on electrical and mechanical performance of the luminaires, including the LED boards, drivers, and auxiliary electronics. Lumenwerx will repair or replace defective luminaires or components at our discretion, provided they have been installed and operated in accordance with our specifications. Other limitations apply, please refer to the full warranty on our website.