

ECANA 6" DOWNLIGHT

SQUARE RECESSED WALL WASH



Declare.

Trimless

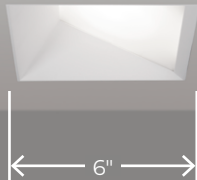

Flanged Trim



The Ecana downlight family is designed as round or square fixtures with simple detailing, available in 3", 4", and 6" sizes. The family includes fixed, adjustable, and wall wash configurations and blends effortlessly into various settings, enriching small and large-scale projects with practical, cost-effective, and finely tuned lighting.

Beam Angles



Low UGR < 10

Wall Wash

Performance

LUMEN OUTPUT ¹	WATTS	EFFICACY
1136 lm	20 W	57 lm/W
1525 lm	28 W	54 lm/W
2413 lm	40 W	60 lm/W
2818 lm	48 W	59 lm/W

¹ Lumen packages are assuming 3500K, 80 CRI.

Plenum Clearance



Light Source

Static White
SOLA - Dim-to-Warm
DUO - Tunable White



Ceiling Types



Ecana Family (Refer to other spec sheets)



3" / 4" / 6"
Round / Square
Recessed Adjustable



3" / 4" / 6"
Round / Square
Recessed



3" / 4" / 6"
Round / Square
Recessed Wall Wash



ECANA 6" DOWNLIGHT

SQUARE RECESSED WALL WASH



Project: _____

Type: _____

Order Guide

1 - Housing (Example: EC6SRWW-TRM-SW-OF-ASB-120V-20W-D1)

LUMINAIRE ID ¹		TRIM STYLE	LIGHT SOURCE	INSTALLATION TYPE	MOUNTING OPTION ⁴
EC6SRWW					
EC6SRWW - Ecana 6" Square Recessed Wall Wash ¹ Recessed (fixed) and Recessed Adjustable also available. Consult other spec sheets.		TRM - Flanged trim TLMP - Trimless drywall mudplate TLMW ² - Trimless millwork	SW - Static white SOLA - Dim-to-warm single channel control DUO - Tunable white 2-channel control	OF - Open Frame Type Non-IC IC ³ - Type-IC RM - Remodel Type Non-IC CP ³ - Chicago Plenum Type-IC (CCEA) AT ³ - Airtight Type-IC ³ See Wattage section for limitations.	ASB ⁵ - Adjustable standard bar hangers FMB ⁵ - Flush mount bars ACB ⁵ - Adjustable commercial bar hangers AHC ⁵ - Adjustable hat channel bars NA - None ⁴ See page 4 for more details. ⁵ Not available with RM installation type.
VOLTAGE	WATTAGE	DIMMING ¹⁰			
120V - 120V 277V - 277V UNV - 120V-277V 347V ⁶ - 347V ⁶ Available with RD1 driver only. Please consult factory.	20W - 20 W output, up to 1136 lm 28W ⁷ - 28 W output, up to 1525 lm 40W ⁸ - 40 W output, up to 2413 lm 48W ^{8,9} - 48 W output, up to 2818 lm ⁷ Not available with 95 CRI when specified with IC/CP/AT. ⁸ Not available with IC/CP/AT. ⁹ Not available with 95 CRI when specified with RM.	INTEGRAL DI - 1% 0-10V ELV ¹¹ - ELV 120V TRI ¹¹ - TRIAC 120V LDE1 ^{12,13} - Lutron Hi-lume 1% Eco DA ^{12,13} - DALI ELD1 ¹² - eldoLED 1% ECOdrive 0-10V ELDO ¹² - eldoLED 0.1% SOLOdrive 0-10V PEQO ^{12,13,14} - Lutron Hi-lume Premier 0.1% EcoSystem DEB ¹⁵ - 0-10V with onboard emergency battery backup ¹⁰ PoE (Power-over-Ethernet) compatible. Consult factory for details. ¹¹ Available with 120V only. ¹² Not available with RM installation type. ¹³ On-site commissioning is required. ¹⁴ Available with 20 W output only. ¹⁵ Available with OF housing only.		REMOTE ¹⁶ RD1 - 1% 0-10V RELV ¹⁷ - ELV 120V RTRI ¹⁷ - TRIAC 120V RLDE1 ¹⁸ - Lutron Hi-lume 1% Eco RDA ¹⁸ - DALI RELD1 - eldoLED 1% ECOdrive 0-10V RELD0 - eldoLED 0.1% SOLOdrive 0-10V RPEQO ^{18,19} - Lutron Hi-lume Premier 0.1% EcoSystem +EB ²⁰ - Emergency battery ¹⁶ A remote driver box is provided, see page 3 for details. ¹⁷ Available with 120V only. ¹⁸ On-site commissioning is required. ¹⁹ Available with 20 W output only. ²⁰ For emergency battery, code will be like the following example: RD1+EB	
	SOLA ⁸ 28W - 28 W output, up to 1615 lm DUO ⁹ 28W - 28 W output, up to 1650 lm	SOLA SDI - Single 0-10V input SELV ¹¹ - ELV 120V STRI ¹¹ - TRIAC 120V	DUO DMX ¹³ - DMX DDA ¹³ - DALI DT6 DDA8 ¹³ - DALI DT8 DD1 - Dual 0-10V input for CCT/intensity LD2 ¹³ - Lutron DALI-2 digital	SOLA RSDI - Single 0-10V input RSELV ¹⁷ - ELV 120V RSTRI ¹⁷ - TRIAC 120V	DUO RDMX ¹⁸ - DMX RDDA ¹⁸ - DALI DT6 RDDA8 ¹⁸ - DALI DT8 RDD1 - Dual 0-10V input for CCT/intensity RLD2 ¹⁸ - Lutron DALI-2 digital +EB ²⁰ - Emergency battery

2 - Light & Baffle (Example: EC6SRWWB-SW-20W-WW-2STP-90CRI-27K-TRM-WW-FTMW-FTMW)

LUMINAIRE ID	LIGHT SOURCE	WATTAGE	BEAM	COLOR QUALITY	CRI	COLOR TEMP.
EC6SRWWB			WW			
EC6SRWWB - Ecana 6" Square Recessed Wall Wash	SW - Static white	20W - 20 W output, up to 1136 lm 28W ²¹ - 28 W output, up to 1525 lm 40W ²² - 40 W output, up to 2413 lm 48W ^{22,23} - 48 W output, up to 2818 lm ²¹ Not available with 95 CRI when specified with IC/CP/AT. ²² Not available with IC/CP/AT. ²³ Not available with 95 CRI when specified with RM.	WW - Wall wash	2STP - 2 Step MacAdam Ellipse 3STP - 3 Step MacAdam Ellipse	90CRI - 90 CRI 95CRI - 95 CRI 80CRI - 80 CRI	24K ²⁴ - 2400K 27K - 2700K 30K - 3000K 35K - 3500K 40K - 4000K 50K ²⁴ - 5000K ²⁴ Not available with 95 CRI.
	SOLA - Dim-to-warm single channel control DUO - Tunable white 2-channel control	SOLA ²² 28W - 28 W output, up to 1615 lm DUO ²² 28W - 28 W output, up to 1650 lm		3STP - 3 Step MacAdam Ellipse	90CRI - 90 CRI	SOLA 30K18K - 3000K to 1800K 27K18K - 2700K to 1800K DUO 65K27K - 6500K to 2700K 50K27K - 5000K to 2700K
TRIM STYLE	LENS		BAFFLE FINISH	TRIM FLANGE FINISH		
Specify same as Housing				Specify NA for Trimless		
	WW					
TRM - Flanged trim TLMP - Trimless drywall mudplate TLMW ²⁵ - Trimless millwork ²⁵ For remodel (RM) installation type, TLMW adapter must be installed from above the ceiling or before ceiling is installed.	WW - Wall wash diffuser		FTMW - Textured matte white FTMB - Textured matte black FSPC - Specular FSSPC - Semi-specular FCHP - Champagne CF# - Custom finish, specify RAL#	FTMW - Textured matte white FTMB - Textured matte black FSPC - Specular FSSPC - Semi-specular FCHP - Champagne CF# - Custom finish, specify RAL# NA - Not applicable		



ECANA 6" DOWNLIGHT

SQUARE RECESSED WALL WASH



Housing

INSTALLATION TYPES		
OF - Open Frame Type Non-IC	IC - Type-IC	CP - Chicago Plenum Type-IC (CCEA) AT - Airtight Type-IC
RM - Remodel Type Non-IC		
Integral	Remote	

- For height dimension C, see the PLENUM CLEARANCE & CUT-OUT DIMENSIONS table below.
 - For OF, IC, CP, and AT installation types with remote dimming, a remote driver box is provided.

REMOTE DRIVER BOX

RDB8 / RDB18 / RDB24

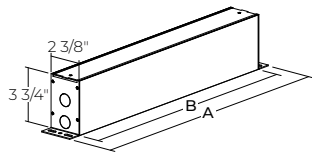

RDB24W

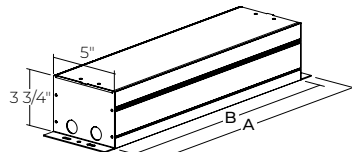

	RDB8	RDB18	RDB24	RDB24W
A	10"	20"	26"	26"
B	8"	18"	24"	24"
DRIVER	RD1 - 1% 0-10V RELV - ELV 120V RTRI - TRIAC 120V RPEQ0 - Lutron Hi-lume Premier 0.1% EcoSystem SOLA RSD1 - Single 0-10V input RSELV - ELV 120V RSTRI - TRIAC 120V	RLDE1 - Lutron Hi-lume 1% Eco RDA - DALI RELD1 - eldoLED 1% ECOdrive 0-10V RELD0 - eldoLED 0.1% SOLOdrive 0-10V	Emergency battery (+EB) with the following driver options. RD1+EB - 1% 0-10V RELV+EB - ELV 120V RTRI+EB - TRIAC 120V RPEQ0+EB - Lutron Hi-lume Premier 0.1% EcoSystem DJ0 RDMX - DMX RDDA - DALI DT6 RDDA8 - DALI DT8 RDD1 - Dual 0-10V input for CCT/intensity RLD2 - Lutron DALI-2 digital	Emergency battery (+EB) with the following driver options. RLDE1+EB - Lutron Hi-lume 1% Eco RDA+EB - DALI RELD1+EB - eldoLED 1% ECOdrive 0-10V RELD0+EB - eldoLED 0.1% SOLOdrive 0-10V

PLENUM CLEARANCE & CUT-OUT DIMENSIONS

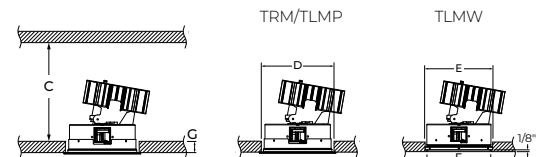

PLENUM CLEARANCE HEIGHT		
REMOTE & INTEGRAL		
C	OF	6" (20 W/24 W/28 W)
	IC/CP/AT	7" (40 W/48 W)
	RM	9 5/8"
CUT-OUT DIMENSIONS		
D	TRM/ TLMP	6 1/2" x 6 1/2"
E	TLMW	6 1/2" x 6 1/2"
F		6 1/16" x 6 1/16" with 1/8" lip
MAXIMUM CEILING THICKNESS		
G	TRM/ TLMP	1 1/2"
	TLMW	5/8"

ECANA 6" DOWNLIGHT

SQUARE RECESSED WALL WASH



Housing

MOUNTING OPTIONS

ASB - Adjustable Standard Bar Hangers

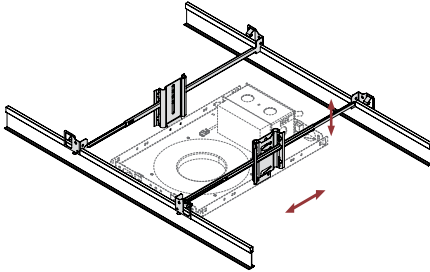

Adjustable Standard Bar hangers can be used in both commercial and residential applications and are adjustable to various heights in both Grid Ceiling and Drywall mounting. ASB hangers are less rigid and versatile than ACB hangers.

FMB - Flush Mount Bars

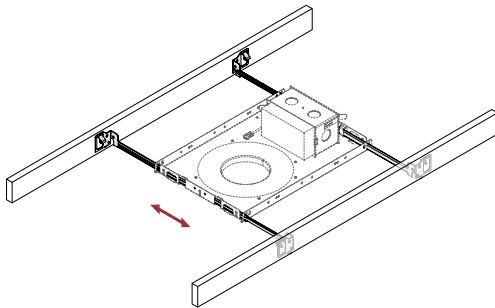

Flush Mount Bars are best used in residential applications, fitting snug to the surface and suitable for Wood, Metal, and Drywall mounting. The flush mounted bars are static and can't be adjusted.

ACB - Adjustable Commercial Bar Hangers

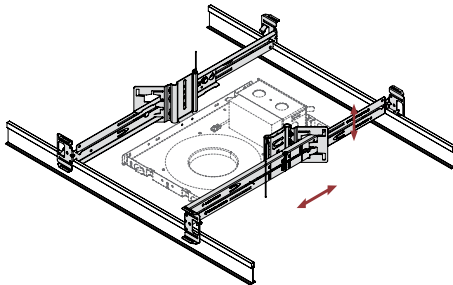

Adjustable Commercial Bar hangers can be used in both commercial and residential applications and are by far the most versatile mounting bar we offer with its adjustability to various heights. ACB hangers are suitable for Grid Ceiling, Drywall, Metal, Wood and Frame mounting.

- Extremely rigid
- Fits into C-Channel notches in a Butterfly Bracket

AHC - Adjustable Hat Channel Bars

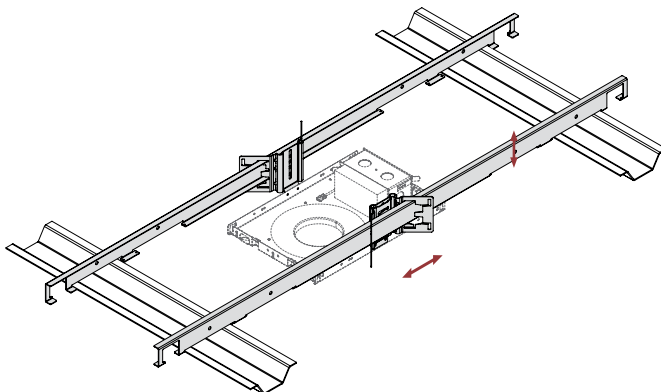

Adjustable Hat Channel bars can be used in both commercial and residential applications and come with a butterfly clip to adjust to various heights. AHC bars can be hung downward by 90 degrees in vertical position, and once wired, can be shifted onto the horizontal mounting plane. AHC bars are suitable for both Drywall and wood ceiling applications.

ECANA 6" DOWNLIGHT

SQUARE RECESSED WALL WASH



Light & Baffle

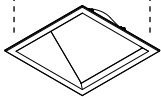
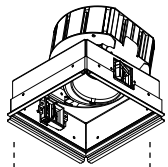

Flanged
Trim

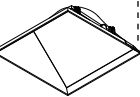
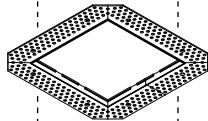
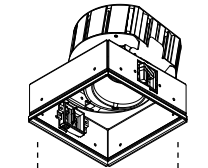

Trimless
Drywall
Mudplate

Mudplate
OD - 9 3/8" x 9 3/8"

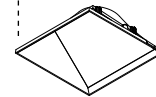
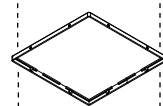
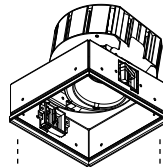

Trimless
Millwork

Millwork
Adapter

TRM Flanged Trim	TLMP/TLMW Trimless Drywall Mudplate /Trimless Millwork
<p> Baffle finish Trim flange finish </p>	

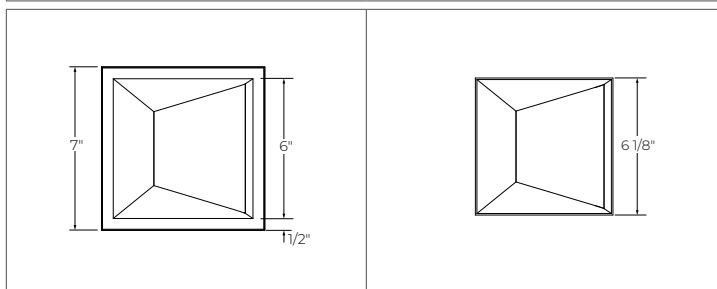

ECANA 6" DOWNLIGHT

SQUARE RECESSED WALL WASH



Color Quality

COLOR QUALITY - 3500K	
TM-30 R _r	91
TM-30 R _g	99
CRI	90
R9	> 50

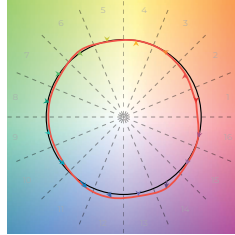

Photometrics

Values calculated with white wall wash baffle, and based on 3500K for static white.

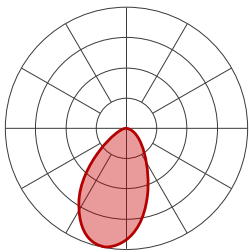

STATIC WHITE

CRI	90 CRI		95 CRI		80 CRI	
	lm	lm/W	lm	lm/W	lm	lm/W
20 W	1136	57	966	48	1136	57
28 W	1525	54	1296	46	1525	54
40 W	2413	60	2051	51	2413	60
48 W	2818	59	2395	50	2818	59

SOLA

		lm	lm/W
28 W	3000K	1615	58
	2700K	1615	58

DUO

		lm	lm/W
28 W	6500K	1650	59
	5000K	1650	59
	2700K	1450	52

MULTIPLIERS

Please follow the multiplier tables to ensure correct lumen value. CCT and baffle colors will change the lumen value.

CCT	
2400K	0.87
2700K	0.94
3000K	0.98
3500K	1
4000K	1.05
5000K	1.05

TRIM STYLE AND BAFFLE FINISH	
Flanged trim	1
Trimless	1
White	1
Black	1

ECANA 6" DOWNLIGHT

SQUARE RECESSED WALL WASH



Technical Specifications

OPTIC

XPoint™ Refraction Technology optics provide precise optical control in a remarkably compact form. Micro optical paths from the chip on board converge and then disperse in precise beam angles, resulting in a crisp and exacting light quality.

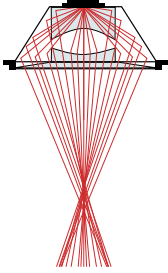

LIGHT SOURCE

Static white

Compact COB (Chip-On-Board) LED module, available in 2400K, 2700K, 3000K, 3500K, 4000K, and 5000K with a choice of 80 CRI, 90 CRI, or 95 CRI, with elevated R9 value for 90 CRI and above. Color consistency is maintained to within 2 SDCM. All LEDs have been tested in accordance with IESNA LM-80-08 and the results have shown L80 lumen maintenance greater than 60,000 hours. Absolute product photometry is measured and presented in accordance with IESNA LM-79, unless otherwise indicated. Optional full spectrum LEDs can be incorporated in the fixture to increase Cyanosis Observation Index (COI) and assist in regulating circadian rhythms.

Chromawerx SOLA

Chromawerx SOLA is single-channel control that dims output while warming the color temperature in a pre-determined relationship. Two color temperature range options are offered: 3000K to 1800K, and 2700K to 1800K. A simple analog control adjusts a specially populated LED array to emulate the effect of dimming a filament source.

Chromawerx DUO

Chromawerx DUO offers a two-channel control system which uses analog or digital protocols for synchronous control of both cool to warm LED arrays - maintaining a CRI above 90. Two color temperature range options are offered: 6500K to 2700K, and 5000K to 2700K. The range of color DUO offers is useful for entraining circadian rhythms, stimulating alertness, and compensating for jet lag among other applications. The Chromawerx drivers are programmed to limit maximum light output and power usage across all color temperatures. When paired with DALI drivers (DDA/DDA8), color tuning follows a linear dimming curve.

ELECTRICAL

Unless otherwise specified, dimming down to 1%. At maximum driver load: efficiency>84%, PF>0.9, THD<20%.

Integral: 0-10V, ELV, TRIAC, Lutron Hi-Lume 1% EcoSystem, DALI, eldoLED 0.1% SOLOdrive 0-10V, eldoLED 1% ECOdrive 0-10V, DMX, Lutron DALI-2 digital

Remote: 0-10V, ELV, TRIAC, Lutron Hi-Lume 1% EcoSystem, DALI, eldoLED 0.1% SOLOdrive 0-10V, eldoLED 1% ECOdrive 0-10V, DMX, Lutron DALI-2 digital

Emergency battery options - Integral: Factory installed, long-life, high-temperature, LED driver with integrated emergency backup using a recyclable LiFePO4 battery pack. Features a remote test switch with charge indicator, minimum of 90 minutes operation and 10 W per downlight emergency lighting output. Recharge time of 12 hours.

Emergency battery options - Remote: Remotely-installed, long-life, high-temperature, maintenance-free, Bodine Lithium-Ion battery pack with self-test functionality, test switch and charge indicator. IOTA and Fulham options available upon request. Minimum of 90 minutes operation, and recharge time of 24 hours. For fixtures less than 10 W, the battery provides 6 W of emergency light output. For fixtures 10 W and over, the battery provides 10 W.

PoE

Depending on the PoE manufacturer selected, Lumenwerx will install the node in factory as either integral to the luminaire or as a remote module. Factory programming of the PoE node may or may not enable the following functionalities: lumen package, DUO (tunable white), QUADRO (RGBW), emergency battery backup, and sensor integration. These must be addressed and evaluated on a case-by-case basis.

ECANA 6" DOWNLIGHT

SQUARE RECESSED WALL WASH



CONSTRUCTION

Housing

For new construction, 20 gauge powder coated steel. Open frame, type-IC, or Chicago Plenum (CCEA) rated. 18 gauge galvanized steel junction box with ½" trade size knockouts. Adjustable standard, flush mount, adjustable commercial, and adjustable hat channel bar hangers are available as mounting options.

Light element

LED module: Integral COB module. 90 CRI and 2 SDCM, Standard with options of 80 CRI, or 95 CRI. L80 > 60,000 hours.

XPoint™ Refraction Technology optic: Micro optical paths from the chip on board converge and then disperse in precise beam angles, resulting in a crisp and exacting light quality.

Thermal management: Die-cast aluminum heat sink to maximize thermal dissipation.

Baffle: Die-cast aluminum mounted with retaining spring clips

Trim style: Trimmed and trimless with mudplate or millwork adapter

WEIGHT

Open frame: 7 lbs - 3.2 kg

Type-IC/Chicago Plenum: 13 lbs - 6 kg

Remodel: 5 lbs - 2.3 kg

ENVIRONMENT

Ambient temperature at fixture location shall be within 0°C/32°F - 25°C/77°F, indoor dry or damp as well as outdoor damp use (canopies or marquees).

CERTIFICATIONS

ETL: Rated for indoor dry/damp locations. Conforms to UL Standard 1598 and certified to CAN/CSA Standard C22.2 No. 250.0.

Chicago Plenum: City of Chicago approved (CCEA) when specified with CP installation type option.

IC rated: Suitable for direct contact with insulation when specified with IC, CP or AT installation type options.

Declare: [LBC Red List Approved](#)

WARRANTY

Lumenwerx provides a five-year limited warranty on electrical and mechanical performance of the luminaires, including the LED boards, drivers, and auxiliary electronics. Lumenwerx will repair or replace defective luminaires or components at our discretion, provided they have been installed and operated in accordance with our specifications. Other limitations apply, please refer to the full warranty on our website.