

FORTEX 1 LED

SURFACE - WALL

INWARD LIGHT DISTRIBUTION

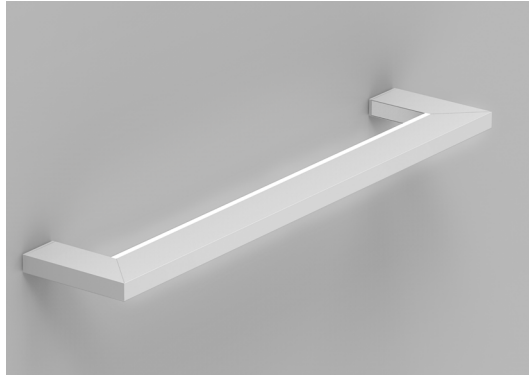

PROJECT: _____

TYPE: _____

NOTES: _____

DESCRIPTION

Fortex 1 is a distinctive and elegantly scaled wall luminaire whose horizontal form extends 6" from the wall and is intended for installation at least 80" above the floor. The luminaire consists of crisp 3.75" x 1.5" extruded aluminum sides, capped by a gently glowing inward optic that extends 0.5" beyond the housing. Corners are mitered. Fortex coordinates with Via 1.5 Plus linear luminaires.

ORDER GUIDE

FOR1SWI	HLO	SW			
LUMINAIRE ID	OPTICS	LIGHT SOURCE	CRI	LUMEN PACKAGES	COLOR TEMP.
FOR1SWI - Fortex 1 surface - wall inward light distribution	HLO - High-Efficiency Lambertian Optic	SW - Static white	80 - 80CRI 90 - 90CRI	200 - min. ultra low output 200lm/ft (not available for 18") 400 - max. low output 400lm/ft #### - other required lm/ft	27 - 2700k 30 - 3000k 35 - 3500k 40 - 4000k

			1	DMB		
LUMINAIRE LENGTH	VOLTAGE	DRIVER	ELECTRICAL	MOUNTING	FINISH	OPTIONS
18IN - 18"	120 - 120V	D1 - 1% dimming 0-10V	1 - 1 circuit	DMB - drywall mounting bracket	W - matte white AL - aluminum CF# - custom finish specify RAL#	CU - custom
2FT - 2'	277 - 277V	DA - Dali				
3FT - 3'	UNV - 120V-277V	LDE1 - Lutron Hi-lume 1% Eco				
4FT - 4'						

See page 2 for ordering code detailed information

SECTION VIEW

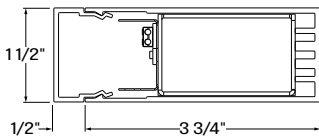

FOR1SWI

3D VIEW

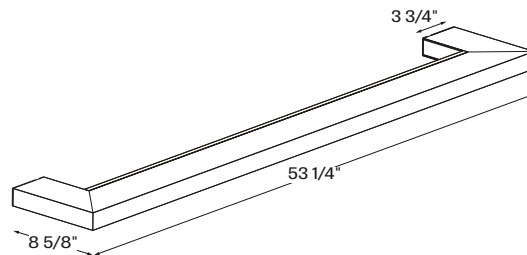

FOR1SWI - 4'

OPTICS



HLO - High-efficiency Lambertian Optic

FORTEX 1 LED

SURFACE - WALL

LUMENWERX
WWW.LUMENWERX.COM

INWARD LIGHT DISTRIBUTION

OPTICS

HIGH EFFICIENCY LAMBERTIAN OPTIC (HLO) - Matte white side reflectors combined with High-Efficiency Lambertian Optic (HLO) shielding of diffusing 0.075" thick acrylic with up to 88% transmission and good source obscuration. Luminaire brightness is controlled by the flux-to-shielding area ratio.

LIGHT SOURCE - LED

Custom linear array of mid-flux LED's are cartridge-mounted with quick-connect wiring to facilitate service and thermal management. Available in 3000K, 3500K and 4000K with a minimum 80 CRI and an option for 90 CRI with elevated R9 value. Color consistency maintained to within 3 SDCM. LEDs operated at reduced drive current to optimize efficacy and lumen maintenance. All LEDs have been tested in accordance with IESNA LM-80-08 and the results (following TM-21) have shown L80 lumen maintenance greater than 60,000 hours. Absolute luminaire photometry is measured and presented in accordance with IESNA LM-79, unless otherwise indicated.

PERFORMANCE PER 1' AT 4000K

LED output	Color Temp	Watts	Nominal Delivered Lumens	Efficacy LPW
low output	4000K	2	200	89
medium output	4000K	4.5	400	90

LUMINAIRE LENGTH

Fortex 1 surface - wall is offered in 4 standard length, 18", 2', 3' and 4'.

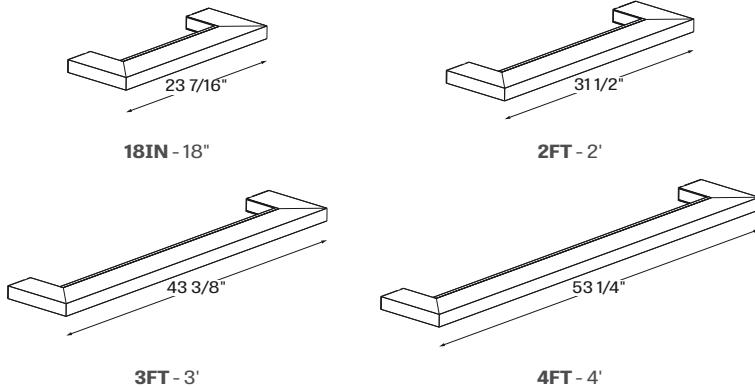

ELECTRICAL

Factory-set, adjustable output current LED driver with universal (120-277VAC) input. Dimmable from 100% to 1% with 0-10V dimming control. Rated life (90% survivorship) of 50,000 hours at 50°C max. ambient (and 70°C max. case) temperature. At maximum driver load: Efficiency > 84%, PF > 0.9, THD < 20%. Other specifiable options include Lutron Hi-Lume 1% Eco and DALI protocol drivers. All of our standard 0-10V drivers are NEMA 410 compliant.

MOUNTING OPTIONS

The mounting bracket installs on to the wall using drywall anchors or secured into stud, and is finished to match the luminaire. Electrical connection is made using pre-existing flexwhip to avoid visible junction box.

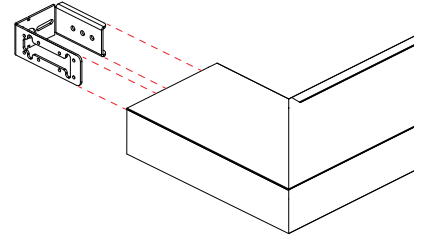

FINISH

Interior - 95%, reflective matte powder coated white paint
Exterior - matte white or aluminum powder coating. Custom finishes are also available.

CONSTRUCTION

Housing - Extruded Aluminum (0.095" nominal) up to 90% Recycled Content
Interior brackets - Die formed cold rolled sheet steel 18 gauge thick
Mounting bracket - Cold rolled steel (14GA & 11 GA)
Reflectors - Cold rolled steel 0.024" thick precisely die formed, 95% reflective matte white painted

WEIGHT

Fortex 1 - 18In - 5.72lbs - 2.59kg
Fortex 1 - 2ft - 6.40lbs - 2.90kg
Fortex 1 - 3ft - 7.97lbs - 3.62kg
Fortex 1 - 4ft - 9.08lbs - 4.12kg

CERTIFICATIONS

ETL - Rated for Indoor Dry/Damp locations. Conforms to UL Standard 1598 and certified to CAN/CSA Standard C22.2 No. 250.0.

WARRANTY

LumenWerx provides a five-year limited warranty of electrical and mechanical performance of the luminaires, including the LED boards, drivers, and auxiliary electronics. LumenWerx will repair or replace defective luminaires or components at our discretion, provided they have been installed and operated in accordance with our specifications. Other limitations apply, please refer to the full warranty on our website.

FORTEX 1 LED

SURFACE - WALL

INWARD LIGHT DISTRIBUTION

200 LUMEN AT 80CRI - ULTRA LOW OUTPUT

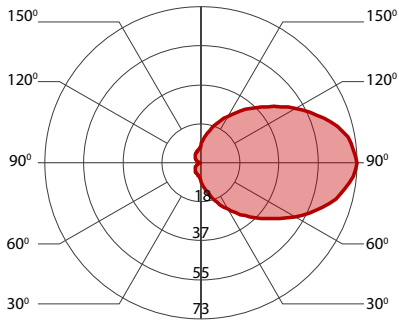

PERFORMANCE PER 1'

LED output	Color Temp	Watts	Nominal Delivered Lumens	Efficacy LPW
ultra low output	3000K	2.5	200	83
ultra low output	3500K	2.5	200	86
ultra low output	4000K	2	200	89

400 LUMEN AT 80CRI - LOW OUTPUT

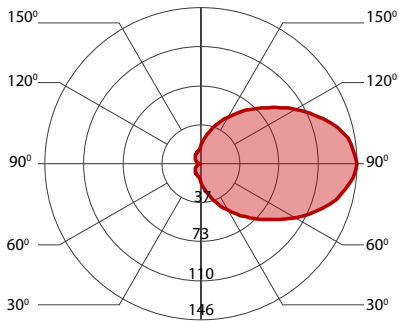

PERFORMANCE PER 1'

LED output	Color Temp	Watts	Nominal Delivered Lumens	Efficacy LPW
low output	3000K	5	400	84
low output	3500K	4.5	400	87
low output	4000K	4.5	400	90