

FORTEX 1 LED

SURFACE - WALL

OUTWARD/INWARD LIGHT DISTRIBUTION

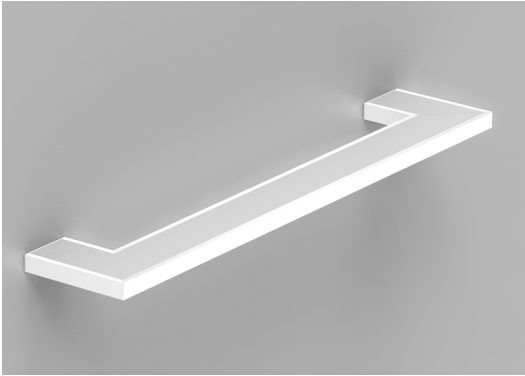

PROJECT: _____
 TYPE: _____
 NOTES: _____

DESCRIPTION

Fortex 1 is a distinctive and elegantly scaled wall luminaire. The horizontal form extends 9" from the wall and is intended for installation at least 80" above the floor. The luminaire consists of crisp 4.25" x 1.5" extruded aluminum sides, capped by a gently glowing inward and outward optics that extend 0.5" beyond the housing. Corners are mitered and fully luminous. Fortex coordinates with Via 1.5 Plus linear luminaires.

ORDER GUIDE

FOR1SWOI	HLO	SW			
LUMINAIRE ID	OPTICS	LIGHT SOURCE	CRI	DIR/IND LUMEN PACKAGES	COLOR TEMP.
FOR1SWOI - fortex 1 surface - wall outward/inward light distribution	HLO - High-Efficiency Lambertian Optic	SW - Static white	80 - 80CRI 90 - 90CRI	200 - min. ultra low output 200lm/ft 400 - max. low output 400lm/ft #### - other required lm/ft	27 - 2700k 30 - 3000k 35 - 3500k 40 - 4000k

LUMINAIRE LENGTH	VOLTAGE	DRIVER	ELECTRICAL	MOUNTING	FINISH	OPTIONS
18IN - 18" 3FT - 3' 4FT - 4'	120 - 120V 277 - 277V UNV - 120V-277V	D1 - 1% dimming 0-10V DA - Dali LDE1 - Lutron Hi-Lume 1% Eco *18" is only available with dimming 0-10V	1 - 1 circuit	DMB - drywall mounting bracket	W - matte white AL - aluminum CF# - custom finish specify RAL#	CU - custom

See page 2 for ordering code detailed information

SECTION VIEW

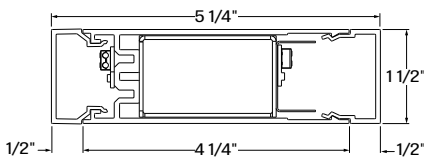

FOR1SWOI

3D VIEW

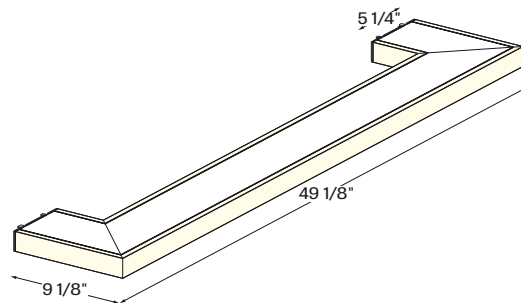

FOR1SWOI - 4'

OPTICS



HLO - High-efficiency Lambertian Optic

FORTEX 1 LED

SURFACE - WALL

OUTWARD/INWARD LIGHT DISTRIBUTION

OPTICS

HIGH EFFICIENCY LAMBERTIAN OPTIC (HLO) - Matte white side reflectors combined with High-Efficiency Lambertian Optic (HLO) shielding of diffusing 0.075" thick acrylic with up to 88% transmission and good source obscuration. Luminaire brightness is controlled by the flux-to-shielding area ratio.

LIGHT SOURCE - LED

Custom linear array of mid-flux LED's are cartridge-mounted with quick-connect wiring to facilitate service and thermal management. Available in 3000K, 3500K and 4000K with a minimum 80 CRI and an option for 90 CRI with elevated R9 value. Color consistency maintained to within 3 SDCM. LEDs operated at reduced drive current to optimize efficacy and lumen maintenance. All LEDs have been tested in accordance with IESNA LM-80-08 and the results (following TM-21) have shown L80 lumen maintenance greater than 60,000 hours. Absolute luminaire photometry is measured and presented in accordance with IESNA LM-79, unless otherwise indicated.

PERFORMANCE PER 1' AT 4000K

LED output	Color Temp	Watts	Nominal Delivered Lumens	Efficacy LPW
low output	4000K	2.5	200	88
medium output	4000K	4	400	97

LUMINAIRE LENGTH

Fortex 1 surface - wall is offered in 3 standard length, 18", 3' and 4'.

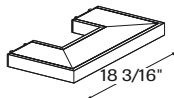

18IN - 18"

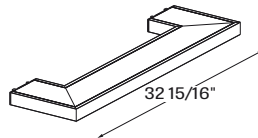

3FT - 3'

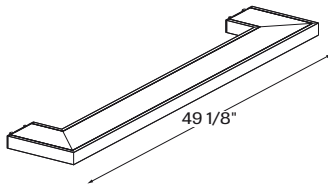

4FT - 4'

ELECTRICAL

Factory-set, adjustable output current LED driver with universal (120-277VAC) input. Dimmable from 100% to 1% with 0-10V dimming control. Rated life (90% survivorship) of 50,000 hours at 50°C max. ambient (and 70°C max. case) temperature. At maximum driver load: Efficiency > 84%, PF > 0.9, THD < 20%. Other specifiable options include Lutron Hi-Lume 1% Eco and DALI protocol drivers. All of our standard 0-10V drivers are NEMA 410 compliant.

MOUNTING OPTIONS

The mounting bracket installs on to the wall using drywall anchors or secured into stud, and is finished to match the luminaire. Electrical connection is made using pre-existing flexwhip to avoid visible junction box.

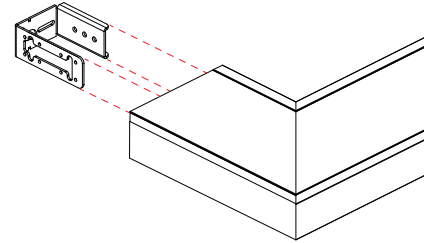

FINISH

Interior - 95%, reflective matte powder coated white paint
Exterior - matte white or aluminum powder coating. Custom finishes are also available.

CONSTRUCTION

Housing - Extruded Aluminum (0.095" nominal) up to 90% Recycled Content
Interior brackets - Die formed cold rolled sheet steel 18 gauge thick
Mounting bracket - Cold rolled steel (14GA & 11 GA)
Reflectors - Cold rolled steel 0.024" thick precisely die formed, 95% reflective matte white painted

WEIGHT

Fortex 1 - 18In - 6lbs - 2.72kg
Fortex 1 - 3ft - 8.92lbs - 4.05kg
Fortex 1 - 4ft - 11.24lbs - 5.10kg

CERTIFICATIONS

ETL - Rated for Indoor Dry/Damp locations. Conforms to UL Standard 1598 and certified to CAN/CSA Standard C22.2 No. 250.0.

OUTWARD/INWARD LIGHT DISTRIBUTION

WARRANTY

LumenWerx provides a five-year limited warranty of electrical and mechanical performance of the luminaires, including the LED boards, drivers, and auxiliary electronics. LumenWerx will repair or replace defective luminaires or components at our discretion, provided they have been installed and operated in accordance with our specifications. Other limitations apply, please refer to the full warranty on our website.

FORTEX 1 LED

SURFACE - WALL

OUTWARD/INWARD LIGHT DISTRIBUTION

200 LUMEN AT 80CRI - ULTRA LOW OUTPUT

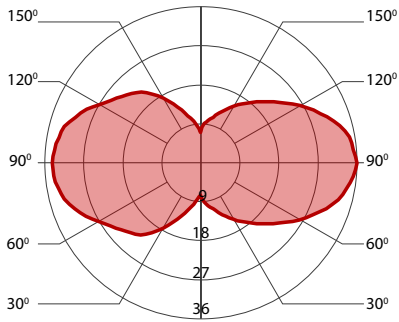

PERFORMANCE PER 1'

LED output	Color Temp	Watts	Nominal Delivered Lumens	Efficacy LPW
ultra low output	3000K	2.5	200	83
ultra low output	3500K	2.5	200	85
ultra low output	4000K	2.5	200	88

400 LUMEN AT 80CRI - LOW OUTPUT

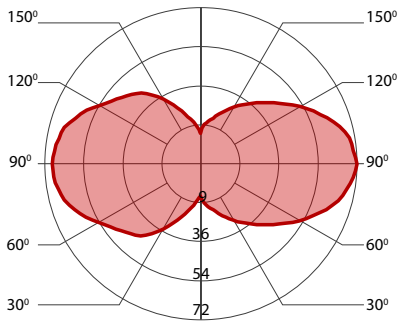

PERFORMANCE PER 1'

LED output	Color Temp	Watts	Nominal Delivered Lumens	Efficacy LPW
low output	3000K	4.5	400	91
low output	3500K	4.5	400	94
low output	4000K	4	400	97