

HEMI L

DOWNLIGHT RECESSED



3" Module
+ Soft Ambient



2" Module
+ Soft Ambient



2" Modules
+ Soft Ambient



Soft Ambient

Hemi is a line of hemisphere-shaped luminaires designed with exceptional rotational and tilt capabilities and a sleek aiming mechanism allowing for a vast range of precisely positioned solutions for both task and ambient requirements.

Beam Angles



Performance

| ADJ. MODULE | LUMEN OUTPUT ¹ | WATTS | EFFICACY |
|-------------|---------------------------|-------|----------|
| 3" Module | 2037 lm | 20 W | 102 lm/W |
| 2" Module | 1338 lm | 14 W | 96 lm/W |

¹Lumen packages are assuming 3500K, 80 CRI, 30° beam.

| AMBIENT | LUMEN OUTPUT ² | WATTS | EFFICACY |
|--------------|---------------------------|-------|----------|
| Soft Ambient | 630 lm | 16 W | 39 lm/W |

²Lumen packages are assuming 3500K, 80 CRI, white dome finish.

Light Source

- Static White
- Full Spectrum
- SOLA - Dim-to-Warm
- DUO - Tunable White
- TRIO - Three-channel Red, Green, Blue



COB

- 2 Step Color Binning
- Up to 95 CRI

Driver

- 1%, 0.1% Dimming Available
- 0-10V, TRIAC, ELV, Lutron EcoSystem, DALI, DMX

Configurations

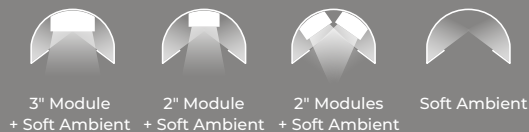

Ceiling Types



Installation Types

- New Construction (Type Non-IC)
- Remodel (Type Non-IC)

Plenum Clearance

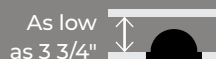

HEMI L

DOWNLIGHT RECESSED



Project: _____

Type: _____

Order Guide

1 - Housing

Example: HEMLR-ADJIX3IN-AMBSA-TRM-SW-SW-OF-ASB-120V-14W-4W-D1-D1

| LUMINAIRE ID | CONFIGURATION ADJUSTABLE MODULE | CONFIGURATION AMBIENT | TRIM STYLE | LIGHT SOURCE ADJUSTABLE MODULE | LIGHT SOURCE AMBIENT | INSTALLATION TYPE ² | MOUNTING OPTION ³ | | | |
|--|---|--|--|---|--|--|---|---------------------------------|--|--|
| HEMLR | | | | | | | | | | |
| HEMLR - Hemi L Recessed | ADJIX3IN - One 3" module ADJIX2IN - One 2" module ADJ2X2IN - Two 2" modules ADJNA - None | AMBSA - Soft ambient AMBNA - None | TRM - Flanged trim TLMP - Trimless drywall mudplate TLMW ¹ - Trimless millwork ¹ For remodel (RM) installation type, TLMW adapter must be installed from above the ceiling or before ceiling is installed. | SW - Static white FS - Full spectrum SOLA - Dim-to-warm single channel control 35K to 22K DUO - Tunable white 2-channel control 65K to 27K NA - Not applicable | SW - Static white SOLA - Dim-to-warm single channel control 35K to 22K DUO - Tunable white 2-channel control 65K to 27K TRIO - Three-channel Red, Green, Blue NA - Not applicable | OF - Open Frame Type Non-IC RM - Remodel Type Non-IC ² Consult factory for Type-IC (IC/CP). | ASB ⁴ - Adjustable standard bar hangers FMB ⁴ - Flush mount bars ACB ⁴ - Adjustable commercial bar hangers AHC ⁴ - Adjustable hat channel bars NA - None ³ See page 4 for more details. ⁴ Not available with RM installation type. | | | |
| VOLTAGE | | WATTAGE ADJUSTABLE MODULE ⁵ | | WATTAGE AMBIENT ⁵ | | DIMMING ADJUSTABLE MODULE ^{9,10} | | DIMMING AMBIENT ^{9,10} | | |
| TOTAL WATTAGE MUST NOT EXCEED 30 W | | | | | | | | | | |
| 120V - 120V 277V - 277V | 3" module | | 2" module ⁷ | | Soft ambient | | SW | | TRIO ¹⁴ DMX ¹⁵ - DMX | |
| | SW/FS ⁶ | | 14W - 14 W output, up to 1532 lm 20W - 20 W output, up to 2078 lm | | SW | | 4W - 4 W, up to 176 lm 10W - 10 W, up to 413 lm 16W - 16 W, up to 630 lm | | D1 - 1% 0-10V ELV ^{11,12} - ELV 120V TRI ^{11,12} - TRIAC 120V LDE1 ¹³ - Lutron Hi-lume 1% Eco DA ¹³ - DALI ELD1 - eldoLED 1% ECOdrive 0-10V ELDO - eldoLED 0.1% SOLOdrive 0-10V DMX ¹³ - DMX | |
| | SOLA | | 13W - 13 W output, up to 920 lm (20° only) 20W - 20 W output, up to 1585 lm (40° and up) | | SOLA | | 4W - 4 W, up to 176 lm 10W - 10 W, up to 413 lm 16W - 16 W, up to 630 lm | | DUO DMX ¹³ - DMX DDA ¹³ - DALI DT6 DDA8 ¹³ - DALI DT8 DD1 - Dual 0-10V input for CCT/intensity LD2 ¹¹ - Lutron DALI-2 digital | |
| | DUO | | 10W - 10 W output, up to 700 lm (20° only) 20W - 20 W output, up to 1200 lm (40° and up) | | DUO | | 4W - 4 W, up to 181 lm 10W - 10 W, up to 425 lm 16W - 16 W, up to 649 lm | | NA - Not applicable | |
| | TRIO | | 5W - 5 W output, up to 300 lm (20° only) 10W - 10 W output, up to 640 lm (40° and up) | | TRIO | | 6W - 6 W | | | |
| | | NA - Not applicable | | NA - Not applicable | | | | | | |
| THE TOTAL WATTAGE OF ALL THE MODULES AND AMBIENT MUST NOT EXCEED 30 W. | | | | | | | | | | |
| ⁶ Lumen outputs are reduced with full spectrum. See page 7 and 8 for details. | | | | | | | | | | |
| ⁷ Wattages are per module. | | | | | | | | | | |
| ⁸ Not available with two 2" modules (2X2IN). | | | | | | | | | | |
| ⁹ See table on page 6 for valid driver combinations. | | | | | | | | | | |
| ¹⁰ PoE (Power-over-Ethernet) compatible. Consult factory for details. | | | | | | | | | | |
| ¹¹ Available with 120V only. | | | | | | | | | | |
| ¹² Not available with Ambient. | | | | | | | | | | |
| ¹³ On-site commissioning is required. | | | | | | | | | | |
| ¹⁴ Not available with Adjustable module. | | | | | | | | | | |

2 - Light & Baffle

Example: HEMLL-ADJIX3IN(SW-10DEG-2STP-90CRI-27K-LS-FTMW)-AMBSA(SW-90CRI-27K)-TRM-FTMW-FTMW-FTMW

| LUMINAIRE ID | CONFIGURATION ADJUSTABLE MODULE ¹⁵ | CONFIGURATION AMBIENT ¹⁶ | TRIM STYLE | BAFFLE FINISH | TRIM FLANGE FINISH | DOME FINISH |
|-----------------------|--|---|--|--|---|--|
| HEMLL | | | | | | |
| HEMLL - Hemi L | ADJIX3IN() - One 3" module ADJIX2IN() - One 2" module ADJ2X2IN() - Two 2" modules ADJNA - None ¹⁵ See Adjustable module specification below to specify options between the parentheses. | AMBSA() - Soft ambient AMBNA - None ¹⁶ See Ambient specification below to specify options between the parentheses. | TRM - Flanged trim TLMP - Trimless drywall mudplate TLMW ¹⁷ - Trimless millwork ¹⁷ For remodel (RM) installation type, TLMW adapter must be installed from above the ceiling or before ceiling is installed. | FTMW - Textured matte white FTMB - Textured matte black CF# - Custom finish, specify RAL# | FTMW - Textured matte white FTMB - Textured matte black CF# - Custom finish, specify RAL# NA - Not applicable (specify for Trimless) | FTMW - Textured matte white FTMB ¹⁸ - Textured matte black CF# - Custom finish, specify RAL# ¹⁸ Not available when specified with Ambient. |

Adjustable Module Specification

Ambient Specification

| ADJUSTABLE MODULE ID | LIGHT SOURCE ADJUSTABLE MODULE | BEAM | COLOR QUALITY | CRI ADJUSTABLE MODULE | COLOR TEMP. ADJUSTABLE MODULE | OPTICAL OPTIONS ²³ | MODULE FINISH | AMBIENT ID | LIGHT SOURCE AMBIENT | CRI AMBIENT | COLOR TEMP. AMBIENT |
|---|---|--|--|--|--|---|--|----------------|--|--|--|
| ADJIX3IN() ADJIX2IN() ADJ2X2IN() | SW - Static white FS - Full spectrum SOLA - Dim-to-warm single channel control 35K to 22K DUO - Tunable white 2-channel control 65K to 27K | 10DEG ¹⁹ - 10° Narrow spot 20DEG - 20° Spot 30DEG ¹⁹ - 30° Narrow flood 40DEG - 40° Flood 50DEG - 50° Wide flood ¹⁹ Not available for SOLA and DUO. | 2STP ²⁰ - 2 Step MacAdam Ellipse 3STP - 3 Step MacAdam Ellipse ²⁰ Available with static white (SW) only. | 90CRI ²¹ - 90 CRI 95CRI ²² - 95 CRI 80CRI ^{21,22} - 80 CRI ²¹ Not available with full spectrum. ²² Not available with SOLA/ DUO. | 27K - 2700K 30K - 3000K 35K - 3500K 40K - 4000K SOLA - Dim-to-warm single channel control 35K to 22K DUO - Tunable white 2-channel control 65K to 27K | LS - Linear spread HEX ²⁴ - Hex louver SNB - Snoot, black SNW - Snoot, white HSNB - Half snoot, black HSNW - Half snoot, white NA - None ²³ Maximum 1 accessory for each module. ²⁴ Always in textured matte black. | FTMW - Textured matte white FTMB - Textured matte black CF# - Custom finish, specify RAL# | AMBSA() | SW - Static white SOLA - Dim-to-warm single channel control 35K to 22K DUO - Tunable white 2-channel control 65K to 27K TRIO - Three-channel Red, Green, Blue | 90CRI - 90 CRI 95CRI ²⁵ - 95 CRI 80CRI - 80 CRI NA - Not applicable (specify for TRIO) ²⁵ Available with static white (SW) only. | 27K - 2700K 30K - 3000K 35K - 3500K 40K - 4000K SOLA - Dim-to-warm single channel control 35K to 22K DUO - Tunable white 2-channel control 65K to 27K TRIO - Three-channel Red, Green, Blue |



HEMI L

DOWNLIGHT RECESSED



Configurations

ADJ1X3IN - One 3" module

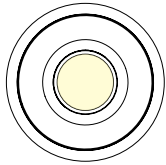

Bottom view

Rotation 355°
Tilt up to 40° from vertical

ADJ1X2IN - One 2" module

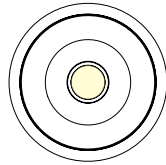

Bottom view

Rotation 355°
Tilt up to 30° from vertical

ADJ2X2IN - Two 2" modules

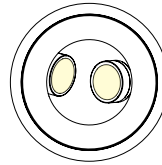

Bottom view

Rotation 355°
Tilt 25°-45°

AMBSA - Soft ambient

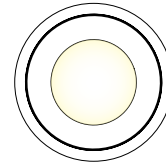

Bottom view

Housing

| INSTALLATION TYPES | |
|-----------------------------|--------------------------|
| OF - Open Frame Type Non-IC | RM - Remodel Type Non-IC |
| 1 driver | |
| | |
| 2 or 3 drivers ² | |
| | |

¹For height dimension A, see the PLENUM CLEARANCE & CUT-OUT DIMENSIONS table below.

²When 2 light elements are specified, two drivers are provided. When 3 light elements are specified, three drivers are provided.

PLENUM CLEARANCE & CUT-OUT DIMENSIONS

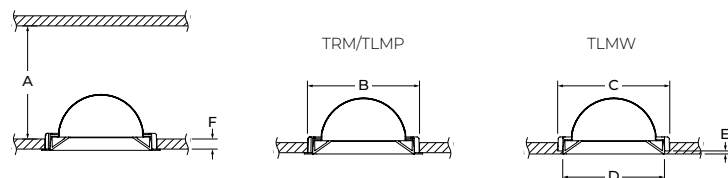

| PLENUM CLEARANCE HEIGHT | | |
|-------------------------|--------|--------|
| | OF | RM |
| A | 4 3/4" | 3 3/4" |

| CUT-OUT DIMENSIONS | | |
|--------------------|----------|----------|
| | TRM/TLMP | TLMW |
| B | Ø 7 1/4" | Ø 7 1/4" |
| C | Ø 7 1/4" | Ø 7 1/4" |
| D | Ø 6 3/8" | Ø 6 3/8" |
| E | 3/16" | 3/16" |

| MAXIMUM CEILING THICKNESS | |
|---------------------------|----|
| F | 1" |

HEMI L

DOWNLIGHT RECESSED

Housing

MOUNTING OPTIONS

ASB - Adjustable Standard Bar Hangers

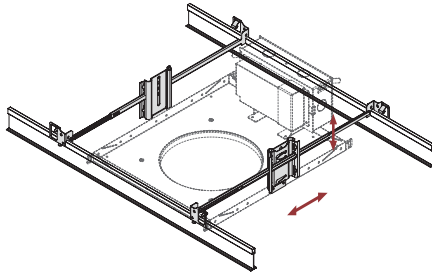

Adjustable Standard Bar hangers can be used in both commercial and residential applications and are adjustable to various heights in both Grid Ceiling and Drywall mounting. ASB hangers are less rigid and versatile than ACB hangers.

FMB - Flush Mount Bars

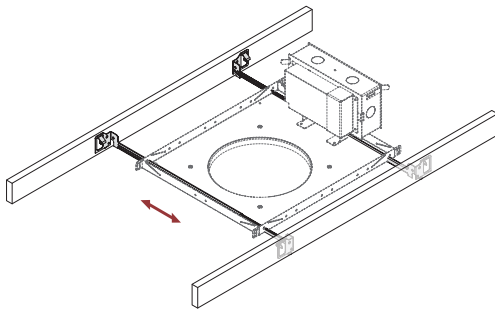

Flush Mount Bars are best used in residential applications, fitting snug to the surface and suitable for Wood, Metal, and Drywall mounting. The flush mounted bars are static and can't be adjusted.

ACB - Adjustable Commercial Bar Hangers

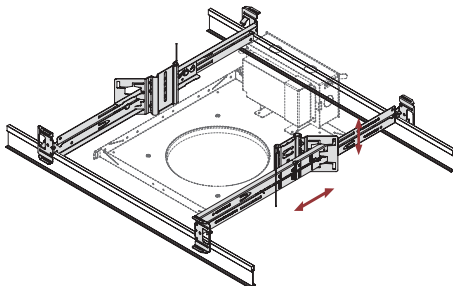

Adjustable Commercial Bar hangers can be used in both commercial and residential applications and are by far the most versatile mounting bar we offer with its adjustability to various heights. ACB hangers are suitable for Grid Ceiling, Drywall, Metal, Wood and Frame mounting.

- Extremely rigid
- Fits into C-Channel notches in a Butterfly Bracket

AHC - Adjustable Hat Channel Bars

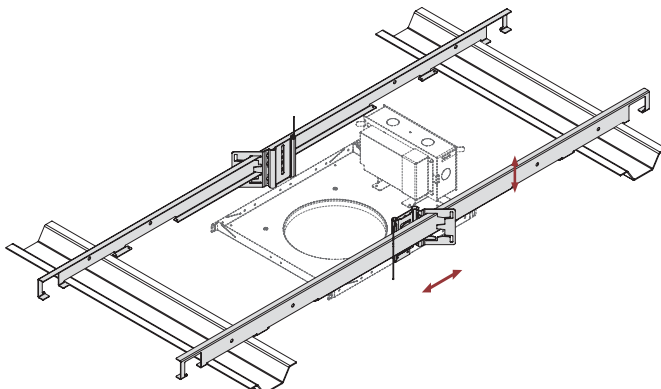

Adjustable Hat Channel bars can be used in both commercial and residential applications and come with a butterfly clip to adjust to various heights. AHC bars can be hung downward by 90 degrees in vertical position, and once wired, can be shifted onto the horizontal mounting plane. AHC bars are suitable for both Drywall and wood ceiling applications.

HEMI L

DOWNLIGHT RECESSED



Light & Baffle

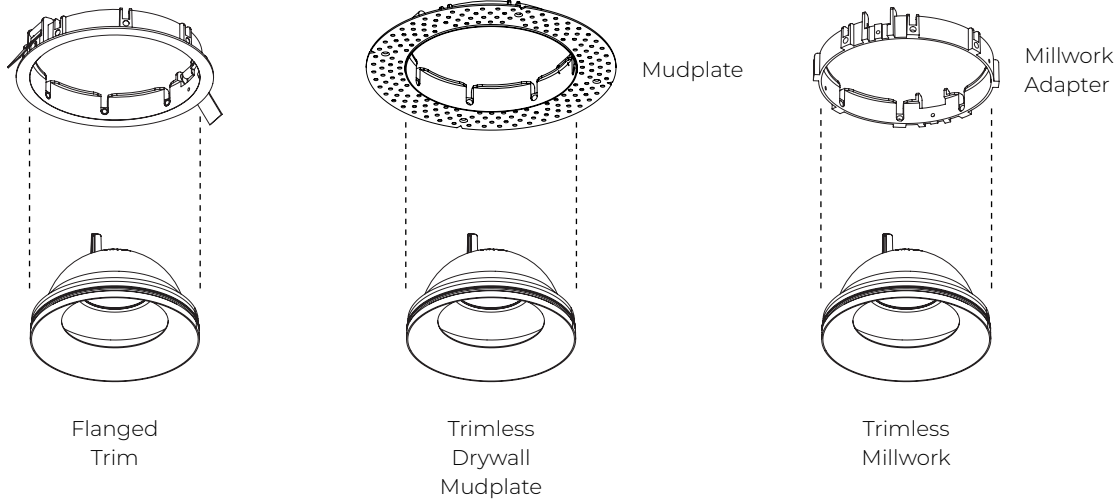

TRIM

| TRM Flanged Trim | TLMP/TLMW Trimless Drywall Mudplate /Trimless Millwork |
|--|--|
| | |
| <ul style="list-style-type: none"> Dome finish Baffle finish Trim flange finish | |
| | |
| | |

ADJUSTABLE MODULE & CUT-OFF/SHIELDING ANGLES

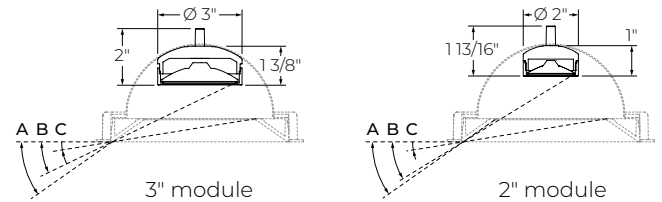

| CUT-OFF & SHIELDING ANGLES | | | |
|----------------------------|-------------------|-----------|-----------|
| | | 3" module | 2" module |
| A | SHIELDING | 35° | 35° |
| B | CUT-OFF (MODULE) | 26° | 32° |
| C | CUT-OFF (AMBIENT) | 9° | 9° |

Light source and driver combinations

Please follow the table to ensure correct driver options for light sources selected.

ADJUSTABLE MODULE - AMBIENT

SW - SW/SOLA/DUO/TRIO

| MODULE | AMBIENT | MODULE | AMBIENT | MODULE | AMBIENT | MODULE | AMBIENT |
|-------------------|---------------------|----------|---------|-----------------|-------------|-----------|---------|
| SW/FS | SW | SW/FS | SOLA | SW/FS | DUO | SW/FS | TRIO |
| D1 | + D1 | D1 + SD1 | | D1 | + DD1 | DMX + DMX | |
| DA ¹ | + DA | | | DA ¹ | + DDA, DDA8 | | |
| LDE1 ¹ | + LDE1 ² | | | DMX | + DMX | | |
| ELDO ¹ | + ELDO | | | | | | |
| ELD1 ¹ | + ELD1 | | | | | | |
| DMX | + DMX | | | | | | |

¹Not available with two 2" modules (2X2IN).

²Not available with 4 W.

SOLA - SW/SOLA/DUO/TRIO

| MODULE | AMBIENT | MODULE | AMBIENT | MODULE | AMBIENT |
|--------|---------|--------|---------|--------|---------|
| SOLA | SW | SOLA | SOLA | SOLA | DUO |
| SD1 | + D1 | SD1 | + SD1 | SD1 | + DD1 |

DUO - SW/SOLA/DUO/TRIO

| MODULE | AMBIENT | MODULE | AMBIENT | MODULE | AMBIENT | MODULE | AMBIENT |
|------------------------|---------|------------------------|---------|------------------------|-------------|-----------|---------|
| DUO | SW | DUO | SOLA | DUO | DUO | DUO | TRIO |
| DD1 ³ | + D1 | DD1 ³ + SD1 | | DD1 ³ | + DD1 | DMX + DMX | |
| DDA, DDA8 ³ | + DA | | | DDA, DDA8 ³ | + DDA, DDA8 | | |
| DMX | + DMX | | | DMX | + DMX | | |
| | | | | LD2 ³ | + LD2 | | |

³Not available with two 2" modules (2X2IN).

ADJUSTABLE MODULE

| SW/FS | SOLA | DUO |
|--------------|-----------------|-----------|
| D1, ELV, TRI | SD1, SELV, STRI | DD1 |
| DA | | DDA, DDA8 |
| LDE1 | | DMX |
| ELDO | | LD2 |
| ELD1 | | |

AMBIENT

| SW | SOLA | DUO | TRIO |
|-------------------|------|-----------|------|
| D1 | SD1 | DD1 | DMX |
| DA | | DDA, DDA8 | |
| LDE1 ⁴ | | DMX | |
| ELDO | | LD2 | |
| ELD1 | | | |

⁴Not available with 4 W.

HEMI L

DOWNLIGHT RECESSED



Color Quality

| COLOR QUALITY - 3500K | |
|-----------------------|------|
| TM-30 R _r | 90 |
| TM-30 R _g | 100 |
| CRI | 90 |
| R9 | > 50 |

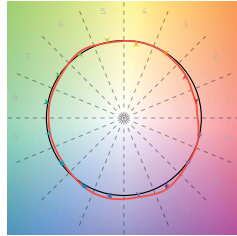

Photometrics

Values calculated based on 3500K and white baffle.

ADJUSTABLE MODULE - 3"

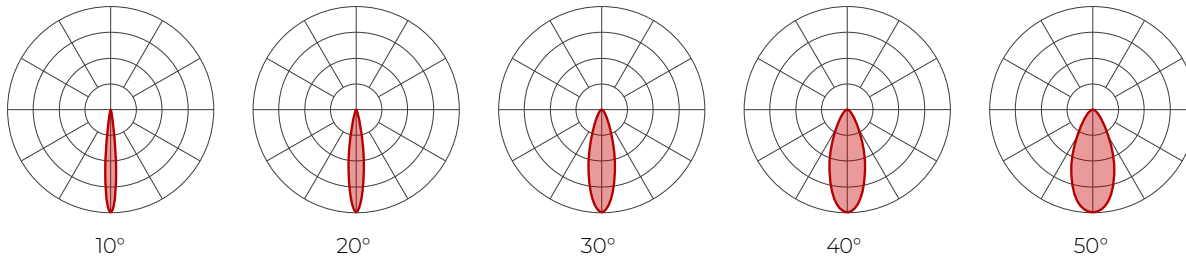

Delivered lumens

| CRI | 90 CRI | | | | | 95 CRI | | | | | 80 CRI | | | | |
|------|--------|------|------|------|------|--------|------|------|------|------|--------|------|------|------|------|
| | BEAM | 10° | 20° | 30° | 40° | 50° | 10° | 20° | 30° | 40° | 50° | 10° | 20° | 30° | 40° |
| 14 W | 1257 | 1203 | 1410 | 1424 | 1379 | 1137 | 1108 | 1277 | 1289 | 1248 | 1348 | 1294 | 1501 | 1532 | 1475 |
| 20 W | 1576 | 1508 | 1912 | 1933 | 1871 | 1426 | 1365 | 1731 | 1751 | 1694 | 1692 | 1623 | 2037 | 2078 | 1995 |

Efficacy

| CRI | 90 CRI | | | | | 95 CRI | | | | | 80 CRI | | | | |
|------|--------|-----|-----|-----|-----|--------|-----|-----|-----|-----|--------|-----|-----|-----|-----|
| | BEAM | 10° | 20° | 30° | 40° | 50° | 10° | 20° | 30° | 40° | 50° | 10° | 20° | 30° | 40° |
| 14 W | 90 | 86 | 101 | 102 | 99 | 81 | 79 | 91 | 92 | 89 | 96 | 92 | 107 | 109 | 105 |
| 20 W | 79 | 75 | 96 | 97 | 94 | 71 | 68 | 87 | 88 | 85 | 85 | 81 | 102 | 104 | 100 |

MULTIPLIERS

Please follow the multiplier tables to ensure correct lumen value.

Beams, CCT, dome colors, baffle colors, and accessories will change the lumen value.

| CCT | | FULL SPECTRUM | | OPTICAL OPTIONS | |
|-------|------|---------------|-----|-----------------|-------------------|
| 2700K | 0.9 | FS | 0.7 | Linear spread | 0.84 |
| 3000K | 0.95 | | | Hex louver | 0.86 |
| 3500K | 1 | | | Snoot | Variable Per Beam |
| 4000K | 1.05 | | | Half snoot | Variable Per Beam |

For SOLA and DUO, please consult factory.

HEMI L

DOWNLIGHT RECESSED



Color Quality

COLOR QUALITY - 3500K

| | |
|----------------------|------|
| TM-30 R _r | 91 |
| TM-30 R _g | 100 |
| CRI | 90 |
| R9 | > 50 |

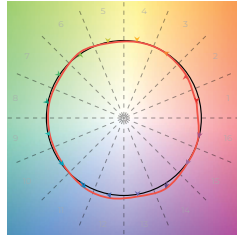

Photometrics

Values calculated based on 3500K and white baffle.

ADJUSTABLE MODULE - 2"

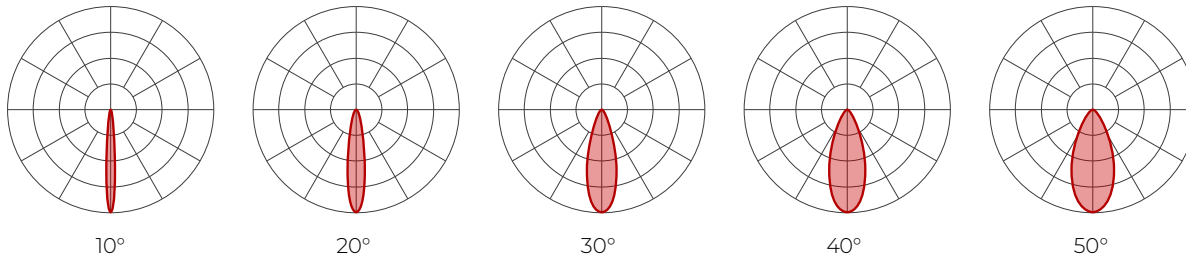

Delivered lumens

| CRI | 90 CRI | | | | | 95 CRI | | | | | 80 CRI | | | | |
|------|--------|-----|------|------|------|--------|-----|------|------|------|--------|-----|------|------|------|
| | 10° | 20° | 30° | 40° | 50° | 10° | 20° | 30° | 40° | 50° | 10° | 20° | 30° | 40° | 50° |
| 10 W | 641 | 630 | 1012 | 978 | 966 | 580 | 570 | 916 | 885 | 874 | 694 | 683 | 1103 | 1068 | 1057 |
| 14 W | 828 | 814 | 1228 | 1187 | 1173 | 749 | 737 | 1112 | 1075 | 1062 | 897 | 883 | 1338 | 1297 | 1283 |

Efficacy

| CRI | 90 CRI | | | | | 95 CRI | | | | | 80 CRI | | | | |
|------|--------|-----|-----|-----|-----|--------|-----|-----|-----|-----|--------|-----|-----|-----|-----|
| | 10° | 20° | 30° | 40° | 50° | 10° | 20° | 30° | 40° | 50° | 10° | 20° | 30° | 40° | 50° |
| 10 W | 64 | 63 | 101 | 98 | 97 | 58 | 57 | 92 | 89 | 87 | 69 | 68 | 110 | 107 | 106 |
| 14 W | 59 | 58 | 88 | 85 | 84 | 54 | 53 | 79 | 77 | 76 | 64 | 63 | 96 | 93 | 92 |

MULTIPLIERS

Please follow the multiplier tables to ensure correct lumen value.

Beams, CCT, dome colors, baffle colors, and accessories will change the lumen value.

| CCT | | FULL SPECTRUM | | OPTICAL OPTIONS | |
|-------|------|---------------|-----|-----------------|-------------------|
| 2700K | 0.9 | FS | 0.7 | Linear spread | 0.84 |
| 3000K | 0.95 | | | Hex louver | 0.86 |
| 3500K | 1 | | | Snoot | Variable Per Beam |
| 4000K | 1.05 | | | Half snoot | Variable Per Beam |

For SOLA and DUO, please consult factory.

HEMI L

DOWNLIGHT RECESSED



Color Quality

| COLOR QUALITY - 3500K | |
|-----------------------|------|
| TM-30 R _r | 91 |
| TM-30 R _g | 98.7 |
| CRI | 93.3 |
| R9 | > 50 |

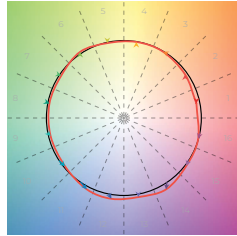

Photometrics

Values calculated based on 3500K and white dome.

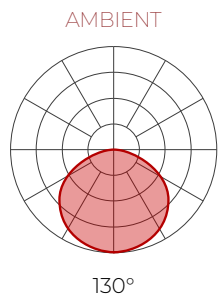

Delivered lumens

| CRI | 90 CRI | 95 CRI | 80 CRI |
|------|--------|--------|--------|
| 4 W | 150 | 157 | 176 |
| 10 W | 351 | 368 | 413 |
| 16 W | 536 | 561 | 630 |

Efficacy

| CRI | 90 CRI | 95 CRI | 80 CRI |
|------|--------|--------|--------|
| 4 W | 38 | 39 | 44 |
| 10 W | 35 | 37 | 41 |
| 16 W | 34 | 35 | 39 |

MULTIPLIERS

Please follow the multiplier tables to ensure correct lumen value.
CCT and adjustable module configuration will change the lumen value.

| CCT | | CONFIGURATION WITH ADJUSTABLE MODULE | | |
|-------|------|--------------------------------------|-------|------|
| 2700K | 0.9 | 3" module | White | 0.6 |
| 3000K | 0.95 | | Black | 0.6 |
| 3500K | 1 | 2" module | White | 0.89 |
| 4000K | 1.05 | | Black | 0.74 |
| | | 2 X 2" modules | White | 0.78 |
| | | | Black | 0.53 |

For SOLA and DUO, please consult factory.

*This is the light loss factor on the ambient portion of the light when there is a module as an obstruction. The multiplier is with the ambient light on, and the module light off.

Multiply together each applicable factor for CCT and adjustable module configuration to determine the final multiplier for the ambient light portion of your fixture.

CCT × Configuration with adjustable module = FINAL MULTIPLIER

HEMI L

DOWNLIGHT RECESSED



Technical Specifications

OPTIC

Adjustable Module

Hyflex™ optics provide precise optical control in a remarkably compact form. The core of this four-tier system is a compound reflector with a central TIR element, just 1.06" deep. Beam smoothing discs perfect beam angles up to 50°. Beam angles are easily interchanged in the field.

Ambient

Hemi can deliver soft ambient light with or without additional light modules. The ambient array can emit values up to 630 lumens and can be controlled separately or in conjunction with the light modules. You can use Trio to play with color and Sola or Duo to tune your white light.

LIGHT SOURCE

Adjustable Module

Compact COB (Chip-On-Board) LED module, available in 2700K, 3000K, 3500K and 4000K with a choice of 80 CRI, 90 CRI, or 95 CRI, with elevated R9 value for 90 CRI and above. Color consistency is maintained to within 2 SDCM. All LEDs have been tested in accordance with IESNA LM-80-08 and the results have shown L80 lumen maintenance greater than 60,000 hours. Absolute product photometry is measured and presented in accordance with IESNA LM-79, unless otherwise indicated. Optional full spectrum LEDs can be incorporated in the fixture to increase Cyanosis Observation Index (COI) and assist in regulating circadian rhythms.

Ambient

Custom linear array of mid-flux LEDs are cartridge-mounted with quick-connect wiring to facilitate service and thermal management. Available in 2700K, 3000K, 3500K and 4000K with a choice of 80 CRI, 90 CRI, or 95 CRI, with elevated R9 value for 90 CRI and above. Color consistency maintained to within 3 SDCM. LEDs operate at reduced drive current to optimize efficacy and lumen maintenance. All LEDs have been tested in accordance with IESNA LM-80-08 and the results have shown L80 lumen maintenance greater than 60,000 hours. Absolute product photometry is measured and presented in accordance with IESNA LM-79, unless otherwise indicated.

Chromawerx SOLA

Chromawerx SOLA is single-channel control that dims output while warming the color temperature in a pre-determined relationship. A simple analog control adjusts a specially populated LED array to emulate the effect of dimming a filament source.

Chromawerx DUO

Chromawerx DUO offers a two-channel control system which uses analog or digital protocols for synchronous control of both cool (6500K) to warm (2700K) LED arrays - maintaining a CRI above 90. The range of color DUO offers is useful for entraining circadian rhythms, stimulating alertness, and compensating for jet lag among other applications. The Chromawerx drivers are programmed to limit maximum light output and power usage across all color temperatures. When paired with DALI drivers (DDA/DDA8), color tuning follows a linear dimming curve.

Chromawerx TRIO

Chromawerx TRIO is our 3-channel control of an RGB (red-green-blue) array provided in the Soft Ambient of the HEMI S and HEMI L fixtures. TRIO addresses the need for more expressive color in architectural applications by using the DMX protocol to support dynamic multi-hued color. While a typical user interface will be a DMX controller by others, Lumenwerx offers a simple control station for stand-alone color changing applications.

ELECTRICAL

Unless otherwise specified, dimming down to 1%. At maximum driver load: efficiency>84%, PF>0.9, THD<20%.

Integral: 0-10V, ELV, TRIAC, Lutron Hi-Lume 1% EcoSystem, DALI, eldoLED 0.1% SOLOdrive 0-10V, eldoLED 1% ECOdrive 0-10V, DMX, Lutron DALI-2 digital

PoE

Depending on the PoE manufacturer selected, Lumenwerx will install the node in factory as either integral to the luminaire or as a remote module. Factory programming of the PoE node may or may not enable the following functionalities: lumen package, DUO (tunable white), QUADRO (RGBW), emergency battery backup, and sensor integration. These must be addressed and evaluated on a case-by-case basis.

HEMI L

DOWNLIGHT RECESSED



CONSTRUCTION

Housing

For new construction, 22 gauge galvanized steel, open frame, non-IC rated. 18 gauge galvanized steel junction box with ½" trade size knockouts. Adjustable hanger bars and butterfly brackets are included. Adjustable commercial hat channel and flush mounted brackets are also available.

Light element

Adjustability: Hot aiming, 355° rotation and up to 40° vertical tilt with shift to ensure beam stays centered.

LED module: Integral COB module. 90 CRI and 2 SDCM, Standard with options of 80 CRI, or 95 CRI. L80 > 60,000 hours.

HyFlex™ optics: Proprietary TIR/reflector with field interchangeable beam smoothing lenses.

Thermal management: Die casted aluminum heat sink and efficient thermal padding to maximize dissipation.

Trim: Die-cast aluminum mounted with retaining spring clips

Trim style: Trimmed and trimless with mudplate or millwork adapter

WEIGHT

Open frame: 6.2 lbs - 2.8 kg

Remodel: 3.1 lbs - 1.4 kg

BEAM ANGLES

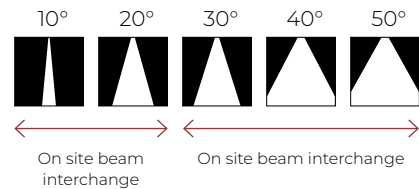

OPTICAL OPTIONS



ENVIRONMENT

Ambient temperature at fixture location shall be within 0°C/32°F - 25°C/77°F, indoor dry or damp as well as outdoor damp use (canopies or marquees).

CERTIFICATION

ETL: Rated for Indoor dry/damp locations. Conforms to UL Standard 1598 and certified to CAN/CSA Standard C22.2 No. 250.0.

WARRANTY

Lumenwerx provides a five-year limited warranty on electrical and mechanical performance of the luminaires, including the LED boards, drivers, and auxiliary electronics. Lumenwerx will repair or replace defective luminaires or components at our discretion, provided they have been installed and operated in accordance with our specifications. Other limitations apply, please refer to the full warranty on our website.