

MINEAR RING

Pendant - Remote Driver Box (RDB) - Multiple Canopies





INSTALLATION INSTRUCTIONS

 This product must be installed in accordance with the National Electrical Code and all applicable local codes, by a person familiar with the construction and operation of the product, and the hazards involved. Proper grounding is required for safety.

Ce produit doit être installé suivant le code national de l'électricité, ainsi que tous les codes locaux applicables, par une personne familière avec la construction et le fonctionnement du produit, ainsi que tous les risques qui y sont associés. La mise à terre électrique est obligatoire pour la sécurité.

 Disconnect power before installation or servicing.

 Do not cover the light element lens or heatsink with any materials or adhesive tapes when the fixture is powered.

 Handle the LED cartridge carefully during removal and installation. Tools must not touch the LED chips. Contact may result in damage and LED failure.

 Wire dimming conductors as Class 1.

 A luminaire with more than one power supply connection means shall be connected to only one branch circuit.

 For luminaires specified as recessed, clearance between the sides of the luminaire and parts of the building must be 1/2" minimum; clearance to insulating materials to be 3" minimum, unless luminaire is IC rated.

 For luminaires installed in wet locations, properly seal all mounting and electrical points.

 Warranty claims will not be accepted if incorrect driver or light element is used.

MINEAR RING

Pendant - Remote Driver Box (RDB) - Multiple Canopies



INSTALLATION INSTRUCTIONS

POC POWER-OVER-AIRCRAFT CABLE

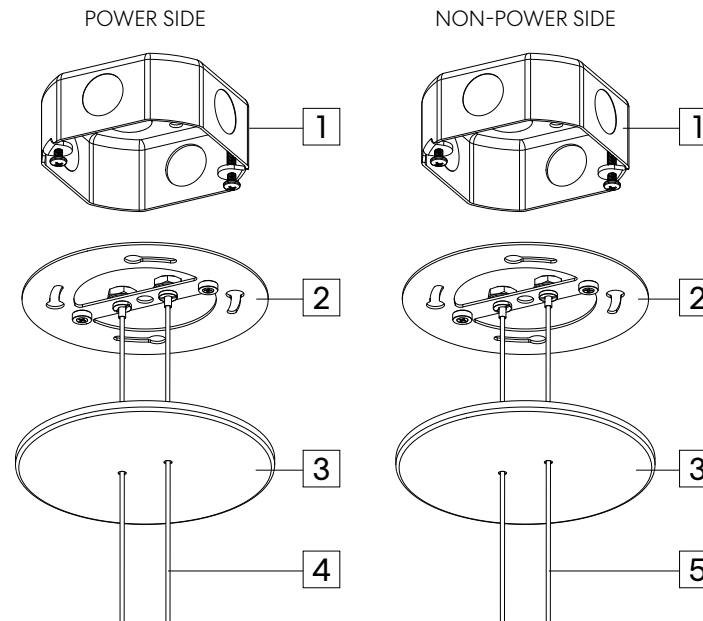

For electrical connections, please refer to the [wiring diagram guide](#).



For remote driver box installation instructions, please refer to the [remote driver installation sheet](#).



INDEX

Power side.....	P3
Non-power side.....	P4

ITEMS LIST

1	Standard J-box (by others)
2	Mounting plate
3	Flat round canopy
4	Power-over-aircraft cable
5	Aircraft cable

TOOLS REQUIRED

- Phillips screwdriver
- Aircraft cable cutter
- Scissors



MINEAR RING

Pendant - Remote Driver Box (RDB) - Multiple Canopies



POC (POWER-OVER-AIRCRAFT CABLE)

POWER SIDE

1 INSTALL AIRCRAFT CABLES.

Install and reinforce J-box to ceiling structure. Separate the canopy [A] from the mounting plate [B].

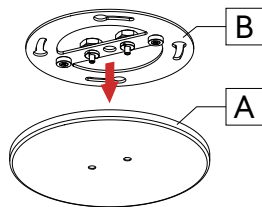

Pass the aircraft cables [C] through the canopy [A]. Insert them into the griplocks [D] then adjust the cables [C] by pushing the feeder tube [D].

Note: Make sure to have a steady hold of the fixture. It should never hang loosely from the POC (power-over-aircraft cable) if the installation is not complete.

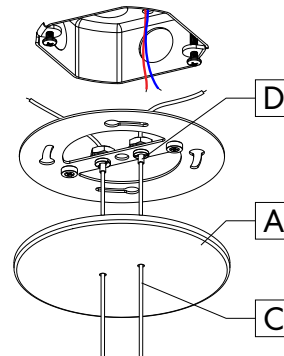

Pull the aircraft cables [C] and remote driver feed [E] out through the mounting plate [B] to make easy electrical connections.

Note: Height adjustment of the fixture must be done at this step.

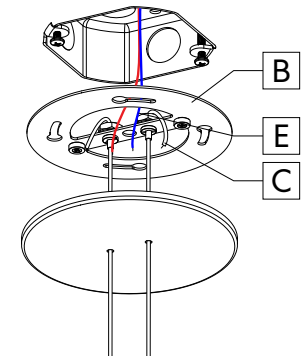

2 FIX MOUNTING PLATE TO CEILING.

Mount and turn the mounting plate [B] to place on the junction box [F].

Tighten screws [G] to secure the mounting plate [B] to the junction box.

Cut the excess cables with an aircraft cable cutter [H].

Note: Leave POC length of 1.5" to make the connection inside the junction box.

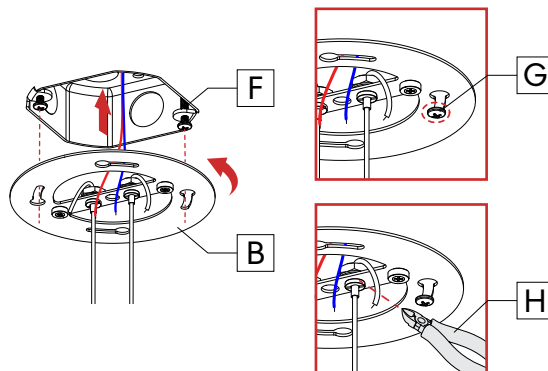

3 MAKE ELECTRICAL CONNECTIONS.

Make electrical connections between POC (power-over-aircraft cable) [C] and the remote driver feed [E].

Note: Make sure that you are connecting the negative (-) POC (as marked on the fixture with blue color and a label) to your negative wire and the positive (+) POC (as marked on the fixture with red color and a label) to your positive wire.

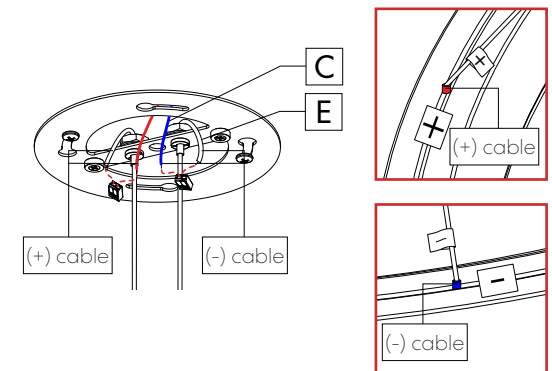

MINEAR RING

Pendant - Remote Driver Box (RDB) - Multiple Canopies



POC (POWER-OVER-AIRCRAFT CABLE)

4 REINSTALL CANOPY.

Push all cables in the junction box, and put the canopy [A] back in place.

Cut the labels [I] off the wires.

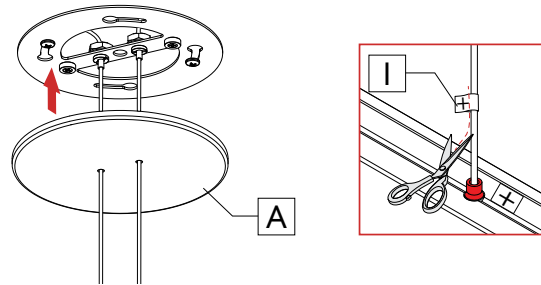

NON-POWER SIDE

1 INSTALL AIRCRAFT CABLES.

Separate the canopy [J] from the mounting plate [K].

Pass the aircraft cables [L] through the canopy [J]. Insert them into the griplocks [M] then adjust the cables [L] by pushing the feeder tube [M].

Cut the excess cables with an aircraft cable cutter [H].

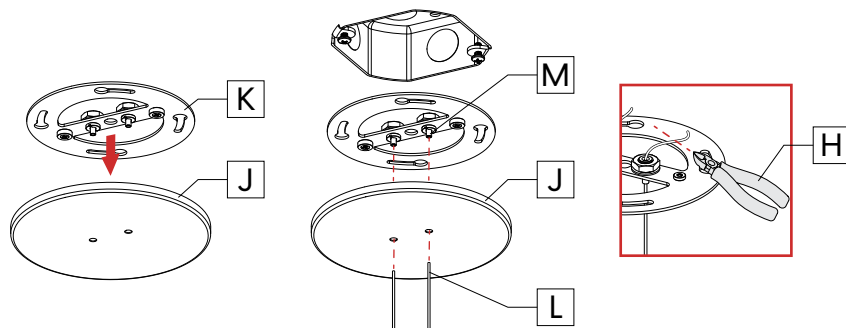

2 FIX MOUNTING PLATE AND CANOPY TO CEILING.

Mount and turn the mounting plate [K] to place on the junction box [N].

Put the canopy [J] back in place.

Tighten screws [O] to secure the mounting plate [K] to the junction box.

