

# MINI PIVOT LINEAR

## Recessed - Drywall Mud Flange



 This product must be installed in accordance with the National Electrical Code and all applicable local codes, by a person familiar with the construction and operation of the product, and the hazards involved. Proper grounding is required for safety.

Ce produit doit être installé suivant le code national de l'électricité, ainsi que tous les codes locaux applicables, par une personne familière avec la construction et le fonctionnement du produit, ainsi que tous les risques qui y sont associés. La mise à terre électrique est obligatoire pour la sécurité.

 Wire dimming conductors as Class 1.

 For electrical connections, please refer to the [wiring diagram guide](#).



### SINGLE FIXTURE

 For remote driver box, please refer to the [remote driver installation sheet](#) for more information.

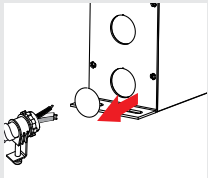

#### 1 PREPARE CEILING OPENING.

**Caution:** Make sure the electrical power is turned off.

Prepare the area where the fixture is going to be installed. Cut hole in the drywall according to the dimensions [\*] given in the client drawings.

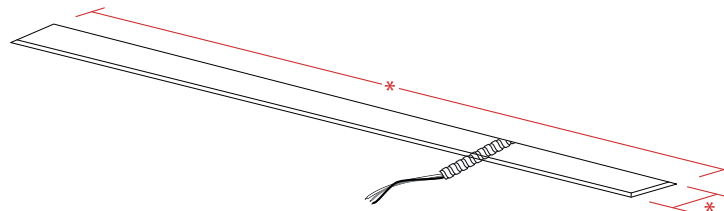

#### 2 PREPARE FIXTURE.

Make sure the lens is installed on the fixture [A] and protected by a cover. The temporary brackets [B] should be aligned with the obround holes of the flanges.

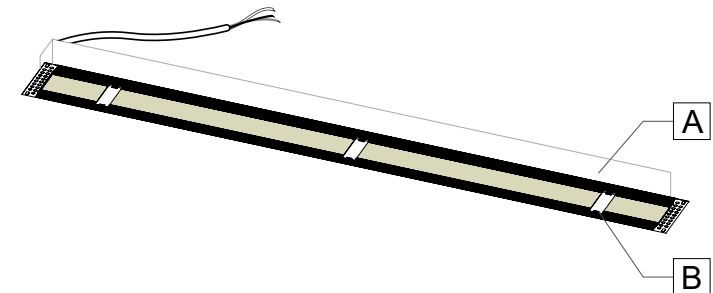

#### 3 MAKE ELECTRICAL CONNECTIONS.

Unfasten the screw and pivot the J-box cover [C]. Pass the main power cable [D] (by others) through the cable connector [E] (by others), and install onto the J-box [F].

Make electrical connections between the main power cable [D] and fixture cable [F] using wire nuts [G] (by others). Close the J-box cover [C].

**Note:** Number of wires may vary.

**Warning:** A luminaire with more than one power supply connection means shall be connected to only one branch circuit.

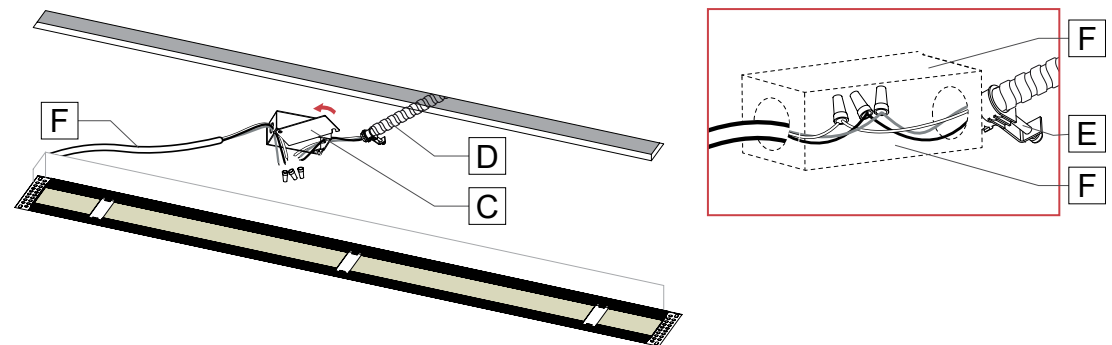

# MINI PIVOT LINEAR

## Recessed - Drywall Mud Flange

### 4 INSTALL FIXTURE.

Insert the fixture [A] and the J-box [F] into the pre-cut hole in the drywall and fasten drywall screws [G] through the obround holes of the flanges [H].

To reinforce the drywall screws [G], wood blocking [I] or drywall anchors [J] must be used.

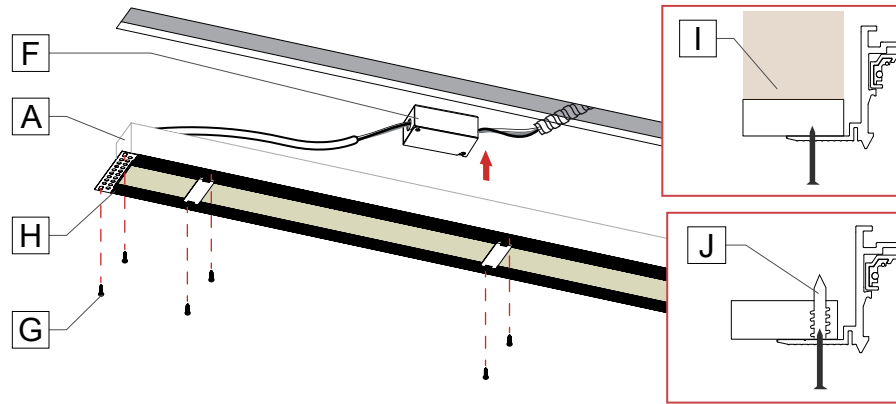

### 5 ADJUST FIXTURE IN PLACE.

If the fixture position needs adjustments, remove screws [G] on one side of the fixture [A] and adjust it. Reinstall the screws once the position is settled.

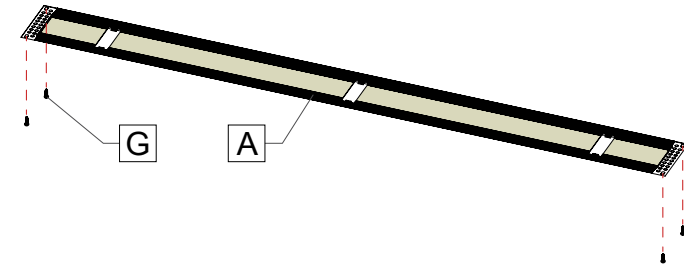

### 6 REMOVE TEMPORARY BRACKETS.

Once the fixture is attached to the ceiling, remove the temporary brackets [B].

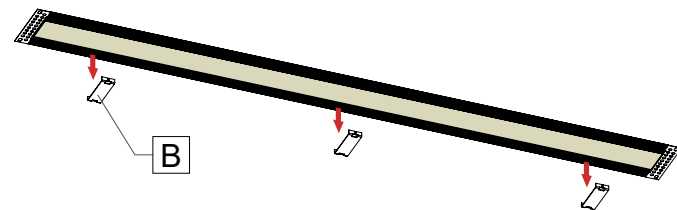

### 7 FINISH INSTALLATION.

Plaster and sand over mud flange [K] to create a smooth finish.

Once the mud is totally dry and painted, gently remove the cover [L].



# MINI PIVOT LINEAR

## Recessed - Drywall Mud Flange

### CONTINUOUS RUN

**1** FOR A CONTINUOUS RUN, FOLLOW STEPS **1-4** FROM THE SINGLE FIXTURE INSTRUCTIONS FOR THE FIRST FIXTURE IN THE RUN, THEN:

**2** MAKE ELECTRICAL CONNECTIONS.

Make the wire connections between the first two fixtures **[A]** and **[M]** using quick connectors **[N]**. Push wires inside the fixture.

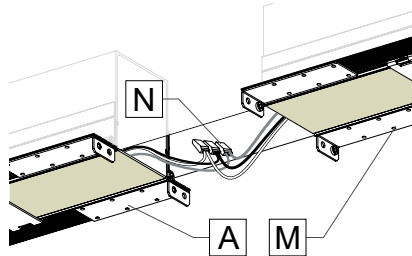

Insert the second fixture **[M]** into the drywall hole.

**Note:** Number of wires may vary.

**3** ATTACH FIXTURES.

Slide the second fixture **[M]** to the first fixture **[A]**. Attach the two fixtures by fastening screws on the joiners **[O]**.

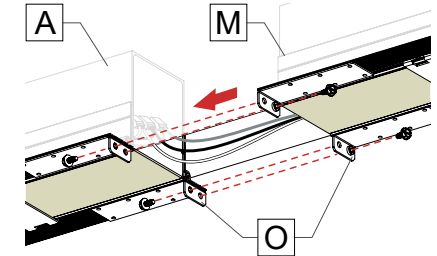
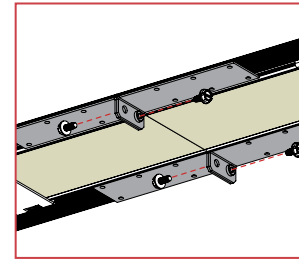

**4** FIX FIXTURE TO DRYWALL CEILING.

Fasten drywall screws **[G]** through the obround holes of the flanges **[H]**.

To reinforce the drywall screws **[G]**, wood blocking **[I]** or drywall anchors **[J]** must be used.

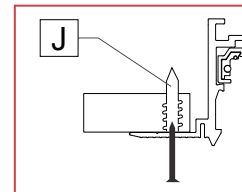
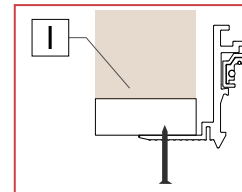
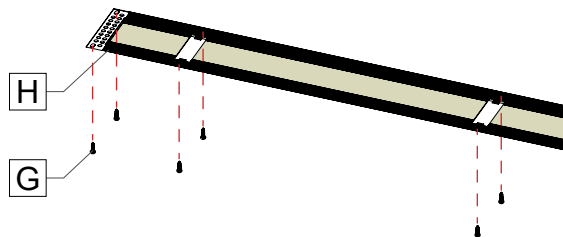

**5** REPEAT THE STEPS **2-4** FOR ALL OTHER FIXTURES IN THE RUN.

# MINI PIVOT LINEAR

## Recessed - Drywall Mud Flange

### 6 REMOVE TEMPORARY BRACKETS.

Once the fixture is attached to the ceiling, remove the temporary brackets **[B]** and the joiners **[O]**.

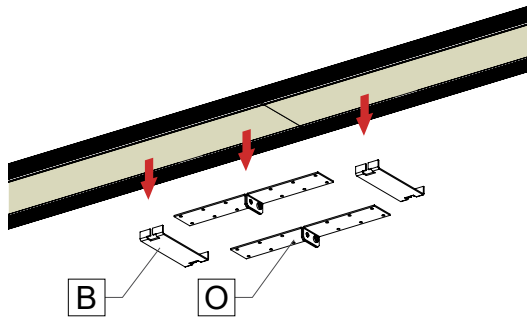

### 7 FINISH INSTALLATION.

Plaster and sand over mud flange **[K]** to create a smooth finish.

Once the mud is totally dry and painted, gently remove the cover **[L]**.

