

PETITE 1" MULTI-APERTURE

ROUND RECESSED ADJUSTABLE

NEW CONSTRUCTION



1 X 3
Adjustable Cut Cone
Flanged Trim

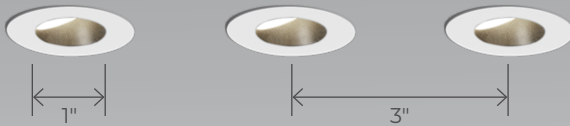

1 X 2
Adjustable
Trimless

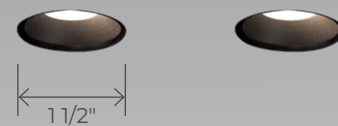

The Petite family strikes that perfect balance of compact size, streamlined aesthetics, and high performance. Through their 1" lens apertures, these meticulously engineered downlight, cylinder, and multi-aperture luminaires breathe light into spaces with a quiet, straightforward sophistication.

Array



Beam Angles



Light Source



Ceiling Types



Plenum Clearance

As low as 2 1/8"



Petite Family (Refer to other spec sheets)

Downlight



Adjustable Recessed Wall Wash

Multi-aperture



Adjustable Recessed Wall Wash

Cylinder



Pendant Surface

PETITE 1" MULTI-APERTURE

ROUND RECESSED ADJUSTABLE

NEW CONSTRUCTION



Project: _____

Type: _____

Order Guide

LUMINAIRE ID ¹		ARRAY	TRIM STYLE	BAFFLE FINISH Specify NA for Glow ring	TRIM FLANGE FINISH Specify NA for Glow ring and Trimless	
<p><u>UP TO 15°</u> PETIMRRA15 ² - Petite 1" Multi-aperture Round Recessed Adjustable</p> <p><u>UP TO 30°</u> PETIMRRA30 ³ - Petite 1" Multi-aperture Round Recessed Adjustable Cut Cone</p> <p>¹ Recessed (fixed) and Recessed Wall Wash also available. Consult other spec sheets. ² Adjustability: Up to 15° tilt, 355° rotation. ³ Adjustability: Up to 30° tilt, 355° rotation.</p>		<p>1X2M - 1 X 2 1X3M - 1 X 3</p>	<p>PETIRRA15 Adjustable</p> <p>TRM - Flanged trim TRMP - Flush flanged trim drywall mudplate TRMW - Flush flanged trim millwork</p> <p>TLMP - Trimless drywall mudplate TLMW - Trimless millwork</p> <p>GLR - Glow ring</p>	<p>PETIRRA30 Adjustable Cut Cone</p> <p>TRMC - Flanged trim cut cone TRMPC - Flush flanged trim drywall mudplate cut cone TRMWC - Flush flanged trim millwork cut cone</p>	<p>FTMW - Matte white FTMB - Matte black FSPC - Satin silver FSSPC - Matte silver FCHP - Champagne FDBZ - Dark bronze FPF - Primer finish CF# - Custom finish, specify RAL# NA - Not applicable</p>	<p>FTMW - Matte white FTMB - Matte black FSPC - Satin silver FSSPC - Matte silver FCHP - Champagne FDBZ - Dark bronze FPF - Primer finish CF# - Custom finish, specify RAL# NA - Not applicable</p>
LENS	CEILING THICKNESS	INSTALLATION TYPE ⁵	MOUNTING OPTION ⁷	LIGHT SOURCE	BEAM	
	11N					
<p>At baffle</p> <p>SDL ⁴ - Soft diffused lens, Solite NOL - No lens</p> <p>⁴ Only available with 35° and 45° in static white.</p>	11N - Up to 1"	<p>IC ⁶ - Type-IC NIC ⁶ - Type Non-IC CP ⁶ - Chicago Plenum Type-IC (CCEA)</p> <p>⁵ See page 3 for more details. ⁶ See Wattage section for limitations.</p>	<p>ASB - Adjustable standard bar hangers FMB - Flush mount bars ACB - Adjustable commercial bar hangers AHC - Adjustable hat channel bars NA - No bar hangers</p> <p>⁷ See page 4 for more details.</p>	<p>SW - Static white</p> <p>SOLA - Dim-to-warm single channel control DUO - Tunable white 2-channel control</p>	<p>35DEG - 35° Narrow flood 45DEG - 45° Flood 60DEG ⁸ - 60° Wide flood</p> <p>⁸ Only available with TLMP and TLMW trim options. ⁹ Only available with TRM, TRMP, and TRMW trim options.</p> <p>45DEG ⁹ - 45° Flood 60DEG ⁸ - 60° Very wide flood</p>	
COLOR QUALITY	CRI	COLOR TEMP.	DRIVER ¹¹	VOLTAGE	WATTAGE PER LIGHT	DIMMING ¹⁸
<p>2STP - 2 Step MacAdam Ellipse 3STP - 3 Step MacAdam Ellipse</p>	<p>80CRI - 80+ CRI 90CRI - 90+ CRI 95CRI - 95+ CRI</p>	<p>24K ¹⁰ - 2400K 27K - 2700K 30K - 3000K 35K - 3500K 40K - 4000K 50K ¹⁰ - 5000K</p> <p>¹⁰ Not available with 95+ CRI</p>	<p>INTEGRAL ¹²</p> <p>¹¹ A driver provided per light. ¹² Access above the ceiling is required. ¹³ A remote driver box is provided.</p>	<p>120V - 120V 277V - 277V UNV - 120V-277V</p>	<p>7W ^{14, 15} - 7 W output, up to 505 lm 10W ^{16, 17} - 10 W output, up to 667 lm</p> <p>¹⁴ Not available with 1 X 3 array when specified with IC/CP. ¹⁵ Not available with 1 X 3 array when specified with NIC and UNV. ¹⁶ Not available with 1 X 3 array or UNV. ¹⁷ Not available with IC/CP.</p>	<p>D1 - 1% 0-10V ELV ¹⁹ - ELV 120V TRI ¹⁹ - TRIAC 120V ELD1 - eldoLED 1% ECOdrive 0-10V ELD0 - eldoLED 0.1% SOLOdrive 0-10V PEQ0 ²⁰ - Lutron Hi-lume Premier 0.1% EcoSystem</p> <p>¹⁸ PoE (Power-over-Ethernet) compatible. Consult factory for details. ¹⁹ Available with 120V only. ²⁰ On-site commissioning is required.</p>
<p>3STP - 3 Step MacAdam Ellipse</p>	<p>90CRI - 90+ CRI</p>	<p>SOLA 30K18K - 3000K to 1800K 27K18K - 2700K to 1800K</p> <p>DUO 65K27K - 6500K to 2700K 50K27K - 5000K to 2700K</p>			<p>SOLA 10W ^{16, 17} - 10 W output, up to 324 lm</p>	<p>SOLA SD1 - Single 0-10V input SELV ¹⁹ - ELV 120V STR1 ¹⁹ - TRIAC 120V</p>
			REMOTE ¹³	DO NOT SPECIFY FOR REMOTE. SEE "REMOTE DRIVER BOX" SECTION BELOW.		

Remote Driver Box

Ordered separately. Specify each required remote driver box on a separate line. ←

REMOTE DRIVER ²¹	LUMINAIRE QTY. ²²	LUMINAIRE ID	VOLTAGE	WATTAGE PER LIGHT	DIMMING	
<p>RDB# - Remote driver box</p> <p>²¹ Specify an RDB number (#) for each required remote driver box.</p>	<p>2X ²³ - 2 luminaires 3X ²⁴ - 3 luminaires</p> <p>²² Each luminaire requires its own driver. Specify the number of luminaires per driver box. ²³ Only available with 1 X 2 array. ²⁴ Only available with 1 X 3 array.</p>	<p><u>UP TO 15°</u> PETIMRRA15 ²⁵ - Petite 1" Multi-aperture Round Recessed Adjustable</p> <p><u>UP TO 30°</u> PETIMRRA30 ²⁶ - Petite 1" Multi-aperture Round Recessed Adjustable Cut Cone</p> <p>²⁵ Adjustability: Up to 15° tilt, 355° rotation. ²⁶ Adjustability: Up to 30° tilt, 355° rotation.</p>	<p>120V - 120V 277V - 277V UNV - 120V-277V 347V ²⁷ - 347V</p> <p>²⁷ Available with RD1 driver only. Please consult factory.</p>	<p>7W ^{28, 29} - 7 W output, up to 505 lm 10W ^{30, 31} - 10 W output, up to 667 lm</p> <p>²⁸ Not available with 1 X 3 array when specified with IC/CP. ²⁹ Not available with 1 X 3 array when specified with NIC and UNV. ³⁰ Not available with 1 X 3 array or UNV. ³¹ Not available with IC/CP.</p>	<p>RD1 - 1% 0-10V RELV ³² - ELV 120V RTRI ³² - TRIAC 120V RLDE1 ³³ - Lutron Hi-lume 1% Eco RDA ³³ - DALI RELD1 - eldoLED 1% ECOdrive 0-10V</p> <p>³² Available with 120V only. ³³ On-site commissioning is required. ³⁴ To specify, add +EB to the selected dimming option, e.g. RD1+EB.</p>	
			<p>SOLA 10W ^{30, 31} - 10 W output, up to 324 lm</p> <p>DUO 7W ^{29, 31} - 7 W output, up to 241 lm</p>	<p>SOLA RSDI - Single 0-10V input RSELV ³² - ELV 120V RSTR1 ³² - TRIAC 120V</p>	<p>DUO RDMX ³³ - DMX RDDA ³³ - DALI DT6 RDDA8 ³³ - DALI DT8</p> <p>RDD1 - Dual 0-10V input for CCT/intensity RLD2 ³³ - Lutron DALI-2 digital</p>	
EXAMPLE CODE:	LIGHT	PETIMRRA15-1X2M-TRM-FTMW-FTMW-SDL-11N-IC-ASB-SW-35DEG-2STP-90CRI-35K-REMOTE			REMOTE DRIVER	RDB1-2X-PETIMRRA15-120V-7W-RD1



PETITE 1" MULTI-APERTURE

ROUND RECESSED ADJUSTABLE

NEW CONSTRUCTION



Installation Types

IC - Type-IC / NIC - Type Non-IC / CP - Chicago Plenum Type-IC (CCEA)		
INTEGRAL	1X2M - 1 X 2 	1X3M - 1 X 3
REMOTE	1X2M - 1 X 2 	1X3M - 1 X 3

- For integral, access above the ceiling is required.
 - For dimension B, see the PLENUM CLEARANCE table below.

PLENUM CLEARANCE

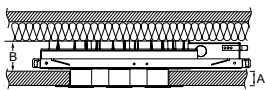

IC/CP - Insulated ceiling

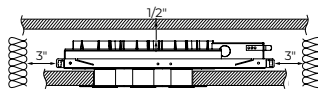

NIC* - Non-insulated ceiling
 * No insulation within 3" of the fixture.

CUT-OUT DIMENSIONS

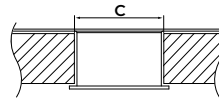

TRM - TRMP - TLMP - GLR
 TRMC - TRMPC

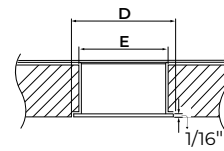

TRMW
 TRMWC

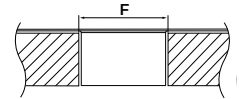

TLMW

PLENUM CLEARANCE HEIGHT AND CEILING THICKNESS			
		IC/CP	NIC
A	Ceiling thickness	1IN	1IN
B	Integral Remote	2 1/8" (FMB) 4" (ASB, ACB, AHC)	2 5/8" (FMB) 4" (ASB, ACB, AHC)

	PETIMRRA15 Adjustable	PETIMRRA30 Adjustable Cut Cone	CUT-OUT DIMENSIONS		
			Drywall	Acoustic Tile	Millwork
C	TRM	TRMC	∅ 111/16"		N/A
	TRMP / TLMP	TRMPC	∅ 111/16"		N/A
	GLR	NA	∅ 111/16"		
D					∅ 113/16"
E	TRMW	TRMWC	N/A		
F	TLMW	NA	N/A		∅ 111/16"

PETITE 1" MULTI-APERTURE

ROUND RECESSED ADJUSTABLE
NEW CONSTRUCTION



Mounting Options

ASB - Adjustable Standard Bar Hangers

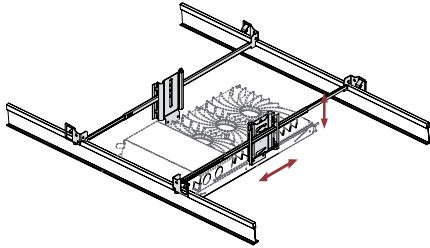

Adjustable Standard Bar hangers can be used in both commercial and residential applications and are adjustable to various heights in both Grid Ceiling and Drywall mounting. ASB hangers are less rigid and versatile than ACB hangers.

FMB - Flush Mount Bars

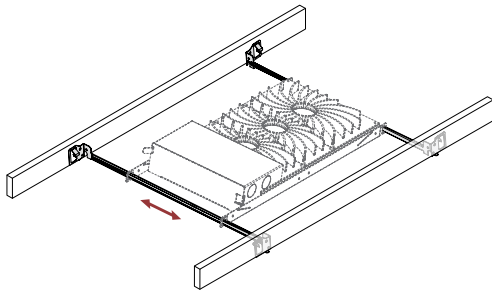

Flush Mount Bars are best used in residential applications, fitting snug to the surface and suitable for Wood, Metal, and Drywall mounting. The flush mounted bars are static and can't be adjusted.

ACB - Adjustable Commercial Bar Hangers

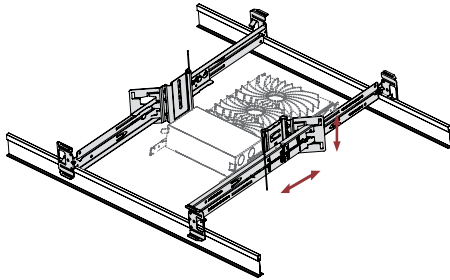

Adjustable Commercial Bar hangers can be used in both commercial and residential applications and are by far the most versatile mounting bar we offer with its adjustability to various heights. ACB hangers are suitable for Grid Ceiling, Drywall, Metal, Wood and Frame mounting.

- Extremely rigid
- Fits into C-Channel notches in a Butterfly Bracket

AHC - Adjustable Hat Channel Bars

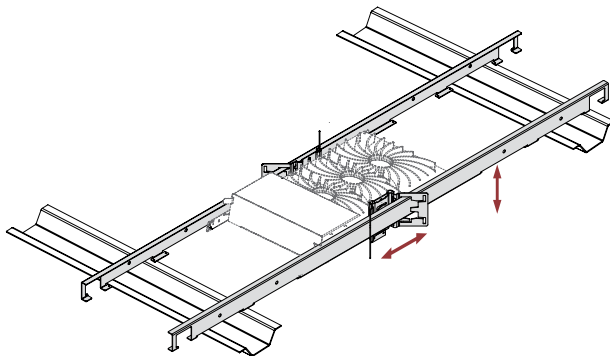

Adjustable Hat Channel bars can be used in both commercial and residential applications and come with a butterfly clip to adjust to various heights. AHC bars can be hung downward by 90 degrees in vertical position, and once wired, can be shifted onto the horizontal mounting plane. AHC bars are suitable for both Drywall and wood ceiling applications.

PETITE 1" MULTI-APERTURE

ROUND RECESSED ADJUSTABLE

NEW CONSTRUCTION



Trim Style

RECESSED ADJUSTABLE

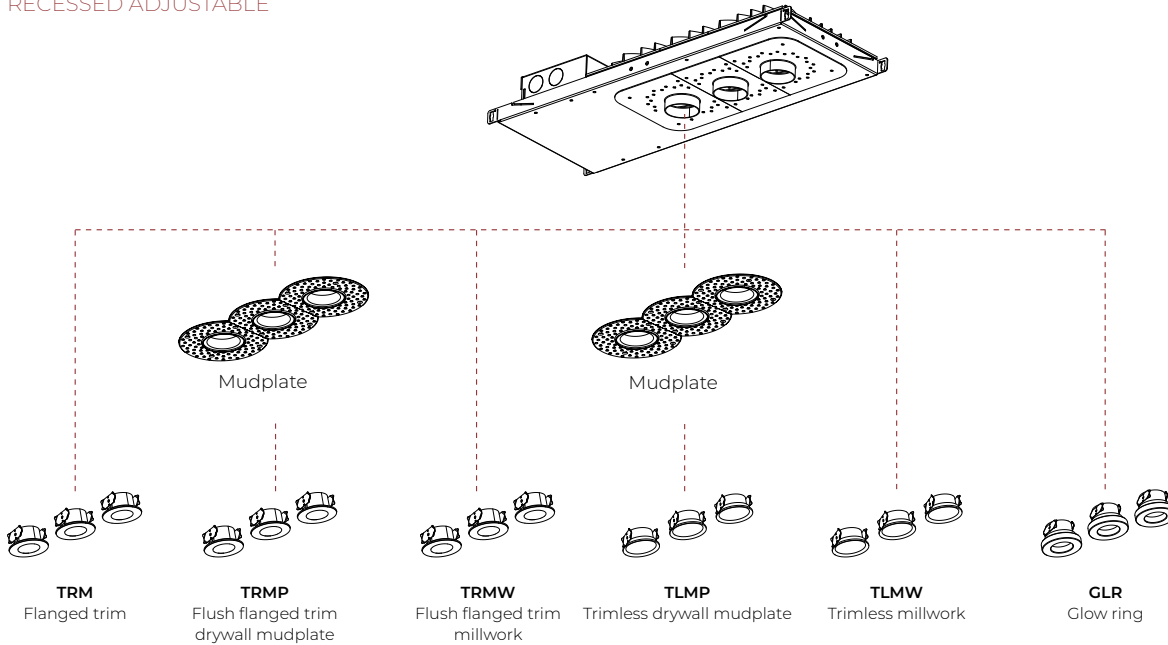

Lens

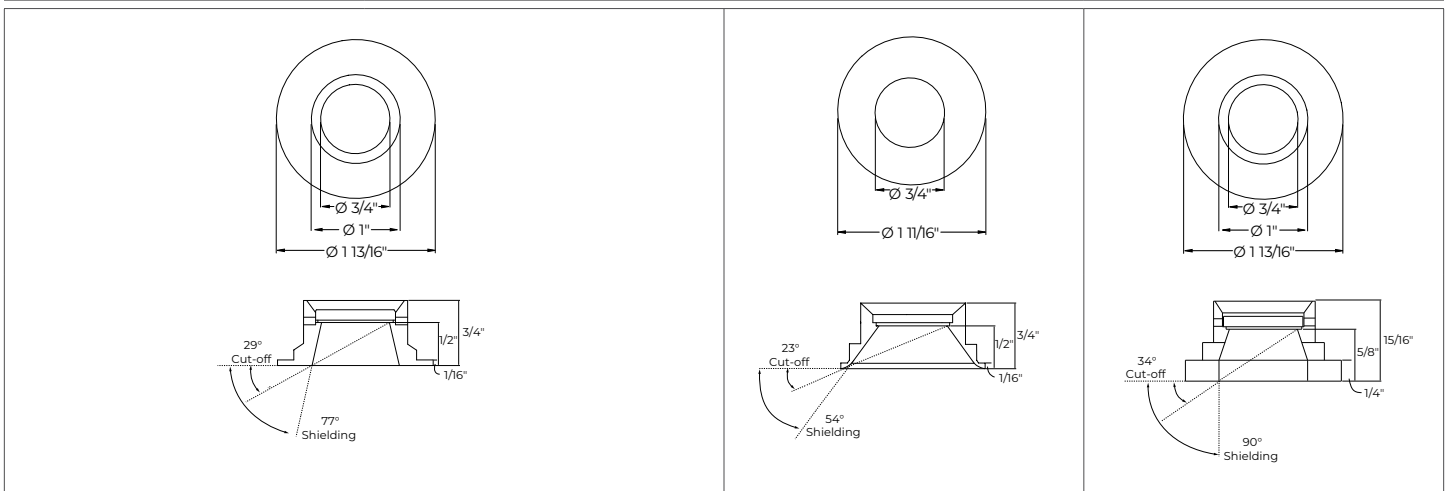
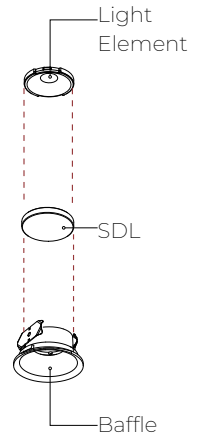

PETITE 1" MULTI-APERTURE

ROUND RECESSED ADJUSTABLE

NEW CONSTRUCTION



Trim Style

RECESSED ADJUSTABLE CUT CONE

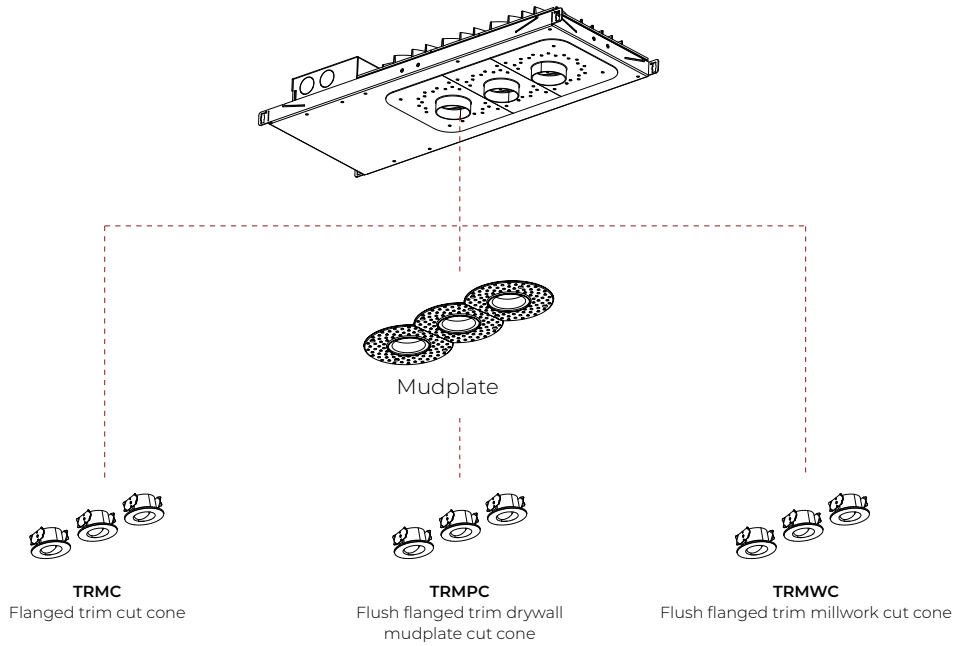

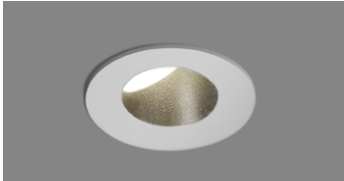
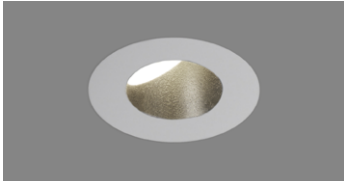
TRMC Flanged Trim Cut Cone	TRMPC / TRMWC Flush Flanged Trim Cut Cone
	

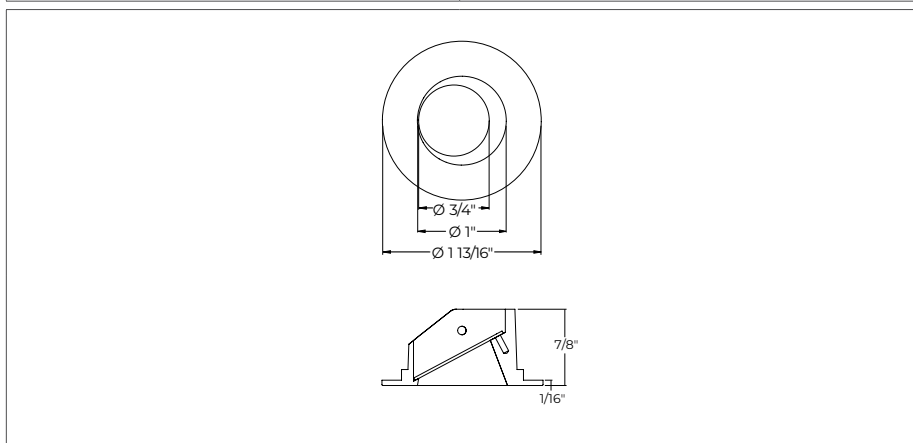

PETITE 1" MULTI-APERTURE

ROUND RECESSED ADJUSTABLE

NEW CONSTRUCTION



Color Quality

COLOR QUALITY - 3500K	
TM-30 Rr	91
TM-30 Ra	100
CRI	90+
R9	> 50

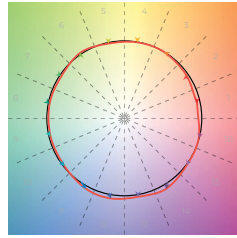

Photometrics

STATIC WHITE - ADJUSTABLE

Values calculated based on 3500K, 90+ CRI, and with no lens. The light distribution will vary depending on baffle finish and trim style. All values are per light.

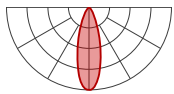

35DEG - 35° Narrow flood

WATTAGE		7 W		10 W	
Trim style	Baffle finish	lm	lm/W	lm	lm/W
Trim	White	425	61	529	53
	Black, Champagne, Dark bronze	327	47	432	43
	Satin silver, Matte silver	382	55	505	50
Trimless	White	449	64	592	59
	Black, Champagne, Dark bronze	413	59	545	55
	Satin silver, Matte silver	283	40	589	59
Glow ring		406	58	535	53

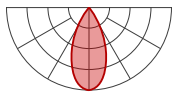

45DEG - 45° Flood

WATTAGE		7 W		10 W	
Trim style	Baffle finish	lm	lm/W	lm	lm/W
Trim	White	425	61	561	56
	Black, Champagne, Dark bronze	344	49	454	45
	Satin silver, Matte silver	407	58	538	54
Trimless	White	505	72	667	67
	Black, Champagne, Dark bronze	436	62	575	57
	Satin silver, Matte silver	481	69	634	63
Glow ring		408	58	539	54

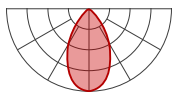

60DEG - 60° Wide flood

WATTAGE		7 W		10 W	
Trim style	Baffle finish	lm	lm/W	lm	lm/W
Trimless	White	318	45	419	42
	Black, Champagne, Dark bronze	247	35	326	33
	Satin silver, Matte silver	283	40	373	37

MULTIPLIERS

Please follow the multiplier tables to ensure correct lumen value. CCT, CRI, and lensing will change the lumen value.

CCT		CRI		LENS	
2400K	0.87	80+ CRI	1	SDL-Soft diffused lens, Solite	0.91
2700K	0.94	90+ CRI	1	No lens	1
3000K	0.98	95+ CRI	0.77		
3500K	1				
4000K	1.05				
5000K	1.05				

PETITE 1" MULTI-APERTURE

ROUND RECESSED ADJUSTABLE

NEW CONSTRUCTION



Photometrics

SOLA/DUO - ADJUSTABLE

Values calculated based on with no lens. The light distribution will vary depending on baffle finish and trim style. All values are per light.

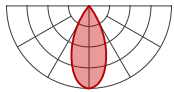

45DEG - 45° Flood

SOLA

WATTAGE			10 W	
CCT	Trim style	Baffle finish	lm	lm/W
3000K	Trim	White	273	27
		Black, Champagne, Dark bronze	221	22
		Satin silver, Matte silver	262	26
2700K	Trim	White	273	27
		Black, Champagne, Dark bronze	221	22
		Satin silver, Matte silver	262	26

DUO

WATTAGE			7 W	
CCT	Trim style	Baffle finish	lm	lm/W
6000K	Trim	White	160	23
		Black, Champagne, Dark bronze	125	18
		Satin silver, Matte silver	140	20
5000K	Trim	White	160	23
		Black, Champagne, Dark bronze	125	18
		Satin silver, Matte silver	140	20
2700K	Trim	White	140	20
		Black, Champagne, Dark bronze	109	16
		Satin silver, Matte silver	122	17

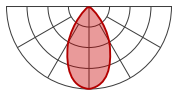

60DEG - 60° Wide flood

SOLA

WATTAGE			10 W	
CCT	Trim style	Baffle finish	lm	lm/W
3000K	Trimless	White	324	32
		Black, Champagne, Dark bronze	262	26
		Satin silver, Matte silver	310	31
2700K	Trimless	White	324	32
		Black, Champagne, Dark bronze	262	26
		Satin silver, Matte silver	310	31

DUO

WATTAGE			7 W	
CCT	Trim style	Baffle finish	lm	lm/W
6000K	Trimless	White	190	27
		Black, Champagne, Dark bronze	148	21
		Satin silver, Matte silver	166	24
5000K	Trimless	White	190	27
		Black, Champagne, Dark bronze	148	21
		Satin silver, Matte silver	166	24
2700K	Trimless	White	166	24
		Black, Champagne, Dark bronze	129	18
		Satin silver, Matte silver	145	21

PETITE 1" MULTI-APERTURE

ROUND RECESSED ADJUSTABLE

NEW CONSTRUCTION



Photometrics

STATIC WHITE - ADJUSTABLE CUT CONE

Values calculated based on 3500K, 90+ CRI, and with no lens. The light distribution will vary depending on baffle finish and trim style. All values are per light.

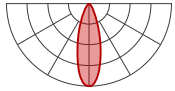

35DEG - 35° Narrow flood

WATTAGE		7 W		10 W	
Trim style	Baffle finish	lm	lm/W	lm	lm/W
Trim	White	359	51	512	51
	Black, Champagne, Dark bronze	330	47	472	47
	Satin silver, Matte silver	357	51	509	51

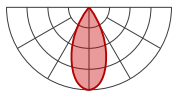

45DEG - 45° Flood

WATTAGE		7 W		10 W	
Trim style	Baffle finish	lm	lm/W	lm	lm/W
Trim	White	409	58	584	58
	Black, Champagne, Dark bronze	353	50	504	50
	Satin silver, Matte silver	389	56	556	56

MULTIPLIERS

Please follow the multiplier tables to ensure correct lumen value. CCT, CRI, and lensing will change the lumen value.

CCT		CRI		LENS	
2400K	0.87	80+ CRI	1	SDL-Soft diffused lens, Solite	0.91
2700K	0.94	90+ CRI	1	No lens	1
3000K	0.98	95+ CRI	0.77		
3500K	1				
4000K	1.05				
5000K	1.05				

PETITE 1" MULTI-APERTURE

ROUND RECESSED ADJUSTABLE

NEW CONSTRUCTION



Technical Specifications

OPTIC

The CircaFlex™ Optic uses advanced beam-splitting technology to allow light to follow an intended optical path with maximal precision, minimal spread, and even distribution.

LIGHT SOURCE

Static white

Compact COB (Chip-On-Board) LED module, available in 2400K, 2700K, 3000K, 3500K, 4000, and 5000K with a choice of 80+ CRI, 90+ CRI, or 95+ CRI, with elevated R9 value for 90+ CRI and above. Color consistency is maintained to within 2 SDCM. All LEDs have been tested in accordance with IESNA LM-80-08 and the results have shown L80 lumen maintenance greater than 60,000 hours. Absolute product photometry is measured and presented in accordance with IESNA LM-79, unless otherwise indicated.

Chromawerx SOLA

Chromawerx SOLA is single-channel control that dims output while warming the color temperature in a pre-determined relationship. Two color temperature range options are offered: 3000K to 1800K, and 2700K to 1800K. A simple analog control adjusts a specially populated LED array to emulate the effect of dimming a filament source.

Chromawerx DUO

Chromawerx DUO offers a two-channel control system which uses analog or digital protocols for synchronous control of both cool to warm LED arrays - maintaining a CRI above 90. Two color temperature range options are offered: 6500K to 2700K, and 5000K to 2700K. The range of color DUO offers is useful for entraining circadian rhythms, stimulating alertness, and compensating for jet lag among other applications. The Chromawerx drivers are programmed to limit maximum light output and power usage across all color temperatures. When paired with DALI drivers (DDA/DDA8), color tuning follows a linear dimming curve.

ELECTRICAL

Unless otherwise specified, dimming down to 1%. At maximum driver load: efficiency > 84%, PF > 0.9, THD < 20%.

Integral: 0-10V, ELV, TRIAC, eldoLED 1% ECOdrive 0-10V, eldoLED 0.1% SOLOdrive 0-10V, Lutron Hi-lume Premier 0.1% EcoSystem

Remote: 0-10V, ELV, TRIAC, Lutron Hi-lume 1% Eco, DALI, eldoLED 1% ECOdrive 0-10V, eldoLED 0.1% SOLOdrive 0-10V, Lutron Hi-lume Premier 0.1% EcoSystem, DMX, Lutron DALI-2 digital

Emergency battery option: Remotely-installed, long-life, high-temperature, maintenance-free, Bodine Lithium-Ion battery pack with self-test functionality, test switch and charge indicator. IOTA and Fulham options available upon request. Minimum of 90 minutes operation, and recharge time of 24 hours. For fixtures less than 10 W, the battery provides 6 W of emergency light output. For fixtures 10 W and over, the battery provides 10 W.

PoE

Depending on the PoE manufacturer selected, Lumenwerx will install the node in factory as either integral to the luminaire, or as a remote module. Factory programming of the PoE node may or may not enable the following functionalities: lumen package, DUO (tunable white), QUADRO (RGBW), emergency battery backup, and sensor integration. These must be addressed and evaluated on a case-by-case basis.

CONSTRUCTION

Housing: For new construction, 20 gauge powder coated steel. 18 gauge galvanized steel junction box with ½" trade size knockouts. Adjustable standard, flush mount, adjustable commercial, and adjustable hat channel bar hangers are available as mounting options.

Baffle: Die-cast aluminum mounted with retaining spring clips

Glow ring: Acrylic

Heat sink: Die-cast aluminum

WEIGHT

	1 X 2	1 X 3
Integral	5.1 lbs - 2.3 kg	6.2 lbs - 2.8 kg
Remote	3.2 lbs - 1.4 kg	4.2 lbs - 1.9 kg

LENS



Soft diffused lens, Solite

ENVIRONMENT

Ambient temperature at fixture location shall be within 0°C/32°F - 25°C/77°F, indoor dry or damp as well as outdoor damp use (canopies or marquees)

CERTIFICATIONS

ETL: Rated for indoor dry/damp locations. Conforms to UL Standard 1598 and certified to CAN/CSA Standard C22.2 No. 250.0.

Chicago Plenum: City of Chicago approved (CCEA) when specified with CP installation type option.

IC rated: Suitable for direct contact with insulation when specified with IC or CP installation type options.

WARRANTY

Lumenwerx provides a five-year limited warranty on electrical and mechanical performance of the luminaires, including the LED boards, drivers, and auxiliary electronics. Lumenwerx will repair or replace defective luminaires or components at our discretion, provided they have been installed and operated in accordance with our specifications. Other limitations apply, please refer to the full warranty on our website.