

PETITE 1" MULTI-APERTURE

ROUND RECESSED WALL WASH

NEW CONSTRUCTION

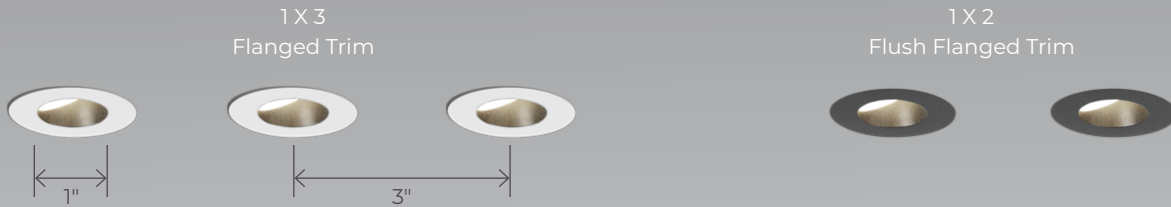

The Petite family strikes that perfect balance of compact size, streamlined aesthetics, and high performance. Through their 1" apertures, these meticulously engineered downlight, cylinder, and multi-aperture luminaires breathe light into spaces with a quiet, straightforward sophistication.

Array



Beam Angles



Wall Wash

Light Source



Ceiling Types



Plenum Clearance

As low as 1 3/4"



Petite Family (Refer to other spec sheets)

Downlight



Adjustable



Recessed



Wall Wash

Multi-aperture



Adjustable



Recessed



Wall Wash

Cylinder



Pendant



Surface

PETITE 1" MULTI-APERTURE

ROUND RECESSED WALL WASH

NEW CONSTRUCTION



Project: _____
 Type: _____

Order Guide

LUMINAIRE ID ¹	ARRAY	TRIM STYLE	BAFFLE FINISH	TRIM FLANGE FINISH	LENS
PETIMRRWW					WW
PETIMRRWW - Petite 1" Multi-aperture Round Recessed Wall Wash ¹ Recessed (fixed) and Recessed Adjustable also available. Consult other spec sheets.	1X2M - 1 X 2 1X3M - 1 X 3	TRM - Flanged trim TRMP - Flush flanged trim drywall mudplate TRMW - Flush flanged trim millwork	FTMW - Matte white FTMB - Matte black FSPC - Satin silver FSSPC - Matte silver FCHP - Champagne FDBZ - Dark bronze FPF - Primer finish CF# - Custom finish, specify RAL#	FTMW - Matte white FTMB - Matte black FSPC - Satin silver FSSPC - Matte silver FCHP - Champagne FDBZ - Dark bronze FPF - Primer finish CF# - Custom finish, specify RAL#	WW - Wall wash diffuser
CEILING THICKNESS	INSTALLATION TYPE ²	MOUNTING OPTION ⁴	LIGHT SOURCE	BEAM	COLOR QUALITY
				WW	
05IN - Up to 0.5" 1IN - 0.5" - 1"	IC ³ - Type-IC NIC ³ - Type Non-IC CP ³ - Chicago Plenum Type-IC (CCEA) ² See page 3 for more details. ³ See Wattage section for limitations.	ASB - Adjustable standard bar hangers FMB - Flush mount bars ACB - Adjustable commercial bar hangers AHC - Adjustable hat channel bars NA - No bar hangers ⁴ See page 4 for more details.	SW - Static white SOLA - Dim-to-warm single channel control DUO - Tunable white 2-channel control	WW - Wall wash	2STP - 2 Step MacAdam Ellipse 3STP - 3 Step MacAdam Ellipse 3STP - 3 Step MacAdam Ellipse
CRI	COLOR TEMPERATURE	DRIVER ⁶	VOLTAGE	WATTAGE PER LIGHT	DIMMING ¹³
80CRI - 80+ CRI 90CRI - 90+ CRI 95CRI - 95+ CRI	24K ⁵ - 2400K 27K - 2700K 30K - 3000K 35K - 3500K 40K - 4000K 50K ⁵ - 5000K ⁵ Not available with 95+ CRI	INTEGRAL ⁷ ⁶ A driver provided per light. ⁷ Access above the ceiling is required. ⁸ A remote driver box is provided.	120V - 120V 277V - 277V UNV - 120V-277V	7W ^{9,10} - 7 W output, up to 243 lm 10W ^{11,12} - 10 W output, up to 316 lm ⁹ Not available with 1 X 3 array when specified with IC/CP. ¹⁰ Not available with 1 X 3 array when specified with NIC and UNV. ¹¹ Not available with 1 X 3 array or UNV. ¹² Not available with IC/CP.	D1 - 1% 0-10V ELV ¹⁴ - ELV 120V TRI ¹⁴ - TRIAC 120V ELDI - eldoLED 1% ECOdrive 0-10V ELDO - eldoLED 0.1% SOLOdrive 0-10V PEQO ¹⁵ - Lutron Hi-lume Premier 0.1% EcoSystem ¹³ PoE (Power-over-Ethernet) compatible. Consult factory for details. ¹⁴ Available with 120V only. ¹⁵ On-site commissioning is required.
90CRI - 90+ CRI	SOLA 30K18K - 3000K to 1800K 27K18K - 2700K to 1800K DUO 65K27K - 6500K to 2700K 50K27K - 5000K to 2700K		SOLA 10W ^{11,12} - 10 W output, up to 244 lm	SOLA 10W ^{11,12} - 10 W output, up to 244 lm	SOLA SDI - Single 0-10V input SELV ¹⁴ - ELV 120V STRI ¹⁴ - TRIAC 120V
			REMOTE ⁸	DO NOT SPECIFY FOR REMOTE. SEE "REMOTE DRIVER BOX" SECTION BELOW.	

Remote Driver Box

Ordered separately. Specify each required remote driver box on a separate line. ←

REMOTE DRIVER ¹⁶	LUMINAIRE QTY. ¹⁷	LUMINAIRE ID	VOLTAGE	WATTAGE PER LIGHT	DIMMING
		PETIMRRWW			
RDB# - Remote driver box ¹⁶ Specify an RDB number (#) for each required remote driver box.	2X ¹⁸ - 2 luminaires 3X ¹⁹ - 3 luminaires ¹⁷ Each luminaire requires its own driver. Specify the number of luminaires per driver box. ¹⁸ Only available with 1 X 2 array. ¹⁹ Only available with 1 X 3 array.	PETIMRRWW - Petite 1" Multi-aperture Round Recessed Wall Wash	120V - 120V 277V - 277V UNV - 120V-277V 347V ²⁰ - 347V ²⁰ Available with RD1 driver only. Please consult factory.	7W ^{21,22} - 7 W output, up to 243 lm 10W ^{23,24} - 10 W output, up to 316 lm ²¹ Not available with 1 X 3 array when specified with IC/CP. ²² Not available with 1 X 3 array when specified with NIC and UNV. ²³ Not available with 1 X 3 array or UNV. ²⁴ Not available with IC/CP.	RD1 - 1% 0-10V RELV ²⁵ - ELV 120V RTRI ²⁵ - TRIAC 120V RLDE1 ²⁶ - Lutron Hi-lume 1% Eco RDA ²⁶ - DALI RELD1 - eldoLED 1% ECOdrive 0-10V ²⁵ Available with 120V only. ²⁶ On-site commissioning is required. ²⁷ To specify, add +EB to the selected dimming option, e.g. RD1+EB.
			SOLA 10W ^{23,24} - 10 W output, up to 244 lm DUO 7W ^{22,24} - 7 W output, up to 205 lm	SOLA RSD1 - Single 0-10V input RSELV ²⁵ - ELV 120V RSTRI ²⁵ - TRIAC 120V	DUO RDMX ²⁶ - DMX RDDA ²⁶ - DALI RSELV ²⁵ - ELV 120V RDDA8 ²⁶ - DALI DT6 DT8
EXAMPLE CODE:	LIGHT	PETIMRRWW-1X2M-TRM-FTMW-FTMW-WW-05IN-IC-ASB-SW-WW-2STP-90+CRI-35K-REMOTE			REMOTE DRIVER RDB1-2X-PETIMRRWW-120V-7W-RD1



PETITE 1" MULTI-APERTURE

ROUND RECESSED WALL WASH

NEW CONSTRUCTION



Installation Types

IC - Type-IC / NIC - Type Non-IC / CP - Chicago Plenum Type-IC (CCEA)		
INSTALLATION TYPE	1X2M - 1 X 2	1X3M - 1 X 3
INTEGRAL		
REMOTE		

- For integral, access above the ceiling is required.
 - For dimension B, see the PLENUM CLEARANCE table below.

PLENUM CLEARANCE

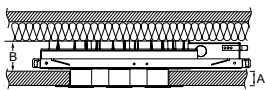

IC/CP - Insulated ceiling

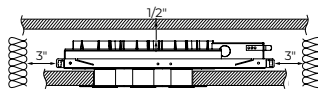

NIC* - Non-insulated ceiling
 * No insulation within 3" of the fixture.

CUT-OUT DIMENSIONS

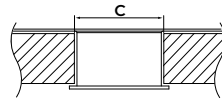

TRM - TRMP - TLMP - GLR

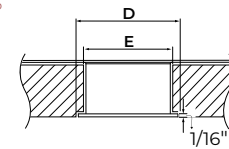

TRMW

PLENUM CLEARANCE HEIGHT AND CEILING THICKNESS					
		IC/CP		NIC	
A	Ceiling thickness	1IN	0.5IN	1IN	0.5IN
B	Integral	2 1/8" (FMB) 4" (ASB, ACB, AHC)		2 5/8" (FMB) 4" (ASB, ACB, AHC)	
	Remote	1 3/4" (FMB) 4" (ASB, ACB, AHC)	2 1/8" (FMB)	2 1/4" (FMB)	2 5/8" (FMB) 4" (ASB, ACB, AHC)

CUT-OUT DIMENSIONS				
		Drywall	Acoustic tile	Millwork
C	TRM	Ø 1 11/16"		N/A
	TRMP	Ø 1 11/16"	N/A	
D	TRMW	N/A		Ø 1 13/16"
E		N/A		Ø 1 11/16" with 1/16" lip

PETITE 1" MULTI-APERTURE

ROUND RECESSED WALL WASH

NEW CONSTRUCTION



Mounting Options

ASB - Adjustable Standard Bar Hangers

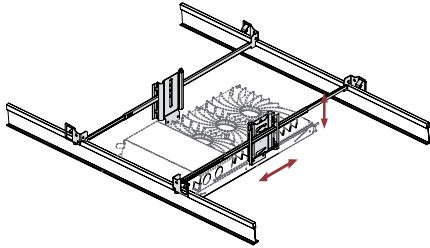

Adjustable Standard Bar hangers can be used in both commercial and residential applications and are adjustable to various heights in both Grid Ceiling and Drywall mounting. ASB hangers are less rigid and versatile than ACB hangers.

FMB - Flush Mount Bars

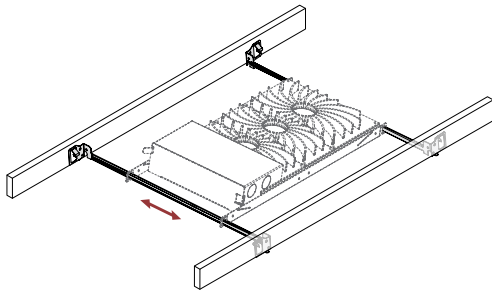

Flush Mount Bars are best used in residential applications, fitting snug to the surface and suitable for Wood, Metal, and Drywall mounting. The flush mounted bars are static and can't be adjusted.

ACB - Adjustable Commercial Bar Hangers

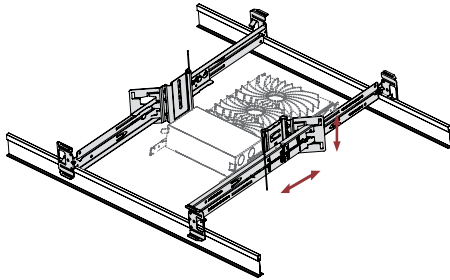

Adjustable Commercial Bar hangers can be used in both commercial and residential applications and are by far the most versatile mounting bar we offer with its adjustability to various heights. ACB hangers are suitable for Grid Ceiling, Drywall, Metal, Wood and Frame mounting.

- Extremely rigid
- Fits into C-Channel notches in a Butterfly Bracket

AHC - Adjustable Hat Channel Bars

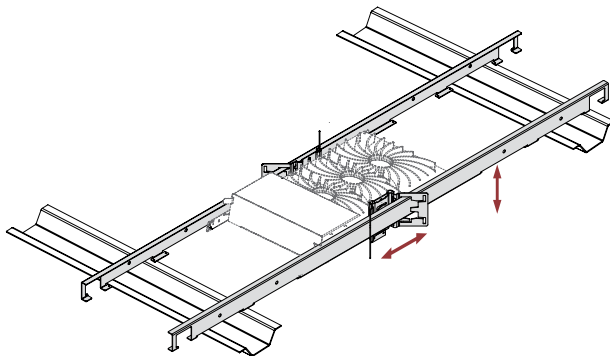

Adjustable Hat Channel bars can be used in both commercial and residential applications and come with a butterfly clip to adjust to various heights. AHC bars can be hung downward by 90 degrees in vertical position, and once wired, can be shifted onto the horizontal mounting plane. AHC bars are suitable for both Drywall and wood ceiling applications.

PETITE 1" MULTI-APERTURE

ROUND RECESSED WALL WASH

NEW CONSTRUCTION



Trim Style

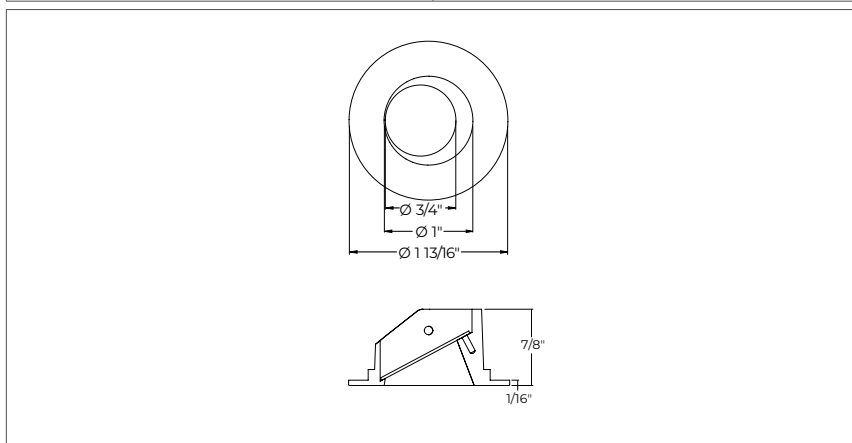
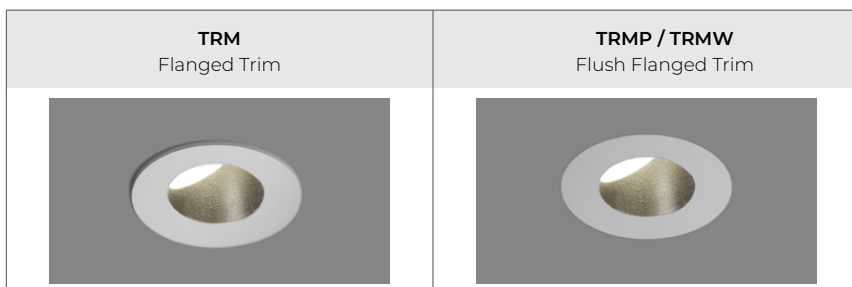
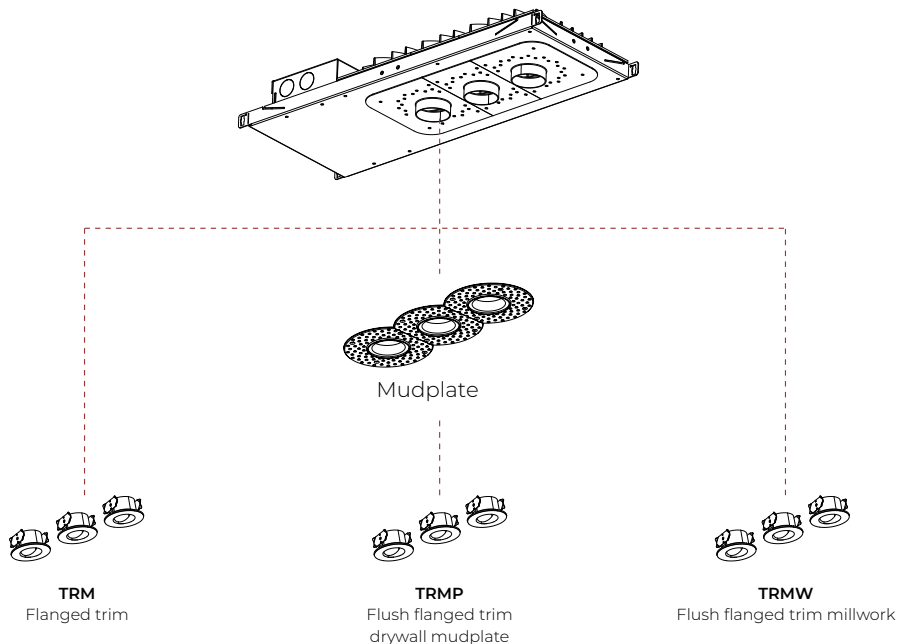

PETITE 1" MULTI-APERTURE

ROUND RECESSED WALL WASH

NEW CONSTRUCTION



Color Quality

COLOR QUALITY - 3500K	
TM-30 Rr	91
TM-30 Ra	100
CRI	90+
R9	> 50

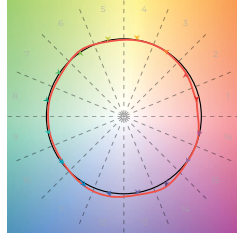

Photometrics

Values calculated based on 3500K and 90+ CRI for static white. The light distribution will vary depending on trim style and baffle finish. All values are per light.

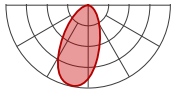

ww - Wall Wash

STATIC WHITE

WATTAGE		7 W		10 W	
Trim style	Baffle finish	lm	lm/W	lm	lm/W
Trim	White	243	35	316	32
	Black, Champagne, Dark bronze	190	27	246	25
	Satin silver, Matte silver	217	31	281	28

MULTIPLIERS

Please follow the multiplier tables to ensure correct lumen value. CCT and CRI will change the lumen value.

CCT		CRI	
2400K	0.87	80+ CRI	1
2700K	0.94	90+ CRI	1
3000K	0.98	95+ CRI	0.77
3500K	1		
4000K	1.05		
5000K	1.05		

SOLA

WATTAGE			10 W	
CCT	Trim style	Baffle finish	lm	lm/W
3000K	Trim	White	244	24
		Black, Champagne, Dark bronze	190	19
		Satin silver, Matte silver	213	21
2700K	Trim	White	244	24
		Black, Champagne, Dark bronze	190	19
		Satin silver, Matte silver	213	21

DUO

WATTAGE			7 W	
CCT	Trim style	Baffle finish	lm	lm/W
6000K	Trim	White	205	29
		Black, Champagne, Dark bronze	160	23
		Satin silver, Matte silver	179	26
5000K	Trim	White	205	29
		Black, Champagne, Dark bronze	160	23
		Satin silver, Matte silver	179	26
2700K	Trim	White	180	26
		Black, Champagne, Dark bronze	140	20
		Satin silver, Matte silver	157	22



PETITE 1" MULTI-APERTURE

ROUND RECESSED WALL WASH

NEW CONSTRUCTION



Technical Specifications

OPTIC

The CircaFlex™ Optic uses advanced beam-splitting technology to allow light to follow an intended optical path with maximal precision, minimal spread, and even distribution.

LIGHT SOURCE

Static white

Compact COB (Chip-On-Board) LED module, available in 2400K, 2700K, 3000K, 3500K, 4000, and 5000K with a choice of 80+ CRI, 90+ CRI, or 95+ CRI, with elevated R9 value for 90+ CRI and above. Color consistency is maintained to within 2 SDCM. All LEDs have been tested in accordance with IESNA LM-80-08 and the results have shown L80 lumen maintenance greater than 60,000 hours. Absolute product photometry is measured and presented in accordance with IESNA LM-79, unless otherwise indicated.

Chromawerx SOLA

Chromawerx SOLA is single-channel control that dims output while warming the color temperature in a pre-determined relationship. Two color temperature range options are offered: 3000K to 1800K, and 2700K to 1800K. A simple analog control adjusts a specially populated LED array to emulate the effect of dimming a filament source.

Chromawerx DUO

Chromawerx DUO offers a two-channel control system which uses analog or digital protocols for synchronous control of both cool to warm LED arrays - maintaining a CRI above 90. Two color temperature range options are offered: 6500K to 2700K, and 5000K to 2700K. The range of color DUO offers is useful for entraining circadian rhythms, stimulating alertness, and compensating for jet lag among other applications. The Chromawerx drivers are programmed to limit maximum light output and power usage across all color temperatures. When paired with DALI drivers (DDA/DDA8), color tuning follows a linear dimming curve.

ELECTRICAL

Unless otherwise specified, dimming down to 1%. At maximum driver load: efficiency > 84%, PF > 0.9, THD < 20%.

Integral: 0-10V, ELV, TRIAC, eldoLED 1% ECOdrive 0-10V, eldoLED 0.1% SOLOdrive 0-10V, Lutron Hi-lume Premier 0.1% EcoSystem

Remote: 0-10V, ELV, TRIAC, Lutron Hi-lume 1% Eco, DALI, eldoLED 1% ECOdrive 0-10V, eldoLED 0.1% SOLOdrive 0-10V, Lutron Hi-lume Premier 0.1% EcoSystem, DMX, Lutron DALI-2 digital

Emergency battery option: Remotely-installed, long-life, high-temperature, maintenance-free, Bodine Lithium-Ion battery pack with self-test functionality, test switch and charge indicator. IOTA and Fulham options available upon request. Minimum of 90 minutes operation, and recharge time of 24 hours. For fixtures less than 10 W, the battery provides 6 W of emergency light output. For fixtures 10 W and over, the battery provides 10 W.

PoE

Depending on the PoE manufacturer selected, Lumenwerx will install the node in factory as either integral to the luminaire, or as a remote module. Factory programming of the PoE node may or may not enable the following functionalities: lumen package, DUO (tunable white), QUADRO (RGBW), emergency battery backup, and sensor integration. These must be addressed and evaluated on a case-by-case basis.

CONSTRUCTION

Housing: For new construction, 20 gauge powder coated steel. 18 gauge galvanized steel junction box with ½" trade size knockouts. Adjustable standard, flush mount, adjustable commercial, and adjustable hat channel bar hangers are available as mounting options.

Baffle: Die-cast aluminum mounted with retaining spring clips

Heat sink: Die-cast aluminum

WEIGHT

	1 X 2	1 X 3
Integral	5.1 lbs - 2.3 kg	6.2 lbs - 2.8 kg
Remote	3.2 lbs - 1.4 kg	4.2 lbs - 1.9 kg

LENS



Wall Wash

ENVIRONMENT

Ambient temperature at fixture location shall be within 0°C/32°F - 25°C/77°F, indoor dry or damp as well as outdoor damp use (canopies or marquees).

CERTIFICATION

ETL: Rated for indoor dry/damp locations. Conforms to UL Standard 1598 and certified to CAN/CSA Standard C22.2 No. 250.0.

Chicago Plenum: City of Chicago approved (CCEA) when specified with CP installation type option.

IC rated: Suitable for direct contact with insulation when specified with IC or CP installation type options.

WARRANTY

Lumenwerx provides a five-year limited warranty on electrical and mechanical performance of the luminaires, including the LED boards, drivers, and auxiliary electronics. Lumenwerx will repair or replace defective luminaires or components at our discretion, provided they have been installed and operated in accordance with our specifications. Other limitations apply, please refer to the full warranty on our website.