

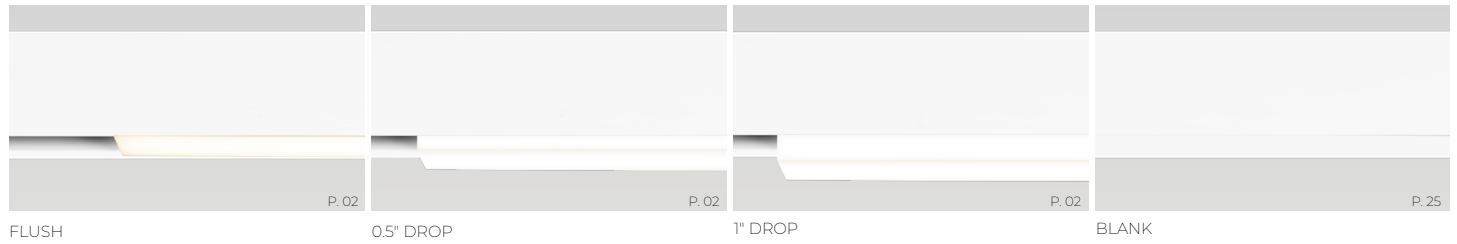

HLO/BLANK

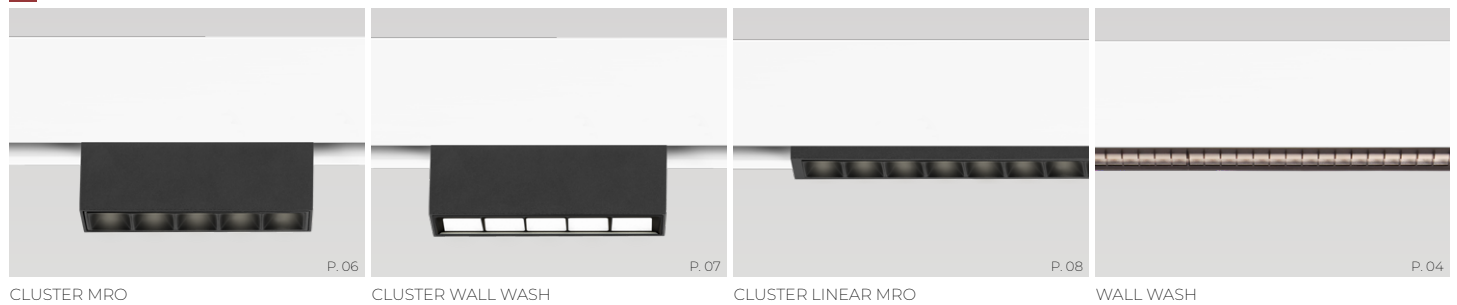

CLUSTER/WALL WASH



DOT/BOX

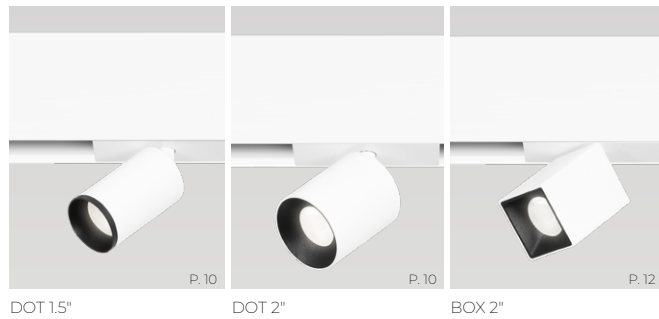

CYLINDER



GLOBE

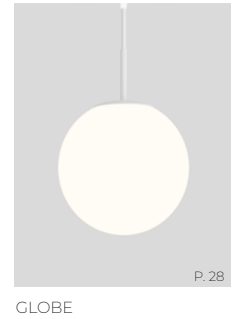

CARET/CUPOLA/TOTE

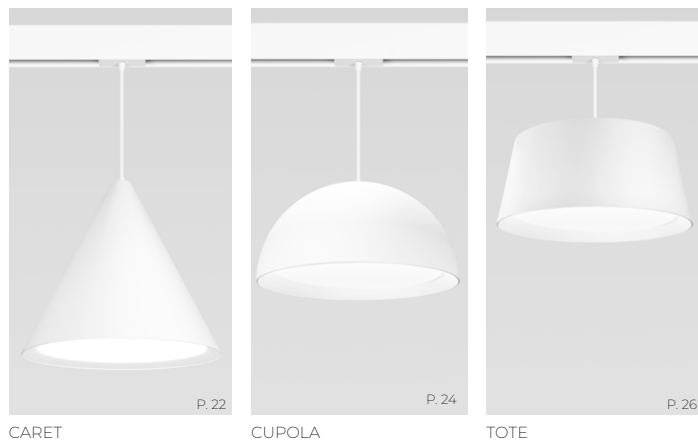

SHELL



CELLA



OBE



PIVOT MODULE

STATIC WHITE, FULL SPECTRUM



Project: _____

 Type: _____

PIVOT HLO

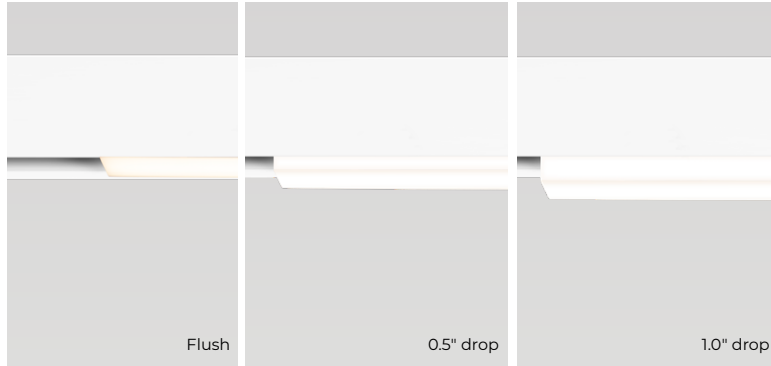

DESCRIPTION

Pivot HLO modules offer smooth, elegant lighting with an impressive power output of up to 1000 lm/ft, perfect for areas that require an added punch of illumination. The HLO (High-Efficiency Lambertian Optic) Flush and Drop modules come in 1' to 8' increments.

Pivot HLO

LUMINAIRE ID	LENS POSITION	LENGTH	LIGHT SOURCE	CRI	LUMEN PACKAGE	COLOR TEMPERATURE
PIVHLO - Pivot HLO PIVHLOD - Pivot HLO Drop	FH¹ - Flush 0.5D² - 0.5" drop 1.0D² - 1.0" drop ¹ Only available for Pivot HLO. ² Only available for Pivot HLO Drop.	1FT - 1' 2FT - 2' 3FT - 3' 4FT - 4' 5FT - 5' 6FT - 6' 7FT - 7' 8FT - 8'	SW - Static white FS - Full spectrum static white	80CRI³ - 80+ CRI 90CRI³ - 90+ CRI 95CRI - 95+ CRI ³ Not available with full spectrum.	500LMF - 500 lm/ft 750LMF - 750 lm/ft 1000LMF⁴ - 1000 lm/ft ⁴ Not available with 95+ CRI.	27K - 2700K 30K - 3000K 35K - 3500K 40K - 4000K

MODULE FINISH ⁵	CHANNEL POSITION ⁶
FTMB - Matte black FTMW - Matte white CF# - Custom finish, specify RAL# ⁵ See page 30 for more finish options.	USC - Unified single channel DUC1 - Dual channel 1 DUC2 - Dual channel 2 ⁶ The channel position of each module must correspond to the channel option selected for the track. With USC, all modules will be controlled together. With DUC, specify either DUC1 or DUC2 for each module.



PIVOT MODULE

STATIC WHITE, FULL SPECTRUM



Project: _____

Type: _____

Dimensions

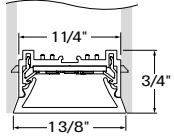

PIVHLO - Pivot HLO - Flush

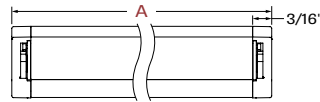

PIVHLO - Pivot HLO - Side view

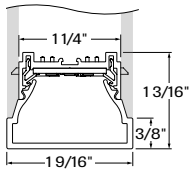

PIVHLOD - Pivot HLO Drop - 0.5D

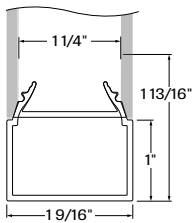

PIVHLOD - Pivot HLO Drop - 1D

NOMINAL LENGTH	A		WEIGHT	
	TOTAL LENGTH			
1'	12 7/16"		0.4 lb	0.18 kg
2'	23 11/16"		0.73 lb	0.33 kg
3'	35 11/16"		1.08 lb	0.49 kg
4'	46 15/16"		1.41 lb	0.64 kg
5'	58 7/8"		1.75 lb	0.8 kg
6'	70 7/8"		2.09 lb	0.95 kg
7'	82 7/8"		2.43 lb	1.11 kg
8'	94 7/8"		2.78 lb	1.26 kg

Photometrics

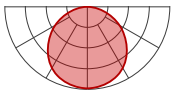

PIVOT HLO - Flush

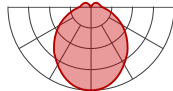

PIVOT HLO Drop - 0.5D

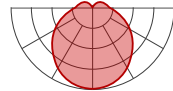

PIVOT HLO Drop - 1D

Module wattage (W)

NOMINAL LENGTH	LUMEN PACKAGE at 3500K/80+ CRI		
	500	750	1000
1'	5.1 W	7.7 W	10.3 W
2'	10.2 W	15.4 W	20.6 W
3'	15.3 W	28.1 W	30.9 W
4'	20.4 W	30.8 W	41.2 W
5'	25.5 W	38.5 W	51.5 W
6'	30.6 W	46.2 W	61.8 W
7'	35.7 W	53.9 W	72.1 W
8'	40.8 W	61.6 W	82.4 W

Multiplier - CCT/CRI

CCT	Lumens		
	80+ CRI	90+ CRI	95+ CRI
2700K	0.96	0.81	0.80
3000K	0.99	0.83	0.83
3500K	1.00	0.85	0.84
4000K	1.03	0.87	0.86

Multiplier - Drop lens

Lens position	Watts	Lumens
Flush Lens	1.00	1.00
Drop Lens 0.5"	1.00	1.30
Drop Lens 1.0"	1.00	1.30

PIVOT MODULE

STATIC WHITE, FULL SPECTRUM



Project: _____
 Type: _____

PIVOT WALL WASH

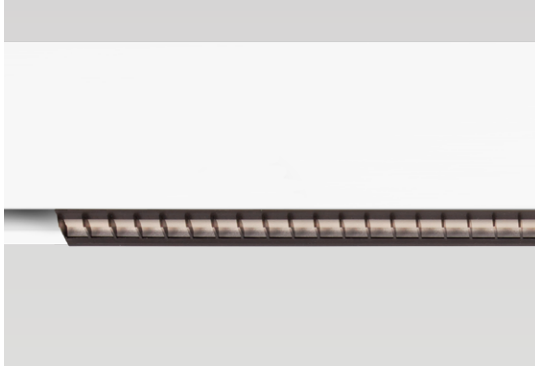

DESCRIPTION

Pivot Wall Wash offers a fresh, two-tiered strategy to wall washing with its Total Internal Reflector (TIR) optic and a louver available in black or white. This approach results in an impressive minimal 5% light spill, which differentiates Pivot's wall wash from others. Pivot Wall Wash is almost as fluid as a gentle wall grazer due to its impressive uniformity. It comes in 1' to 8' increments.

Pivot Wall Wash

LUMINAIRE ID	LENGTH	LIGHT SOURCE	CRI	LUMEN PACKAGE	COLOR TEMPERATURE	LOUVER FINISH
PIVWW						
PIVWW - Pivot Wall Wash	1FT - 1' 2FT - 2' 3FT - 3' 4FT - 4' 5FT - 5' 6FT - 6' 7FT - 7' 8FT - 8'	SW - Static white FS - Full spectrum static white	80CRI ¹ - 80+ CRI 90CRI ¹ - 90+ CRI 95CRI - 95+ CRI ¹ Not available with full spectrum.	350LMF - 350 lm/ft 500LMF ^{2,3} - 500 lm/ft 750LMF ^{4,5,6,7} - 750 lm/ft ² Not available with black louver at 95+ CRI. ³ Not available with black louver at 7' or 8'. ⁴ Available with pendant track only. ⁵ Not available with black louver. ⁶ Not available with 95+ CRI. ⁷ Not available with 8'.	27K - 2700K 30K - 3000K 35K - 3500K 40K - 4000K	MF01 - Matte white MF04 - Matte black

MODULE FINISH ⁸	CHANNEL POSITION ⁹
FTMB - Matte black FTMW - Matte white CF# - Custom finish, specify RAL# ⁸ See page 30 for more finish options.	USC - Unified single channel DUC1 - Dual channel 1 DUC2 - Dual channel 2 ⁹ The channel position of each module must correspond to the channel option selected for the track. With USC, all modules will be controlled together. With DUC, specify either DUC1 or DUC2 for each module.

PIVOT MODULE

STATIC WHITE, FULL SPECTRUM



Project: _____
 Type: _____

Dimensions

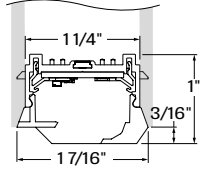

PIVWW - Pivot Wall Wash

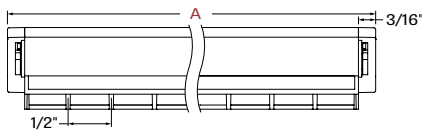

PIVWW - Pivot Wall Wash - Side view

NOMINAL LENGTH	A		WEIGHT	
	TOTAL LENGTH			
1'	12 7/16"		0.53 lb	0.24 kg
2'	28 7/16"		0.99 lb	0.45 kg
3'	36 7/16"		1.48 lb	0.67 kg
4'	48 7/16"		1.94 lb	0.88 kg
5'	60 7/16"		2.42 lb	1.1 kg
6'	72 7/16"		2.91 lb	1.32 kg
7'	84 7/16"		3.39 lb	1.54 kg
8'	96 7/16"		3.88 lb	1.76 kg

Photometrics

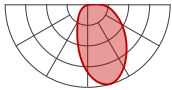

Module wattage (W)

NOMINAL LENGTH	WHITE LOUVER			BLACK LOUVER	
	LUMEN PACKAGE at 3500K/80+ CRI			LUMEN PACKAGE at 3500K/80+ CRI	
	350	500	750	350	500
1'	5.9 W	8.5 W	12.7 W	10.4 W	14.9 W
2'	11.8 W	17 W	25.4 W	20.8 W	29.8 W
3'	17.7 W	25.5 W	38.1 W	31.2 W	44.7 W
4'	28.6 W	34 W	50.8 W	41.6 W	59.6 W
5'	29.5 W	42.5 W	63.5 W	52 W	74.5 W
6'	35.4 W	51 W	76.2 W	62.4 W	89.4 W
7'	41.3 W	59.5 W	88.9 W	72.8 W	N/A
8'	47.2 W	68 W	N/A	83.2 W	N/A

Multiplier - CCT/CRI

CCT	Lumens		
	80+ CRI	90+ CRI	95+ CRI
2700K	0.95	0.79	0.74
3000K	0.98	0.81	0.76
3500K	1.00	0.84	0.77
4000K	1.00	0.84	0.79

PIVOT MODULE

STATIC WHITE, FULL SPECTRUM



Project: _____
 Type: _____

PIVOT CLUSTER MRO



DESCRIPTION

Pivot Cluster MRO adds the beneficial precision and scalability of the Cluster family of luminaires to the Pivot Track Lighting System. Based on a 1.2" square form, Pivot Cluster modules offer two optic options—soft edge MRO (Mini Reflector Optics), and sharp edge MRO (Mini Reflector Optics), as well as three baffle options—square, hyperbolic, and conical.

Pivot Cluster MRO

LUMINAIRE ID	LENGTH	OPTIC	LIGHT SOURCE	BEAM	CRI	LUMEN PACKAGE ⁵
PIVCLUM	6IN					750LM
PIVCLUM - Pivot Cluster MRO 1x5	6IN - 6"	SOF - Soft edge downlight REF - Sharp edge downlight	SW - Static white FS - Full spectrum static white	SPT ¹ - Spot NFL ² - Narrow flood FLD - Flood WFL - Wide flood	80CRI ³ - 80+ CRI 90CRI ³ - 90+ CRI 95CRI ⁴ - 95+ CRI	750LM - 750 lm, 9.4 W ⁵ Lumen outputs are reduced with full spectrum, consult factory.

COLOR TEMPERATURE	LOUVER TYPE	LOUVER FINISH	MODULE FINISH ⁶	CHANNEL POSITION ⁷
27K - 2700K 30K - 3000K 35K - 3500K 40K - 4000K	SQR - Square HYP - Hyperbolic	MF01 - Matte white MF04 - Matte black BL05 - Black chrome	FTMB - Matte black FTMW - Matte white CF# - Custom finish, specify RAL# ⁶ See page 30 for more finish options.	USC - Unified single channel DUC1 - Dual channel 1 DUC2 - Dual channel 2 ⁷ The channel position of each module must correspond to the channel option selected for the track. With USC, all modules will be controlled together. With DUC, specify either DUC1 or DUC2 for each module.

Dimensions

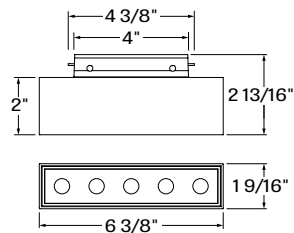

PIVCLUM - Pivot Cluster MRO

NOMINAL LENGTH	WEIGHT	
6"	1.1 lb	0.5 kg

Photometrics

SOFT-EDGE DOWNLIGHT

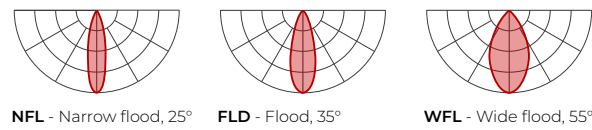

SHARP-EDGE DOWNLIGHT

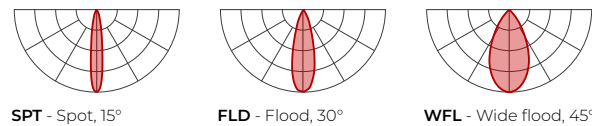

Module wattage (W)

NOMINAL LENGTH	LUMEN PACKAGE at 3500K/80+ CRI
6"	750
6"	9.4 W

Multiplier - CCT/CRI

CCT	Lumens	
	80+ CRI	90+ CRI
2700K	0.96	0.84
3000K	1.00	0.87
3500K	1.00	0.89
4000K	1.01	0.91

PIVOT MODULE

STATIC WHITE, FULL SPECTRUM



Project: _____
 Type: _____

PIVOT CLUSTER WALL WASH

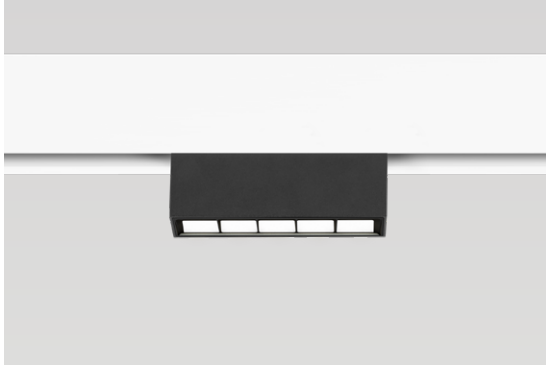

DESCRIPTION

Pivot Cluster Wall Wash 1x5 adds the beneficial precision and scalability of the Cluster family of luminaires to the Pivot Track Lighting System. Pivot Cluster Wall Wash maintain the small cell look of Cluster MRO option for Pivot. Based on a 1.2" square form, Pivot Cluster Wall Wash features an asymmetric distribution and is offered in both black and white louvered options.

Pivot Cluster Wall Wash

LUMINAIRE ID	LENGTH	LIGHT SOURCE	CRI	LUMEN PACKAGE ³	COLOR TEMPERATURE	LOUVER FINISH
PIVCLUWW	6IN			500LM		
PIVCLUWW - Pivot Cluster Wall Wash 1x5	6IN - 6"	SW - Static white FS - Full spectrum static white	80CRI ¹ - 80+ CRI 90CRI ¹ - 90+ CRI 95CRI ² - 95+ CRI	500LM - 500 lm, 9 W ³ Lumen outputs are reduced with full spectrum, consult factory.	27K - 2700K 30K - 3000K 35K - 3500K 40K - 4000K	MF01 - Matte white MF04 - Matte black

¹Not available with full spectrum.
²Available with full spectrum only.

MODULE FINISH ⁴	CHANNEL POSITION ⁵
FTMB - Matte black FTMW - Matte white CF# - Custom finish, specify RAL# ⁴ See page 30 for more finish options.	USC - Unified single channel DU1 - Dual channel 1 DU2 - Dual channel 2 ⁵ The channel position of each module must correspond to the channel option selected for the track. With USC, all modules will be controlled together. With DUC, specify either DU1 or DU2 for each module.

Dimensions

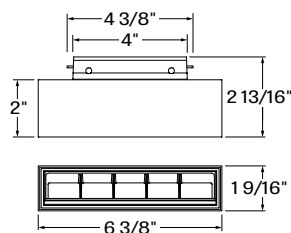

PIVCLUWW
- Pivot Cluster Wall Wash

NOMINAL LENGTH	WEIGHT
6"	1.1 lb 0.5 kg

Photometrics

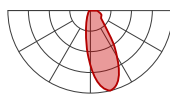

Module wattage (W)

NOMINAL LENGTH	LUMEN PACKAGE at 3500K/80+ CRI
6"	500
	9 W

Multiplier - CCT/CRI

CCT	Lumens	
	80+ CRI	90+ CRI
2700K	0.96	0.84
3000K	1.00	0.87
3500K	1.00	0.89
4000K	1.01	0.91

PIVOT MODULE

STATIC WHITE, FULL SPECTRUM



Project: _____
 Type: _____

PIVOT CLUSTER LINEAR MRO

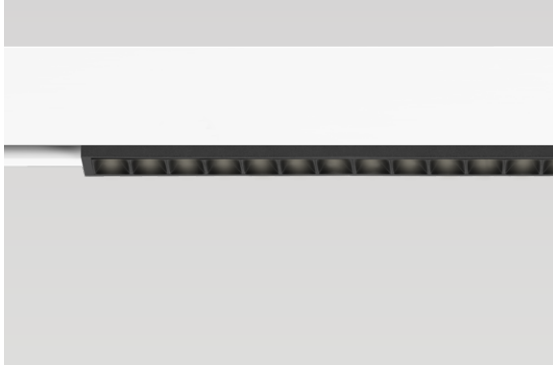

DESCRIPTION

Pivot Cluster Linear MRO adds the beneficial precision and scalability of the Cluster family of luminaires to the Pivot Track Lighting System. Based on a 1.2" square form, Pivot Cluster modules offer a soft edge optic option and three baffle options—square, hyperbolic, and conical. Pivot Cluster Linear MRO (Mini Reflector Optics) is offered in 4 lengths: 6" (1x5), 9" (1x7), 17" (1x14), and 25" (1x21).

Pivot Cluster Linear MRO

LUMINAIRE ID	LENGTH	OPTIC	LIGHT SOURCE	BEAM	CRI	LUMEN PACKAGE ³
PIVCLULINM		SOF				
PIVCLULINM - Pivot Cluster Linear MRO	6IN - 6" (1X5)	SOF - Soft edge downlight	SW - Static white FS - Full spectrum static white	NFL - Narrow flood FLD - Flood WFL - Wide flood	80CRI ¹ - 80+ CRI 90CRI ¹ - 90+ CRI 95CRI ² - 95+ CRI	1x5 750LM - 750 lm, 9.4 W
	9IN - 9" (1X7)					1x7 1000LM - 1000 lm, 9.2 W
	17IN - 17" (1X14)					1x14 2000LM - 2000 lm, 18.4 W
	25IN - 25" (1X21)					1x21 3000LM - 3000 lm, 27.6 W
					¹ Not available with full spectrum. ² Available with full spectrum only.	³ Lumen outputs are reduced with full spectrum, consult factory.

COLOR TEMPERATURE	LOUVER TYPE	LOUVER FINISH	MODULE FINISH ⁴	CHANNEL POSITION ⁵
27K - 2700K 30K - 3000K 35K - 3500K 40K - 4000K	SQR - Square HYP - Hyperbolic	MF01 - Matte white MF04 - Matte black BL05 - Black chrome	FTMB - Matte black FTMW - Matte white CF# - Custom finish, specify RAL# ⁴ See page 30 for more finish options.	USC - Unified single channel DUC1 - Dual channel 1 DUC2 - Dual channel 2 ⁵ The channel position of each module must correspond to the channel option selected for the track. With USC, all modules will be controlled together. With DUC, specify either DUC1 or DUC2 for each module.

PIVOT MODULE

STATIC WHITE, FULL SPECTRUM



Project: _____

Type: _____

Dimensions

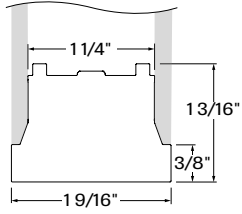

NOMINAL LENGTH	A		WEIGHT	
	TOTAL			
6"	7 3/16"		0.57 lb	0.26 kg
9"	9 9/16"		0.62 lb	0.28 kg
17"	17 15/16"		1.1 lb	0.5 kg
25"	26 3/8"		1.59 lb	0.72 kg

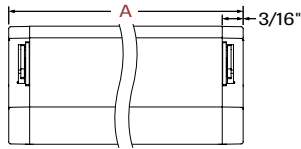

PIVCLULINM - Pivot Cluster Linear MRO

Photometrics

SOFT-EDGE DOWNLIGHT

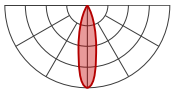

NFL - Narrow flood, 25°

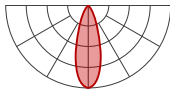

FLD - Flood, 35°

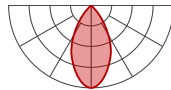

WFL - Wide flood, 55°

Module wattage (W)

NOMINAL LENGTH	LUMEN PACKAGE at 3500K/80+ CRI	WATTAGE
6"	750	9.4 W
9"	1000	9.2 W
17"	2000	18.4 W
25"	3000	27.6 W

Multiplier - CCT/CRI

CCT	Lumens	
	80+ CRI	90+ CRI
2700K	0.96	0.84
3000K	1.00	0.87
3500K	1.00	0.89
4000K	1.01	0.91

PIVOT MODULE

STATIC WHITE, FULL SPECTRUM



Project: _____
 Type: _____

PIVOT DOT

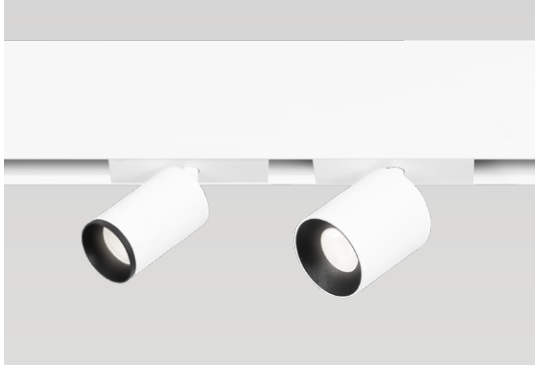

DESCRIPTION

Pivot Dot is a round spotlight offered in two sizes, and features three beam angles of 20°, 35° and 50°. Pivot Dot emits a subtle punch of light with 360° infinite rotation ability along with 90° vertical flexibility. It can be adapter mounted or 3" stem mounted and is offered in 2.65" and 4" heights with two bevel options: standard and decorative. Pivot Dot is available in a wide range of colors.

Pivot Dot

LUMINAIRE ID	HEIGHT	LIGHT SOURCE	BEAM	CRI	LUMEN PACKAGE ²		COLOR TEMP.
PIV1DT - Pivot 1.5" Dot PIV2DT - Pivot 2" Dot	2.65IN - 2.65" 4IN - 4"	SW - Static white FS - Full spectrum static white	20DEG - 20° Spot 35DEG - 35° Narrow flood 50DEG - 50° Wide flood	80CRI ¹ - 80+ CRI 90CRI ¹ - 90+ CRI 95CRI - 95+ CRI	1.5"	2"	27K - 2700K 30K - 3000K 35K - 3500K 40K - 4000K
				¹ Not available with full spectrum.	2.65" height	700LM - 700 lm, 9.4 W 750LM - 750 lm, 11 W	
					4" height	700LM - 700 lm, 9.4 W 850LM - 850 lm, 12.8 W 750LM - 750 lm, 11 W 900LM - 900 lm, 15.8 W	

² Lumen outputs are reduced with full spectrum, consult factory.

BAFFLE	BAFFLE FINISH ⁴	AIMABLE ARM ⁵	MODULE FINISH ^{7,8}	TRACK ADAPTER FINISH ⁹	CHANNEL POSITION ¹⁰
SDB - Standard baffle DCB ³ - Decorative baffle	FTMB - Matte black FTMW - Matte white CF# - Custom finish, specify RAL #	FH - Flush ST3IN ⁶ - 3" long stem	FTMB - Matte black FTMW - Matte white CF# - Custom finish, specify RAL#	FTMB - Matte black FTMW - Matte white CF# - Custom finish, specify RAL#	USC - Unified single channel DUC1 - Dual channel 1 DUC2 - Dual channel 2
³ Recommended when a different finish is desired for the baffle.	⁴ See page 30 for more finish options.	⁵ 90° tilt, infinite rotation. ⁶ Consult factory for longer stem lengths.	⁷ Arm finish will match module. ⁸ See page 30 for more finish options.	⁹ See page 30 for more finish options.	¹⁰ The channel position of each module must correspond to the channel option selected for the track. With USC, all modules will be controlled together. With DUC, specify either DUC1 or DUC2 for each module.

Photometrics

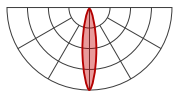

20DEG - 20° Spot

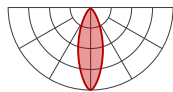

35DEG - 35° Narrow flood

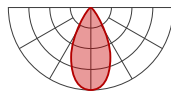

50DEG - 50° Wide flood

Module wattage (W)

SIZE	HEIGHT	LUMEN PACKAGE at 3500K/80+ CRI	WATTAGE
1.5"	2.65", 4"	700	9.4 W
	4"	850	12.8 W
2"	2.65", 4"	750	11 W
	4"	900	15.8 W

Multiplier - CCT/CRI

CCT	Lumens		
	80+ CRI	90+ CRI	95+ CRI
2700K	0.94	0.77	0.72
3000K	0.96	0.82	0.75
3500K	1.00	0.85	0.81
4000K	1.02	0.87	0.79

PIVOT MODULE

STATIC WHITE, FULL SPECTRUM



Project: _____
 Type: _____

Dimensions

Flush Arm (shown with Pivot Dot 2")

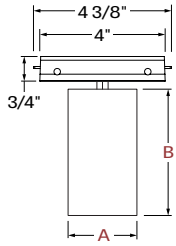

Flush arm
- Standard baffle

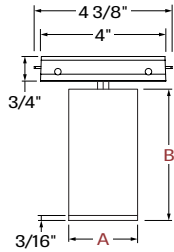

Flush arm
- Decorative baffle

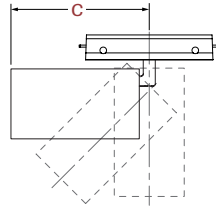

Maximum length
- 90° tilt

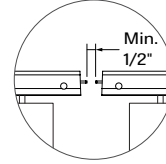

SIZE	A ACTUAL SIZE	B TOTAL LENGTH		C MAX. LENGTH (90° tilt)		WEIGHT	
		Standard baffle	Decorative baffle	Standard baffle	Decorative baffle		
1.5"	Ø 1 11/16"	2 5/8"	2 13/16"	2 15/16"	3 1/8"	0.55 lb	0.25 kg
		4"	4 3/16"	4 5/16"	4 7/16"	0.77 lb	0.35 kg
2"	Ø 2 3/16"	2 5/8"	2 13/16"	2 15/16"	3 1/8"	0.66 lb	0.3 kg
		4"	4 3/16"	4 5/16"	4 7/16"	1.1 lb	0.5 kg

Stem (shown with Pivot Dot 2")

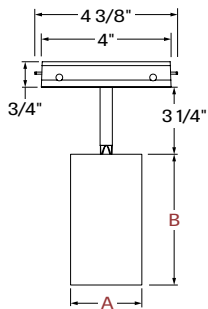

Stem
- Standard baffle

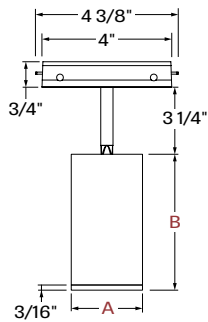

Stem
- Decorative baffle

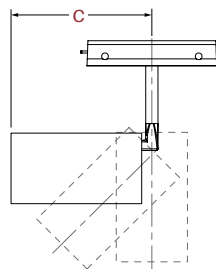

Maximum length
- 90° tilt

SIZE	A ACTUAL SIZE	B TOTAL LENGTH		C MAX. LENGTH (90° tilt)		WEIGHT	
		Standard baffle	Decorative baffle	Standard baffle	Decorative baffle		
1.5"	Ø 1 11/16"	2 5/8"	2 13/16"	2 15/16"	3 1/8"	0.55 lb	0.25 kg
		4"	4 3/16"	4 5/16"	4 7/16"	0.77 lb	0.35 kg
2"	Ø 2 3/16"	2 5/8"	2 13/16"	2 15/16"	3 1/8"	0.66 lb	0.3 kg
		4"	4 3/16"	4 5/16"	4 7/16"	1.1 lb	0.5 kg

PIVOT MODULE

STATIC WHITE, FULL SPECTRUM



Project: _____
 Type: _____

PIVOT BOX



DESCRIPTION

Pivot Box is a square spotlight offered in two sizes, and features three beam angles of 20°, 35° and 50°. Pivot Box emits a subtle punch of light with 360° infinite rotation ability along with 90° vertical flexibility. It can be adapter mounted or 3" stem mounted and is offered in 2.65" and 4" heights with two bevel options: standard and decorative. Pivot Box is available in a wide range of colors.

Pivot Box

LUMINAIRE ID	HEIGHT	LIGHT SOURCE	BEAM	CRI	LUMEN PACKAGE ²		COLOR TEMP.
PIV2BX							
PIV2BX - Pivot 2" Box	2.65IN - 2.65" 4IN - 4"	SW - Static white FS - Full spectrum static white	20DEG - 20° Spot 35DEG - 35° Narrow flood 50DEG - 50° Wide flood	80CRI ¹ - 80+ CRI 90CRI ¹ - 90+ CRI 95CRI - 95+ CRI	2.65" height 4" height	750LM - 750 lm, 11 W 750LM - 750 lm, 11 W 900LM - 900 lm, 15.8 W	27K - 2700K 30K - 3000K 35K - 3500K 40K - 4000K
¹ Not available with full spectrum. ² Lumen outputs are reduced with full spectrum, consult factory.							
BAFFLE	BAFFLE FINISH ⁴	AIMABLE ARM ⁵	MODULE FINISH ^{7,8}	TRACK ADAPTER FINISH ⁹	CHANNEL POSITION ¹⁰		
SDB - Standard baffle DCB ³ - Decorative baffle	FTMB - Matte black FTMW - Matte white CF# - Custom finish, specify RAL#	FH - Flush ST3IN ⁶ - 3" long stem	FTMB - Matte black FTMW - Matte white CF# - Custom finish, specify RAL#	FTMB - Matte black FTMW - Matte white CF# - Custom finish, specify RAL#	USC - Unified single channel DUC1 - Dual channel 1 DUC2 - Dual channel 2		
³ Recommended when a different finish is desired for the baffle.	⁴ See page 30 for more finish options.	⁵ 90° tilt, infinite rotation. ⁶ Consult factory for longer stem lengths.	⁷ Arm finish will match module. ⁸ See page 30 for more finish options.	⁹ See page 30 for more finish options.	¹⁰ The channel position of each module must correspond to the channel option selected for the track. With USC, all modules will be controlled together. With DUC, specify either DUC1 or DUC2 for each module.		

Photometrics

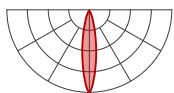

20DEG - 20° Spot

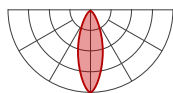

35DEG - 35° Narrow flood

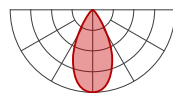

50DEG - 50° Wide flood

Module wattage (W)

SIZE	HEIGHT	LUMEN PACKAGE at 3500K/80+ CRI	WATTAGE
2"	2.65", 4"	750	11 W
	4"	900	15.8 W

Multiplier - CCT/CRI

CCT	Lumens		
	80+ CRI	90+ CRI	95+ CRI
2700K	0.94	0.77	0.72
3000K	0.96	0.82	0.75
3500K	1.00	0.85	0.81
4000K	1.02	0.87	0.79

PIVOT MODULE

STATIC WHITE, FULL SPECTRUM



Project: _____
 Type: _____

Dimensions

Flush Arm

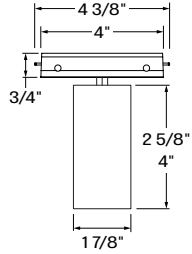

PIV2BX - Pivot 2" Box - Flush
 - Standard baffle

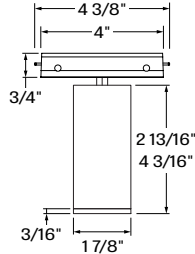

PIV2BX - Pivot 2" Box - Flush
 - Decorative baffle

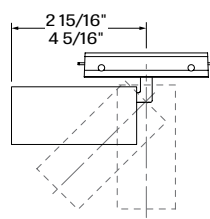

Maximum length
 - Standard baffle
 - 90° tilt

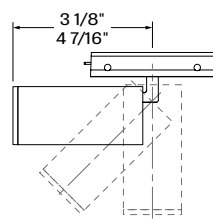

Maximum length
 - Decorative baffle
 - 90° tilt

SIZE	HEIGHT	WEIGHT	
2"	2 5/8"	0.68 lb	0.31 kg
	4"	1.12 lb	0.51 kg

Stem

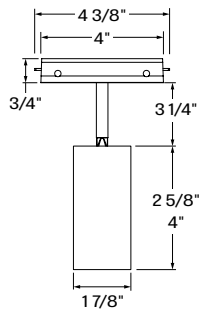

PIV2BX - Pivot 2" Box - Stem
 - Standard baffle

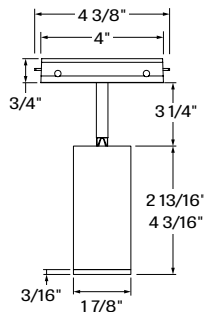

PIV2BX - Pivot 2" Box - Stem
 - Decorative baffle

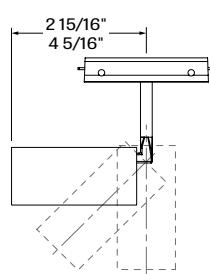

Maximum length
 - Standard baffle
 - 90° tilt

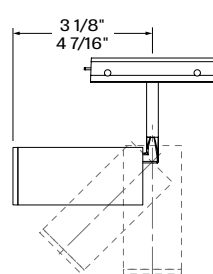

Maximum length
 - Decorative baffle
 - 90° tilt

PIVOT MODULE

STATIC WHITE, FULL SPECTRUM



Project: _____
 Type: _____

PIVOT CYLINDER



DESCRIPTION

Pivot Cylinder is our most powerful point source module with slim 1.5" and 2" profiles and four height options: 6", 9", 12", and 18". Pivot Cylinder is offered in three beam angles of 20°, 35° and 50°. Pivot Cylinders come with the option of a standard or decorative bevel.

Pivot Cylinder

LUMINAIRE ID	HEIGHT	LIGHT SOURCE	BEAM	CRI	LUMEN PACKAGE ²		COLOR TEMP.
PIV1CY - Pivot 1.5" Cylinder PIV2CY - Pivot 2" Cylinder	6IN - 6" 9IN - 9" 12IN - 12" 18IN - 18"	SW - Static white FS - Full spectrum static white	20DEG - 20° Spot 35DEG - 35° Narrow flood 50DEG - 50° Wide flood	80CRI ¹ - 80+ CRI 90CRI ¹ - 90+ CRI 95CRI ¹ - 95+ CRI	1.5"	2"	27K - 2700K 30K - 3000K 35K - 3500K 40K - 4000K
					¹ Not available with full spectrum.	700LM - 700 lm, 9.4 W 850LM - 850 lm, 12.8 W	750LM - 750 lm, 11 W 900LM - 900 lm, 15.8 W

BAFFLE	BAFFLE FINISH ⁴	MODULE FINISH ⁵	TRACK ADAPTER FINISH ⁶	SUSPENSION	SUSPENSION LENGTH	CHANNEL POSITION ⁷
SDB - Standard baffle DCB ³ - Decorative baffle	FTMB - Matte black FTMW - Matte white CF# - Custom finish, specify RAL#	FTMB - Matte black FTMW - Matte white CF# - Custom finish, specify RAL#	FTMB - Matte black FTMW - Matte white CF# - Custom finish, specify RAL#	PCB - Black power cord PCW - White power cord	12IN - 12" 24IN - 24" 36IN - 36" 48IN - 48"	USC - Unified single channel DUC1 - Dual channel 1 DUC2 - Dual channel 2
³ Recommended when a different finish is desired for the baffle.	⁴ See page 30 for more finish options.	⁵ See page 30 for more finish options.	⁶ See page 30 for more finish options.			⁷ The channel position of each module must correspond to the channel option selected for the track. With USC, all modules will be controlled together. With DUC, specify either DUC1 or DUC2 for each module.

Photometrics

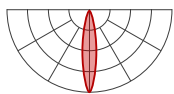

20DEG - 20° Spot

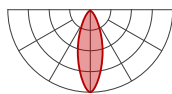

35DEG - 35° Narrow flood

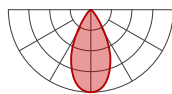

50DEG - 50° Wide flood

Module wattage (W)

SIZE	LUMEN PACKAGE at 3500K/80+ CRI	WATTAGE
1.5"	700	9.4 W
	850	12.8 W
2"	750	11 W
	900	15.8 W

Multiplier - CCT/CRI

CCT	Lumens		
	80+ CRI	90+ CRI	95+ CRI
2700K	0.94	0.77	0.72
3000K	0.96	0.82	0.75
3500K	1.00	0.85	0.81
4000K	1.02	0.87	0.79



PIVOT MODULE

STATIC WHITE, FULL SPECTRUM



Project: _____

Type: _____

Dimensions

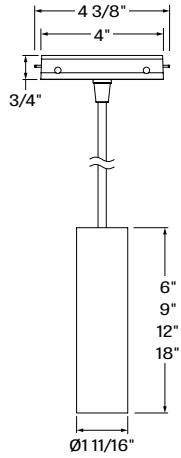

PIVICY - Pivot 1.5" Cylinder
- Standard baffle

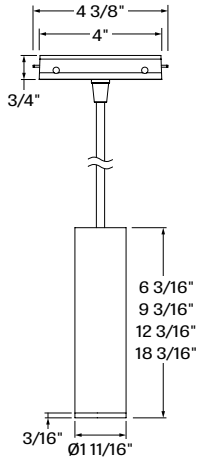

PIVICY - Pivot 1.5" Cylinder
- Decorative baffle

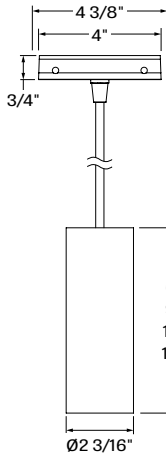

PIV2CY - Pivot 2" Cylinder
- Standard baffle

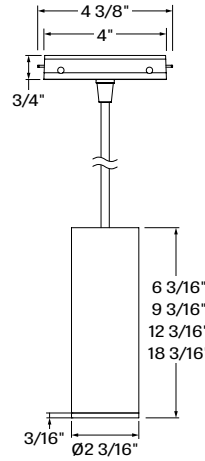

PIV2CY - Pivot 2" Cylinder
- Decorative baffle

SIZE	HEIGHT	WEIGHT	
1.5"	6"	0.88 lb	0.4 kg
	9"	0.99 lb	0.45 kg
	12"	1.1 lb	0.5 kg
2"	6"	1.43 lb	0.65 kg
	9"	1.43 lb	0.65 kg
	12"	1.54 lb	0.7 kg
	18"	1.87 lb	0.85 kg

PIVOT MODULE

STATIC WHITE, FULL SPECTRUM



Project: _____

Type: _____

PIVOT CELLA



DESCRIPTION

Pivot Cella brings clarity and rhythm to spaces through its vertical form. Available in 2" and 3" diameters, the slender luminaires are paired with acrylic diffusers offered in multiple heights and fully or partially frosted finishes, delivering visually comfortable illumination. Pivot Cella is suited to both accent applications and larger architectural installations, where repetition reinforces spatial organization and verticality.



Cella standalone

Cella

LUMINAIRE ID	DIFFUSER TYPE	DIFFUSER HEIGHT	LIGHT SOURCE	CRI	LUMEN PACKAGE	COLOR TEMP.				
			SW							
PIVCEL2 - Pivot Cella 2" PIVCEL3 - Pivot Cella 3"	FF - Fully frosted PF - Partially frosted	2IN - 2" 4IN - 4"	SW - Static white	80CRI - 80+ CRI 90CRI - 90+ CRI	<table border="1"> <tr> <td>Ø 2"</td> <td>450LM - 450 lm</td> </tr> <tr> <td>Ø 3"</td> <td>600LM - 600 lm</td> </tr> </table>	Ø 2"	450LM - 450 lm	Ø 3"	600LM - 600 lm	18K - 1800K 22K - 2200K 27K - 2700K 30K - 3000K 35K - 3500K 40K - 4000K 50K - 5000K
Ø 2"	450LM - 450 lm									
Ø 3"	600LM - 600 lm									

MODULE FINISH ¹	TRACK ADAPTER FINISH ²	SUSPENSION	SUSPENSION LENGTH	CHANNEL POSITION ³
FTMB - Matte black FTMW - Matte white FCHP - Champagne FDBZ - Dark bronze CF# - Custom finish, specify RAL# ¹ See page 30 for more finish options.	FTMB - Matte black FTMW - Matte white CF# - Custom finish, specify RAL# ² See page 30 for more finish options.	PCB - Black power cord PCW - White power cord	12IN - 12" 24IN - 24" 36IN - 36" 48IN - 48"	USC - Unified single channel DUC1 - Dual channel 1 DUC2 - Dual channel 2 ³ The channel position of each module must correspond to the channel option selected for the track. With USC, all modules will be controlled together. With DUC, specify either DUC1 or DUC2 for each module.

PIVOT MODULE

STATIC WHITE, FULL SPECTRUM



Project: _____

Type: _____

Dimensions

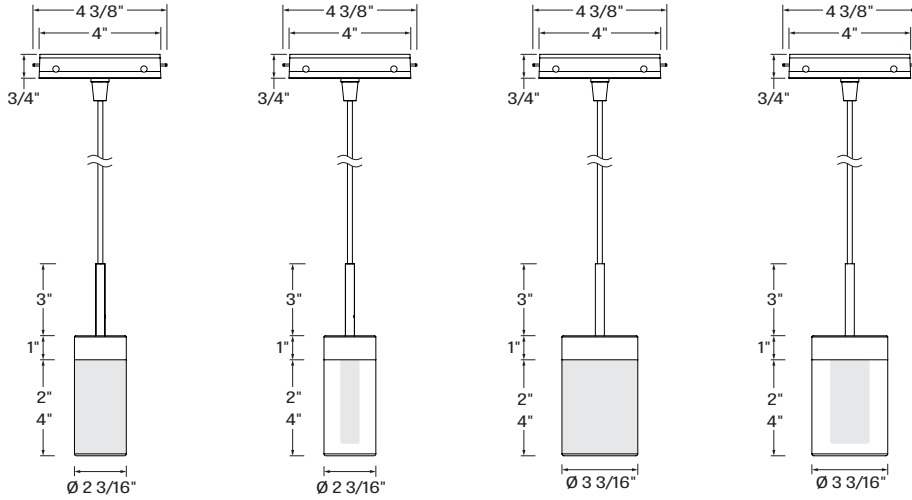

PIVCEL2 - Pivot Cella 2"
Fully frosted

PIVCEL2 - Pivot Cella 2"
Partially frosted

PIVCEL3 - Pivot Cella 3"
Fully frosted

PIVCEL3 - Pivot Cella 3"
Partially frosted

SIZE	HEIGHT	WEIGHT	
2"	Fully frosted		
	2"	0.4 lb	0.18 kg
	4"	0.5 lb	0.25 kg
	Partially frosted		
3"	Fully frosted		
	2"	0.8 lb	0.35 kg
	4"	1.1 lb	0.5 kg
	Partially frosted		
3"	Fully frosted		
	2"	1 lb	0.5 kg
	4"	1.5 lb	0.7 kg
	Partially frosted		

Photometrics

Module wattage (W)

SIZE	LUMEN PACKAGE at 3500K/80+ CRI	WATTAGE
2"	450	9.2 W
3"	600	9.2 W

Multiplier - CCT

CCT	Multiplier
1800K	1.19
2200K	1.07
2700K	1.02
3000K	1.00
3500K	1.00
4000K	0.97
5000K	0.97

PIVOT MODULE

STATIC WHITE, FULL SPECTRUM



Project: _____
 Type: _____

PIVOT OBE



DESCRIPTION

Pivot Obe luminaires are available in three models—Obe Opal, Obe Hex, and Obe Prism—each sharing the same curved shade profile while offering a distinct low-glare optical effect. Available in multiple shade sizes and premium brushed metallic finishes, Pivot Obe luminaires can be specified for intimate settings or arranged into larger decorative compositions.



Obe
standalone

Pivot Obe

LUMINAIRE ID	SIZE	SHADE FINISH ¹	MODULE FINISH
PIVOBE			
PIVOBE - Pivot Obe	8IN - Ø 8" shade with 2" module 12IN - Ø 12" shade with 3" module 18IN - Ø 18" shade with 4" module	FTMB - Matte black FTMW - Matte white CF# - Custom finish, specify RAL# <u>Premium colors</u> FBS - Brushed brass FCP - Brushed copper FBCH - Brushed champagne	FTMB - Matte black GLDA - Anodized gold

¹See page 30 for more finish options.

BAFFLE FINISH	OPTIC	LIGHT SOURCE	CRI	LUMEN PACKAGE	COLOR TEMP.
FTMB		SW			
FTMB - Matte black	HLO - High-Efficiency Lambertian Optic PMO - Precision Micro-Prism Optic HEX - Hex louver	SW - Static white	80CRI - 80+ CRI 90CRI - 90+ CRI	Ø 8" 300LM - 300 lm Ø 12" 600LM - 600 lm Ø 18" 800LM - 800 lm	18K - 1800K 22K - 2200K 27K - 2700K 30K - 3000K 35K - 3500K 40K - 4000K 50K - 5000K

TRACK ADAPTER FINISH ²	CORD GRIPPER ³	SUSPENSION	SUSPENSION LENGTH	CHANNEL POSITION ⁴
FTMB - Matte black FTMW - Matte white CF# - Custom finish, specify RAL# ² See page 30 for more finish options.	FTMB - Matte black FTMW - Matte white CF# - Custom finish, specify RAL# ³ See page 30 for more finish options.	PCB - Black power cord PCW - White power cord	12IN - 12" 24IN - 24" 36IN - 36" 48IN - 48"	USC - Unified single channel DUC1 - Dual channel 1 DUC2 - Dual channel 2 ⁴ The channel position of each module must correspond to the channel option selected for the track. With USC, all modules will be controlled together. With DUC, specify either DUC1 or DUC2 for each module.

PIVOT MODULE

STATIC WHITE, FULL SPECTRUM



Project: _____
 Type: _____

Dimensions

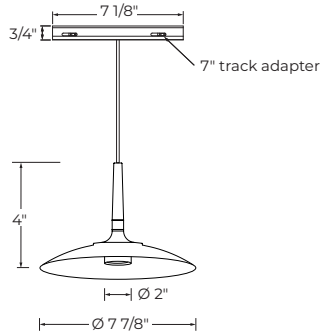

8IN - Ø 8"

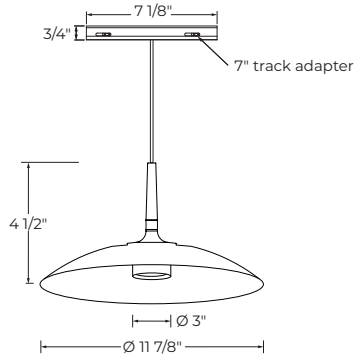

12IN - Ø 12"

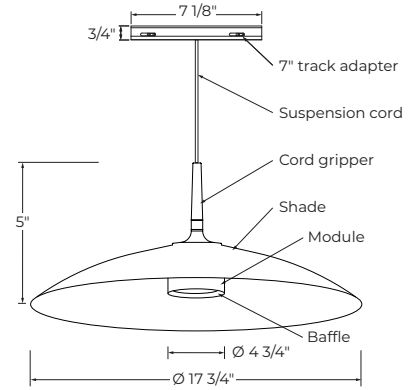

18IN - Ø 18"

Photometrics

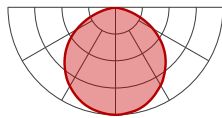

HLO

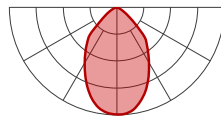

PMO

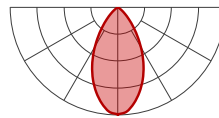

HEX

HLO - Module wattage (W)

SIZE	LUMEN PACKAGE at 3500K/80+ CRI	WATTAGE
Ø 8"	300	9.2
Ø 12"	600	16.4
Ø 18"	800	21.2

PMO - Module wattage (W)

SIZE	LUMEN PACKAGE at 3500K/80+ CRI	WATTAGE
Ø 8"	300	9.2
Ø 12"	600	11.6
Ø 18"	800	16.4

HEX - Module wattage (W)

SIZE	LUMEN PACKAGE at 3500K/80+ CRI	WATTAGE
Ø 8"	300	9.2
Ø 12"	600	16.4
Ø 18"	800	21.2

Multiplier - CCT

CCT	
1800K	1.19
2200K	1.07
2700K	1.02
3000K	1.00
3500K	1.00
4000K	0.97
5000K	0.97

PIVOT MODULE

STATIC WHITE, FULL SPECTRUM



Project: _____

Type: _____

PIVOT SHELL ROUND



DESCRIPTION

Pivot Shell Round is a sleek, well detailed, and remarkably versatile pendant able to deliver general illumination in working spaces as well as task lighting over conference tables, in break or lunch rooms, and above circulation spaces. It is equipped with our Unity Pointed (UP) technology, which delivers lens brightness uniformity across all shapes and sizes within the same lumen output.

Pivot Shell Round

LUMINAIRE ID	SIZE	OPTIC	LIGHT SOURCE	CRI	LUMEN PACKAGE ²		COLOR TEMP.
PIVSHER		HLO					
PIVSHER - Pivot Shell Round	8IN - Ø 8" 12IN - Ø 12"	HLO - High-Efficiency Lambertian Optic	SW - Static white FS - Full spectrum static white	80CRI ¹ - 80+ CRI 90CRI ¹ - 90+ CRI 95CRI - 95+ CRI	Ø 8" Ø 12"	700LM - 700 lm, 8.9 W 1600LM - 1600 lm, 19.4 W	27K - 2700K 30K - 3000K 35K - 3500K 40K - 4000K
				¹ Not available with full spectrum.	² Lumen outputs are reduced with full spectrum, consult factory.		

MODULE FINISH ³	TRACK ADAPTER FINISH ⁴	SUSPENSION	SUSPENSION LENGTH	CHANNEL POSITION ⁵
FTMB - Matte black FTMW - Matte white CF# - Custom finish, specify RAL#	FTMB - Matte black FTMW - Matte white CF# - Custom finish, specify RAL#	PCB - Black power cord PCW - White power cord	12IN - 12" 24IN - 24" 36IN - 36" 48IN - 48"	USC - Unified single channel DUC1 - Dual channel 1 DUC2 - Dual channel 2
³ See page 30 for more finish options.	⁴ See page 30 for more finish options.			⁵ The channel position of each module must correspond to the channel option selected for the track. With USC, all modules will be controlled together. With DUC, specify either DUC1 or DUC2 for each module.

Photometrics

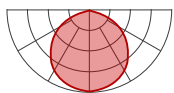

Module wattage (W)

SIZE	LUMEN PACKAGE at 3500K/80+ CRI	WATTAGE
8"	700	8.9 W
12"	1600	19.4 W

Multiplier - CCT/CRI

CCT	Lumens		
	80+ CRI	90+ CRI	95+ CRI
2700K	0.95	0.79	0.74
3000K	0.98	0.81	0.76
3500K	1.00	0.84	0.77
4000K	1.00	0.84	0.79

PIVOT MODULE

STATIC WHITE, FULL SPECTRUM



Project: _____

Type: _____

Dimensions

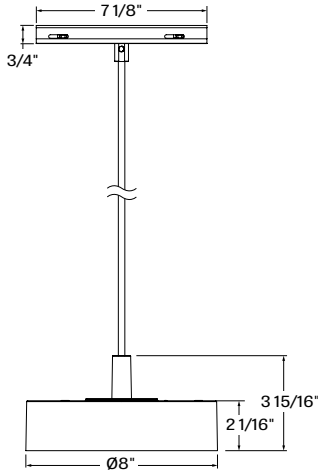

PIVSHER - Pivot Shell Round
Ø 8" with cable

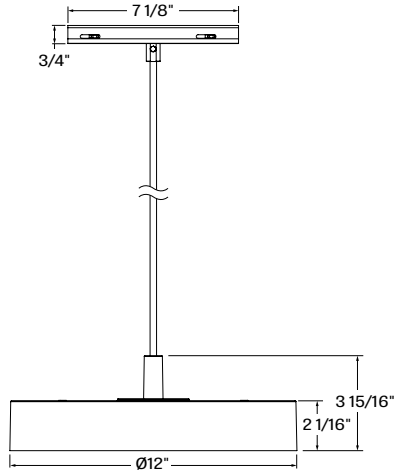

PIVSHER - Pivot Shell Round
Ø 12" with cable

SIZE	WEIGHT	
8"	2.42 lb	1.1 kg
12"	3.96 lb	1.8 kg

PIVOT MODULE

STATIC WHITE, FULL SPECTRUM



Project: _____
 Type: _____

PIVOT CARET



DESCRIPTION

Timeless in appearance and flexible in function, the conical Pivot Caret is a decorative pendant embodying the simple beauty of geometric design and the sophisticated power of innovative technology. It is equipped with our Unity Pointed (UP) technology, which delivers lens brightness uniformity across all shapes and sizes within the same lumen output.

Pivot Caret

LUMINAIRE ID	SIZE	OPTIC	LIGHT SOURCE	CRI	LUMEN PACKAGE ²		COLOR TEMP.
PIVCAR		HLO					
PIVCAR - Pivot Caret	8IN - Ø 8" 12IN - Ø 12"	HLO - High-Efficiency Lambertian Optic	SW - Static white FS - Full spectrum static white	80CRI ¹ - 80+ CRI 90CRI ¹ - 90+ CRI 95CRI - 95+ CRI	Ø 8" 700LM - 700 lm, 8.9 W Ø 12" 1600LM - 1600 lm, 19.4 W	27K - 2700K 30K - 3000K 35K - 3500K 40K - 4000K	
				¹ Not available with full spectrum.	² Lumen outputs are reduced with full spectrum, consult factory.		

INNER TRIM FINISH ³	MODULE FINISH ⁴	TRACK ADAPTER FINISH ⁵	SUSPENSION	SUSPENSION LENGTH	CHANNEL POSITION ⁶
FTMB - Matte black FTMW - Matte white CF# - Custom finish, specify RAL#	FTMB - Matte black FTMW - Matte white CF# - Custom finish, specify RAL#	FTMB - Matte black FTMW - Matte white CF# - Custom finish, specify RAL#	PCB - Black power cord PCW - White power cord	12IN - 12" 24IN - 24" 36IN - 36" 48IN - 48"	USC - Unified single channel DUC1 - Dual channel 1 DUC2 - Dual channel 2
³ See page 30 for more finish options.	⁴ See page 30 for more finish options.	⁵ See page 30 for more finish options.			⁶ The channel position of each module must correspond to the channel option selected for the track. With USC, all modules will be controlled together. With DUC, specify either DUC1 or DUC2 for each module.

Photometrics

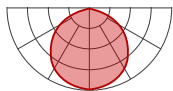

Module wattage (W)

SIZE	LUMEN PACKAGE at 3500K/80+ CRI	WATTAGE
8"	700	8.9 W
12"	1600	19.4 W

Multiplier - CCT/CRI

CCT	Lumens		
	80+ CRI	90+ CRI	95+ CRI
2700K	0.95	0.79	0.74
3000K	0.98	0.81	0.76
3500K	1.00	0.84	0.77
4000K	1.00	0.84	0.79

PIVOT MODULE

STATIC WHITE, FULL SPECTRUM



Project: _____

Type: _____

Dimensions

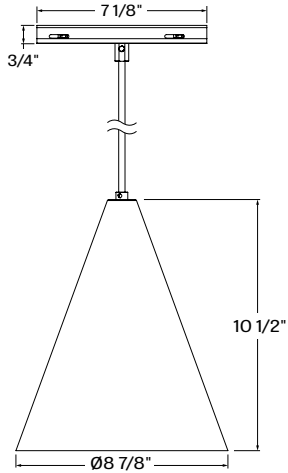

PIVCAR - Pivot Caret
Ø 8" with cable

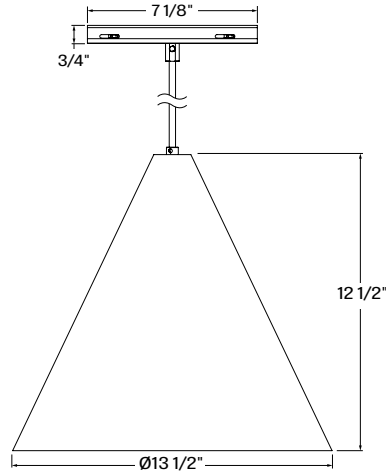

PIVCAR - Pivot Caret
Ø 12" with cable

SIZE	WEIGHT	
8"	3.08 lb	1.4 kg
12"	6.17 lb	2.8 kg

PIVOT MODULE

STATIC WHITE, FULL SPECTRUM



Project: _____
 Type: _____

PIVOT CUPOLA



DESCRIPTION

Timeless in appearance and flexible in function, the hemisphere Pivot Cupola is a decorative pendant embodying the simple beauty of geometric design and the sophisticated power of innovative technology. It is equipped with our Unity Pointed (UP) technology, which delivers lens brightness uniformity across all shapes and sizes within the same lumen output.

Pivot Cupola

LUMINAIRE ID	SIZE	OPTIC	LIGHT SOURCE	CRI	LUMEN PACKAGE ²	COLOR TEMP.
PIVCUP		HLO				
PIVCUP - Pivot Cupola	8IN - Ø 8" 12IN - Ø 12"	HLO - High-Efficiency Lambertian Optic	SW - Static white FS - Full spectrum static white	80CRI ¹ - 80+ CRI 90CRI ¹ - 90+ CRI 95CRI - 95+ CRI	Ø 8" 700LM - 700 lm, 8.9 W Ø 12" 1600LM - 1600 lm, 19.4 W	27K - 2700K 30K - 3000K 35K - 3500K 40K - 4000K

¹Not available with full spectrum. ² Lumen outputs are reduced with full spectrum, consult factory.

INNER TRIM FINISH ³	MODULE FINISH ⁴	TRACK ADAPTER FINISH ⁵	SUSPENSION	SUSPENSION LENGTH	CHANNEL POSITION ⁶
FTMB - Matte black FTMW - Matte white CF# - Custom finish, specify RAL# ³ See page 30 for more finish options.	FTMB - Matte black FTMW - Matte white CF# - Custom finish, specify RAL# ⁴ See page 30 for more finish options.	FTMB - Matte black FTMW - Matte white CF# - Custom finish, specify RAL# ⁵ See page 30 for more finish options.	PCB - Black power cord PCW - White power cord	12IN - 12" 24IN - 24" 36IN - 36" 48IN - 48"	USC - Unified single channel DUC1 - Dual channel 1 DUC2 - Dual channel 2 ⁶ The channel position of each module must correspond to the channel option selected for the track. With USC, all modules will be controlled together. With DUC, specify either DUC1 or DUC2 for each module.

Photometrics

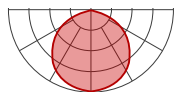

Module wattage (W)

SIZE	LUMEN PACKAGE at 35K/80+ CRI	WATTAGE
8"	700	8.9 W
12"	1600	19.4 W

Multiplier - CCT/CRI

CCT	Lumens		
	80+ CRI	90+ CRI	95+ CRI
2700K	0.95	0.79	0.74
3000K	0.98	0.81	0.76
3500K	1.00	0.84	0.77
4000K	1.00	0.84	0.79

PIVOT MODULE

STATIC WHITE, FULL SPECTRUM



Project: _____

Type: _____

Dimensions

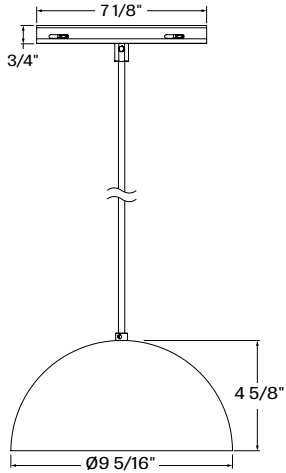

PIVCUP - Pivot Cupola
Ø 8" with cable

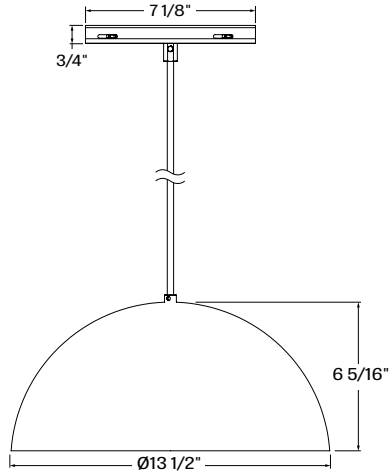

PIVCUP - Pivot Cupola
Ø 12" with cable

SIZE	WEIGHT	
8"	2.86 lb	1.3 kg
12"	5.73 lb	2.6 kg

PIVOT MODULE

STATIC WHITE, FULL SPECTRUM



Project: _____
 Type: _____

PIVOT TOTE



DESCRIPTION

Timeless in appearance and flexible in function, the truncated-cone-shaped Pivot Tote is a decorative pendant embodying the simple beauty of geometric design and the sophisticated power of innovative technology. It is equipped with our Unity Pointed (UP) technology, which delivers lens brightness uniformity across all shapes and sizes within the same lumen output.

Pivot Tote

LUMINAIRE ID	SIZE	OPTIC	LIGHT SOURCE	CRI	LUMEN PACKAGE ²		COLOR TEMP.
PIVOT		HLO					
PIVOT - Pivot Tote	8IN - Ø 8" 12IN - Ø 12"	HLO - High-Efficiency Lambertian Optic	SW - Static white FS - Full spectrum static white	80CRI ¹ - 80+ CRI 90CRI ¹ - 90+ CRI 95CRI - 95+ CRI	Ø 8" 700LM - 700 lm, 8.9 W Ø 12" 1600LM - 1600 lm, 19.4 W	27K - 2700K 30K - 3000K 35K - 3500K 40K - 4000K	

¹Not available with full spectrum.

² Lumen outputs are reduced with full spectrum, consult factory.

INNER TRIM FINISH ³	MODULE FINISH ⁴	TRACK ADAPTER FINISH ⁵	SUSPENSION	SUSPENSION LENGTH	CHANNEL POSITION ⁶
FTMB - Matte black FTMW - Matte white CF# - Custom finish, specify RAL#	FTMB - Matte black FTMW - Matte white CF# - Custom finish, specify RAL#	FTMB - Matte black FTMW - Matte white CF# - Custom finish, specify RAL#	PCB - Black power cord PCW - White power cord	12IN - 12" 24IN - 24" 36IN - 36" 48IN - 48"	USC - Unified single channel DUC1 - Dual channel 1 DUC2 - Dual channel 2

³See page 30 for more finish options.

⁴See page 30 for more finish options.

⁵See page 30 for more finish options.

⁶The channel position of each module must correspond to the channel option selected for the track. With USC, all modules will be controlled together. With DUC, specify either DUC1 or DUC2 for each module.

Photometrics

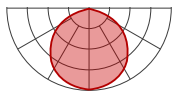

Module wattage (W)

SIZE	LUMEN PACKAGE at 3500K/80+ CRI	WATTAGE
8"	700	8.9 W
12"	1600	19.4 W

Multiplier - CCT/CRI

CCT	Lumens		
	80+ CRI	90+ CRI	95+ CRI
2700K	0.95	0.79	0.74
3000K	0.98	0.81	0.76
3500K	1.00	0.84	0.77
4000K	1.00	0.84	0.79



PIVOT MODULE

STATIC WHITE, FULL SPECTRUM



Project: _____

Type: _____

Dimensions

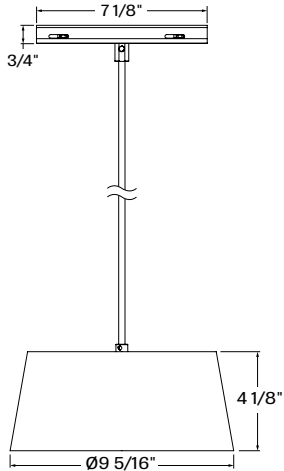

PIVOT - Pivot Tote
Ø 8" with cable

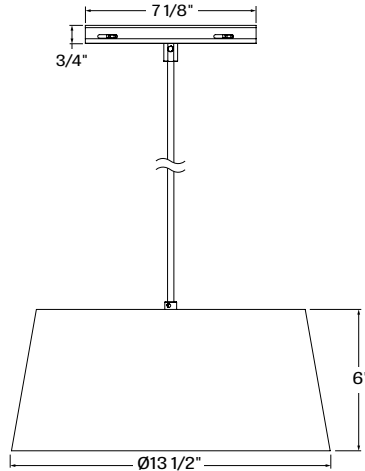

PIVOT - Pivot Tote
Ø 12" with cable

SIZE	WEIGHT	
8"	3.08 lb	1.4 kg
12"	6.61 lb	3 kg

PIVOT MODULE

STATIC WHITE



Project: _____
 Type: _____

PIVOT GLOBE

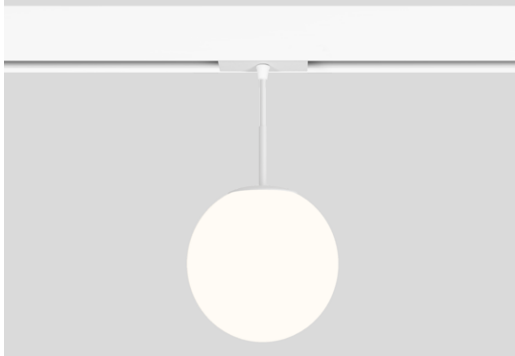

DESCRIPTION

Pivot Globe offers uniform light distribution and the timeless appeal of the spherical form. Made from frosted glass, the luminaire is lit fully with our Isotropic Radiant Optic™ (IRO™) that distributes light smoothly and evenly in all directions, thereby avoiding undesirable hotspots. Available in 4", 6", and 8" diameters.

Pivot Globe

LUMINAIRE ID	SIZE	OPTIC	LIGHT SOURCE	CRI	LUMEN PACKAGE						
PIVGLB		IRO	SW								
PIVGLB - Pivot Globe	4IN - Ø 4" 6IN - Ø 6" 8IN - Ø 8"	IRO - Isotropic Radiant Optic	SW - Static white	80CRI - 80+ CRI 90CRI - 90+ CRI 95CRI - 95+ CRI	<table border="1"> <tr> <td>Ø 4"</td> <td>300LM - 300 lm, 8 W</td> </tr> <tr> <td>Ø 6"</td> <td>600LM - 600 lm, 15 W</td> </tr> <tr> <td>Ø 8"</td> <td>900LM - 900 lm, 23 W</td> </tr> </table>	Ø 4"	300LM - 300 lm, 8 W	Ø 6"	600LM - 600 lm, 15 W	Ø 8"	900LM - 900 lm, 23 W
Ø 4"	300LM - 300 lm, 8 W										
Ø 6"	600LM - 600 lm, 15 W										
Ø 8"	900LM - 900 lm, 23 W										

COLOR TEMPERATURE	MODULE FINISH ¹	TRACK ADAPTER FINISH ²	SUSPENSION	SUSPENSION LENGTH	CHANNEL POSITION ³
27K - 2700K 30K - 3000K 35K - 3500K 40K - 4000K	FTMB - Matte black FTMW - Matte white CF# - Custom finish, specify RAL# ¹ See page 30 for more finish options.	FTMB - Matte black FTMW - Matte white CF# - Custom finish, specify RAL# ² See page 30 for more finish options.	PCB - Black power cord PCW - White power cord	12IN - 12" 24IN - 24" 36IN - 36" 48IN - 48"	USC - Unified single channel DUC1 - Dual channel 1 DUC2 - Dual channel 2 ³ The channel position of each module must correspond to the channel option selected for the track. With USC, all modules will be controlled together. With DUC, specify either DUC1 or DUC2 for each module.

Photometrics

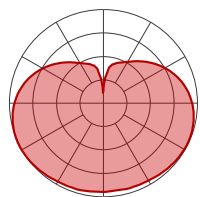

Dimensions

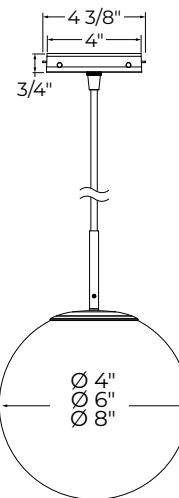

SIZE	WEIGHT	
4"	1.1 lb	0.5 kg
6"	1.8 lb	0.8 kg
8"	2.6 lb	1.2 kg

Module wattage (W)

SIZE	LUMEN PACKAGE at 3500K/80+ CRI	WATTAGE
4"	300	8 W
6"	600	15 W
8"	900	23 W

Multiplier - CCT/CRI

CCT	Lumens		
	80+ CRI	90+ CRI	95+ CRI
2700K	0.94	0.77	0.72
3000K	0.96	0.82	0.75
3500K	1.00	0.85	0.81
4000K	1.02	0.87	0.79

PIVOT MODULE



Project: _____
 Type: _____

PIVOT BLANK

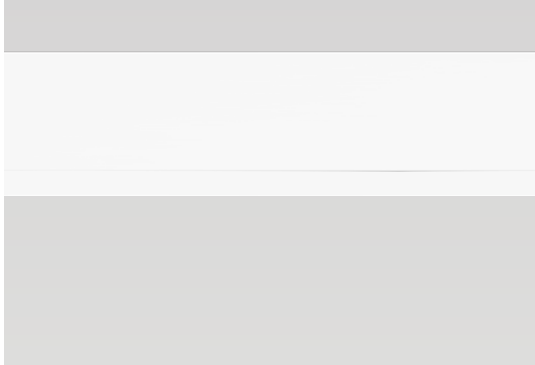

DESCRIPTION

Pivot Blank modules are unlit modules that click into the bottom of the Pivot Track system. Their purpose is to mask unlit track portions. Blank modules fit smoothly and securely to the track and are offered in 31 colors.

Pivot Blank

LUMINAIRE ID	MODULE TYPE	LENGTH		MODULE FINISH ⁴
PIVBLA				
PIVBLA - Pivot Blank	FAC ¹ - Factory-cut FIE ² - Field-cut ¹ Blank module is cut in factory to specified length, ready to be inserted in the track with pre-installed magnets. ² Blank module is cut on-site to desired length. Prior to inserting in the track, magnets must be installed, and ends must be modified if installing next to certain other modules.	FACTORY-CUT #FT#IN ³ - Specify nominal length (#) in 1' and/or 1" increments ³ Minimum length is 2', maximum length is 96".	FIELD-CUT 1FT - 1' 2FT - 2' 3FT - 3' 4FT - 4' 5FT - 5' 6FT - 6' 7FT - 7' 8FT - 8'	FTMB - Matte black FTMW - Matte white CF# - Custom finish, specify RAL# ⁴ See page 30 for more finish options.

Dimensions

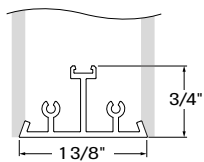

PIVBLA - Pivot Blank

LENGTH	WEIGHT	
	lb	kg
1'	0.29 lb	0.13 kg
2'	0.55 lb	0.25 kg
3'	0.84 lb	0.38 kg
4'	1.10 lb	0.50 kg
5'	1.39 lb	0.63 kg
6'	1.65 lb	0.75 kg
7'	1.94 lb	0.88 kg
8'	2.2 lb	1 kg

PIVOT MODULE

STATIC WHITE, FULL SPECTRUM



Finishes

Standard

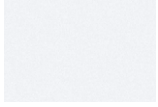

FTMW - Matte White



FTMB - Matte Black

Premium



FBS - Brushed brass



FCP - Brushed copper



FBCH - Brushed champagne



GLDA - Anodized Gold

Custom

Neutrals

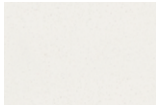

CRM - Cream



GRY - Gray



STG - Steel Gray



SAG - Sage Gray



BLB - Black Blue

Designer

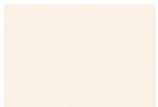

ALM - Almond



RST - Rust Fine Texture

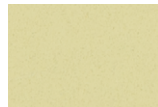

GRB - Green Beige



YLW - Yellow



SLM - Salmon Pink



VIO - Pastel Violet



RED - Red



PRR - Purple Red



SMB - Storm Blue



DPB - Deep Blue



OCB - Ocean Blue



BLG - Blue Green



GNS - Green Smoke



MNG - Mint Green

Metallics

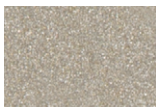

CHP - Champagne

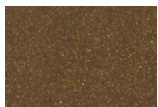

DBZ - Dark Bronze



CNY - Canyon

Premium Custom

Neutrals

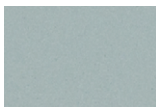

MOG - Moss Gray

Designer

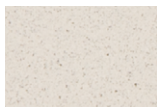

QRZ - Quartzite Texture

Metallics



LMG - Lime Green

Metallics



GLD - Gold

Metallics



IRN - Iron Ore

Metallics



SBP - Sandblast Copper

Metallics



SWD - Sandalwood Copper

Some colors may have longer lead time.

PIVOT MODULE

STATIC WHITE, FULL SPECTRUM



Technical Specifications

OPTICS

High-Efficiency Lambertian Optic (HLO)

Shielding of diffusing 0.075" thick acrylic provides up to 88% transmission and good obscuration. Matte white reflectors distribute LED output across the shielding. Luminaire brightness is controlled by the ratio of luminous flux to shielding area.

Wall Wash Optic (WW)

Wall Wash optics use multiple mid-flux emitters in a continuous array, supported by an angled board. An aluminum reflector collects and redirects emitter flux, while a refractive film adjusts both vertical and horizontal intensity and eliminates source image. The result is excellent uniformity up and down the wall, as well as between luminaires.

Soft-Edged Feathered Beam (SOF)

The Soft-Edged Feathered Beam blends the light into darker areas for a gentle brightness transition. Each LED emitter directs light through a single, custom molded circular optic using total internal reflection (TIR) to shape the light. A 0.5" reflective square louver provides a cut off with a UGR of 10. Three different TIR elements create a choice of beam spread: 25° narrow flood (NFL), 35° flood (FLD), or 55° wide flood (WFL).

Sharp-Edged Cut-Off Beam (REF)

The Sharp-Edged Cut-Off Beam creates dramatic impact, limiting the spread of light outside of the primary beam. A molded conical reflector redirects light from each emitter into the desired beam angle. A 0.5" reflective square louver provides a cut off with a UGR of 10. Three different TIR elements create a choice of beam spread: 15° spot (SPT), 30° flood (FLD), or 45° wide flood (WFL).

CircaFlex™ Optic

The Pivot Dot/Box/Cylinder CircaFlex™ Optic, at just 1.2", uses advanced beam-splitting technology to allow light to follow an intended optical path with maximal precision, minimal spread, and even distribution.

Isotropic Radiant Optic™ (IRO™)

The Isotropic Radiant Optic™ (IRO™) is a spherical lens designed with a spike-textured surface through which light rays are diffused outward and equally in all directions.

LIGHT SOURCE

Static white

LEDs are available in 2700K, 3000K, 3500K and 4000K with a choice of 80+ CRI, 90+ CRI, or 95+ CRI, with elevated R9 value for 90+ CRI and above. Color consistency is maintained to within 2 SDCM. All LEDs have been tested in accordance with IESNA LM-80-08 and the results have shown L80 lumen maintenance greater than 60,000 hours. Absolute product photometry is measured and presented in accordance with IESNA LM-79, unless otherwise indicated.

Full spectrum static white

The full spectrum LED option offers improved color particularly in the cyan region that is beneficial in both healthcare and circadian lighting strategies. The cyan region in full spectrum LED is richer at the 480 nm range.

WELL BUILDING STANDARD



WELL for Light: The WELL building standard focuses on light quality in several features. There are three categories that are fully attributed to the construction and features of a luminaire. In WELL V1, it's Feature 54 Circadian Lighting, Feature 55 Glare Control, and Feature 58 Color Quality. In WELL V2, it's Feature L03 Circadian Lighting, Feature L04 Glare Control, and Feature L07 Electric Light Quality.

This fixture meets Features:

- Feature 54 or L03 when full spectrum LED is selected
- Feature 58 or L07 when 90+ CRI or above is selected

All LED drivers used at Lumenwerx are deemed to have a low risk level of flicker, of 5% or less below 90Hz operational as defined by IEEE standard 1789-2015 LED.



WELL for Mind: This luminaire meets WELL for mind as it is a human centric luminaire offering quality light, excellent color, and smooth optics. If any of these features are incorporated in a luminaire, it can improve the ability to focus, concentrate, and persist longer on a given task. This fixture harmoniously operates in a space to assist the mind.

For more information, please contact well@lumenwerx.com

PIVOT MODULE

STATIC WHITE, FULL SPECTRUM



LOCKING MECHANISM

The Pivot module locking mechanisms are easy to use and ensure that each module is secured to the track.

There are three different types:

The V-Lock is activated with a simple push of a button located on the surface of the end cap adapter. To release the module, pull down the tab of the locking mechanism.

The H-Lock is activated automatically when the module is pushed in place. To release the module, simply push the two side buttons to remove from the track. A lockable H-Lock adapter is provided for modules specified with the emergency light section option.

The S-Lock is activated when the two slotted screws on the adapter are turned to lock in place. To release the module, simply turn the screws in the opposite direction to remove from the track.

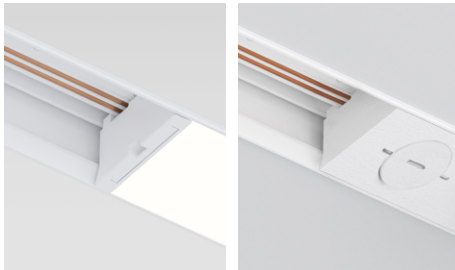

V-Lock

S-Lock

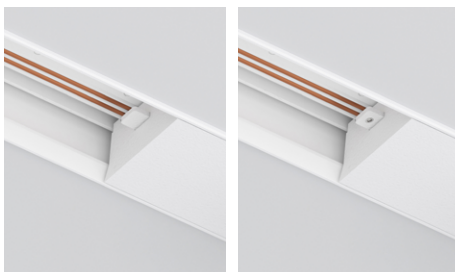

H-Lock

H-Lock -
emergency light section

CONSTRUCTION

Track adapter: Extruded aluminum, up to 90% recycled content

Module housing: Extruded aluminum, up to 90% recycled content

Reflectors: Cold rolled steel die formed, 95% reflective matte white painted

Diffuser

HLO: Extruded acrylic

WW: Extruded acrylic with optic overlay

Drop diffuser: Extruded with glued end caps

End caps: Die-cast aluminum

CERTIFICATION

ETL: Rated for indoor dry locations. Conforms to UL Standard 1574 and certified to CAN/CSA Standard C22.2 No. 250.0.

WARRANTY

Lumenwerx provides a five-year limited warranty on electrical and mechanical performance of the luminaires, including the LED boards, drivers, and auxiliary electronics. Lumenwerx will repair or replace defective luminaires or components at our discretion, provided they have been installed and operated in accordance with our specifications. Other limitations apply, please refer to the full warranty on our website.