

# PIVOT

TRACK - RECESSED



## DESCRIPTION

Pivot is an architectural 48V linear magnetic track lighting system for recessed mounting. The Recessed Track is low voltage and accommodates the Pivot Track Modules. It possesses infinite run capabilities in segments of up to 8' with smooth transitions at the joint. It can also be branched out horizontally and vertically to create a multitude of shapes, patterns, and effects for various architectural applications. The Track is offered in different circuit and control channel variations.

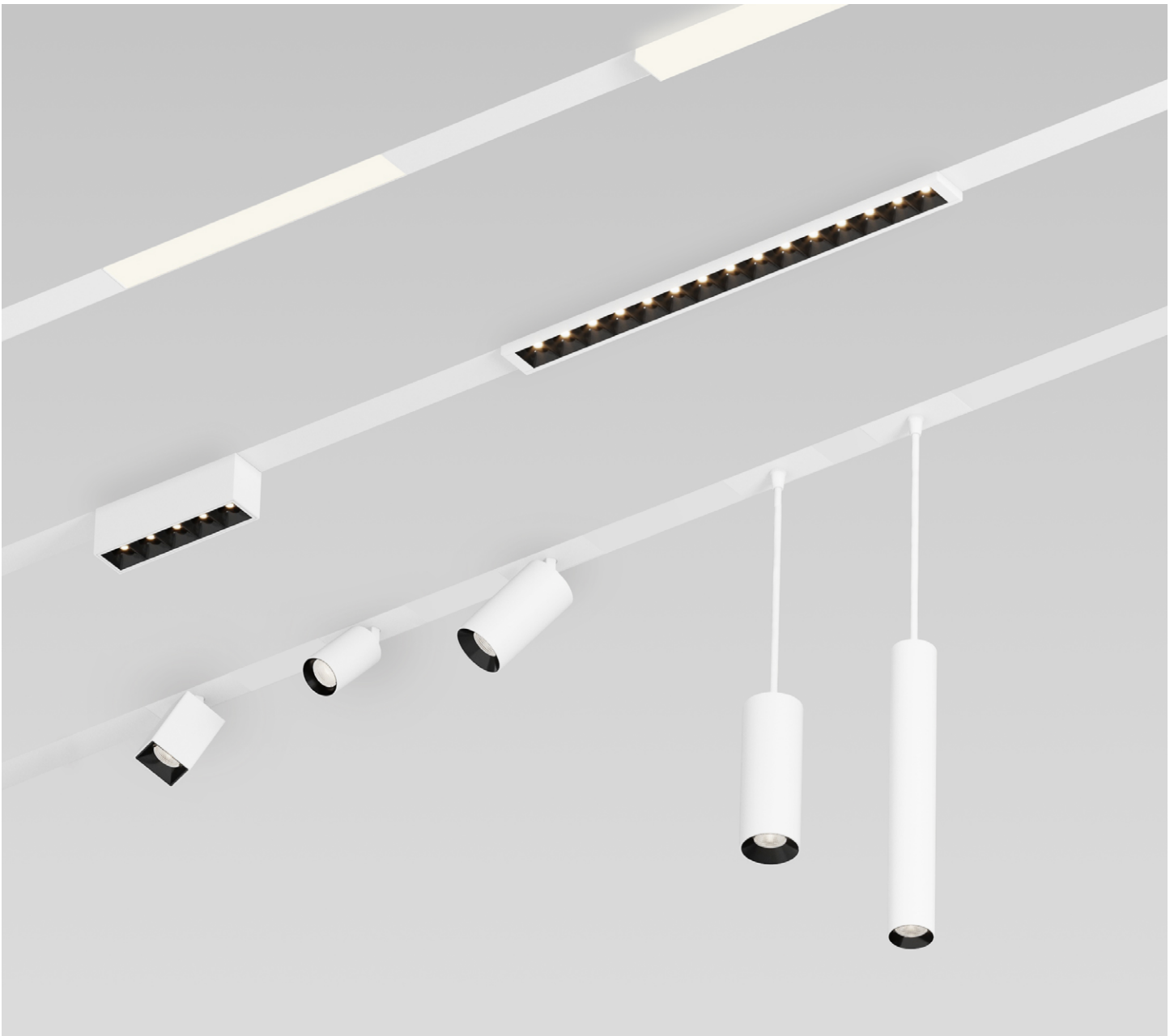

Project: \_\_\_\_\_

Type: \_\_\_\_\_

### Track

Example: PIVRLIN-9FT6IN(2X3FT-1X3FT6IN)-NA-120V-D1-USC-1C1CCUD-NA-DMF-FTMB-BK-NA

A drawing of your pattern is required - anything from a line drawing to an architectural drawing. You can also use the grid on page 3 to sketch your layout.

LUMINAIRE ID	LUMINAIRE LENGTH <sup>3</sup>	CORNER TYPE <sup>4,5</sup>
<b>PIVRLIN</b> <sup>1</sup> - Pivot Recessed Linear <b>PIVRPAT</b> <sup>2</sup> - Pivot Recessed Pattern  <sup>1</sup> A straight continuous run with no corners. <sup>2</sup> A shape or pattern containing at least 1 corner.	<b>##FT##IN</b> <b>(#X#FT#IN-#X#FT#IN-...)</b> -  <b>##FT##IN</b> : total nominal length of continuous run or pattern in feet and/or inches (2' or longer) <b>#X</b> : quantity of each section <b>#FT#IN</b> : nominal length of each section in feet and/or inches, specify between 2' and 8'  <sup>3</sup> Consult the Maximum Track Wattage table on page 3 to determine the maximum load allowed per section.	<b>#LEVC90</b> <sup>6</sup> - Leveled 90° corner in ceiling <b>#INN90</b> - Inside 90° corner <b>NA</b> - None  <sup>4</sup> Specify number of corners (#) for each required corner type. <sup>5</sup> If more than one option is specified, separate codes with a "+", e.g. 2LEVC90+1INN90 <sup>6</sup> Consult factory for other degree angles.

VOLTAGE	DIMMING	TRACK CHANNEL	CONTROL CHANNEL <sup>10</sup>	EMERGENCY SECTION
<b>120V</b> - 120V <b>277V</b> - 277V <b>UNV</b> - 120V-277V	<b>ND</b> - Non-dimming <b>D1</b> - 1% 0-10V <b>DA</b> <sup>7</sup> - DALI <b>LECS</b> <sup>7,8,9</sup> - Lutron EcoSystem  <sup>7</sup> On-site commissioning is required. See page 5 for details. <sup>8</sup> Only available with USC, 1 circuit, and 1 control channel option (1C1CCUD). <sup>9</sup> Comes with a control box that must be installed remotely.	<b>USC</b> - Unified single channel <b>DUC</b> - Dual channel	<b>1C1CCUD</b> - 1 circuit, 1 control channel (USC) <b>1C2CCDD</b> - 1 circuit, 2 control channels (DUC channel 1 - DUC channel 2) <b>2C2CCDD</b> - 2 circuits, 2 control channels (DUC channel 1 - DUC channel 2)  <sup>10</sup> For more details, please see the circuit and channel specification below.	<b>EC</b> <sup>11</sup> - Emergency light section <b>NA</b> - None  <sup>11</sup> Consult factory.

MOUNTING	OUTSIDE FINISH <sup>12</sup>	INSIDE FINISH	OPTIONS <sup>13</sup>
<b>GRD</b> - Grid ceiling <b>DMF</b> - Drywall mud flange	<b>FTMB</b> - Matte black <b>FTMW</b> - Matte white <b>CF#</b> - Custom finish, specify RAL#  <sup>12</sup> See page 4 for more finish options.	<b>BK</b> - Black <b>WH</b> - White	<b>FU120</b> - Fuse 120V <b>FU277</b> - Fuse 277V <b>CP</b> - Chicago Plenum <b>NA</b> - None  <sup>13</sup> Separate codes with a "*" if more than one is specified.

### Dimensions

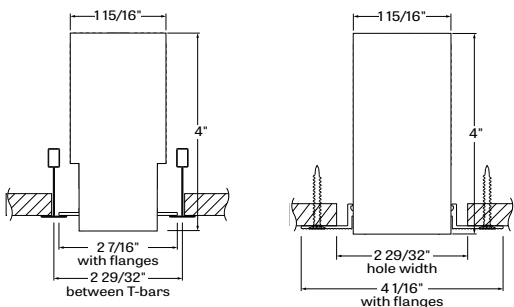

### Circuit and channel specification

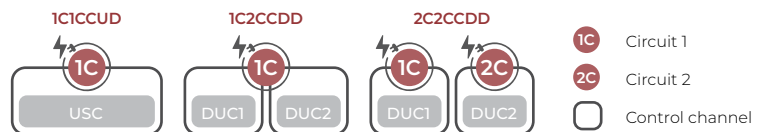

### CURRENT LIMITER

The Pivot Track system is based on a low-voltage (48 VDC) design that integrates the AC/DC conversion inside the body of the track (except for Surface). The AC/DC 48V power supplies inside the fixture are inherently limited to specific wattages intended to provide at least 12 W/ft. Accordingly, if a track section is overloaded with modules, the system can never draw more than the rating of the power supply inside. In situations where the wattage of the modules installed exceeds the rated wattage of the integral power supply, flashing will typically occur to indicate an overload event.

Project: \_\_\_\_\_

Type: \_\_\_\_\_

### Track Details

Use the grid below to sketch and label the layout of your Pivot Track.

- Build your continuous run or pattern using track sections of 2' to 8'.
- The total wattage of all the modules installed in a track section must not exceed the maximum track wattage per section length (see table). Consult the Pivot Module spec sheet for the wattages of each module.
- Corners are unlit with 6" x 6" blanks.
- Track length is not field adjustable.

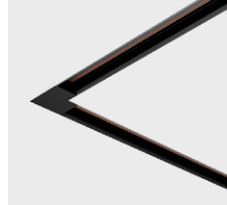

**LEVC90**  
- Leveled 90° corner in ceiling



**INN90**  
- Inside 90° corner

#### Maximum Track Wattage \*

at 3500K at 80+ CRI

**! Do not exceed the maximum wattage allowed per section of track.**

LENGTH	USC	DUC	
		Channel 1	Channel 2
2'	24 W	12 W	12 W
3'	36 W	18 W	18 W
4'	48 W	24 W	24 W
5'	60 W	30 W	30 W
6'	72 W	36 W	36 W
7'	84 W	42 W	42 W
8'	96 W	48 W	48 W

\* To determine the maximum wattage allowed per section of track, multiply the length of your section by 12 W/ft.

#### Maximum Track Length

##### Per Power Feed \*

VOLTAGE	LENGTH
120V	60'
277V	140'

\* Assuming 12 W/ft, track with 1 circuit (ICICCU or IC2CCUD). For other scenarios, consult factory.

#### Pattern example

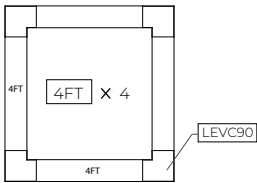

1. Specify the **TOTAL LUMINAIRE LENGTH** in feet and/or inches.

Example: 16FT(4X4FT)

2. Specify the quantity of each **CORNER TYPE**.

Example: 4LEVC90

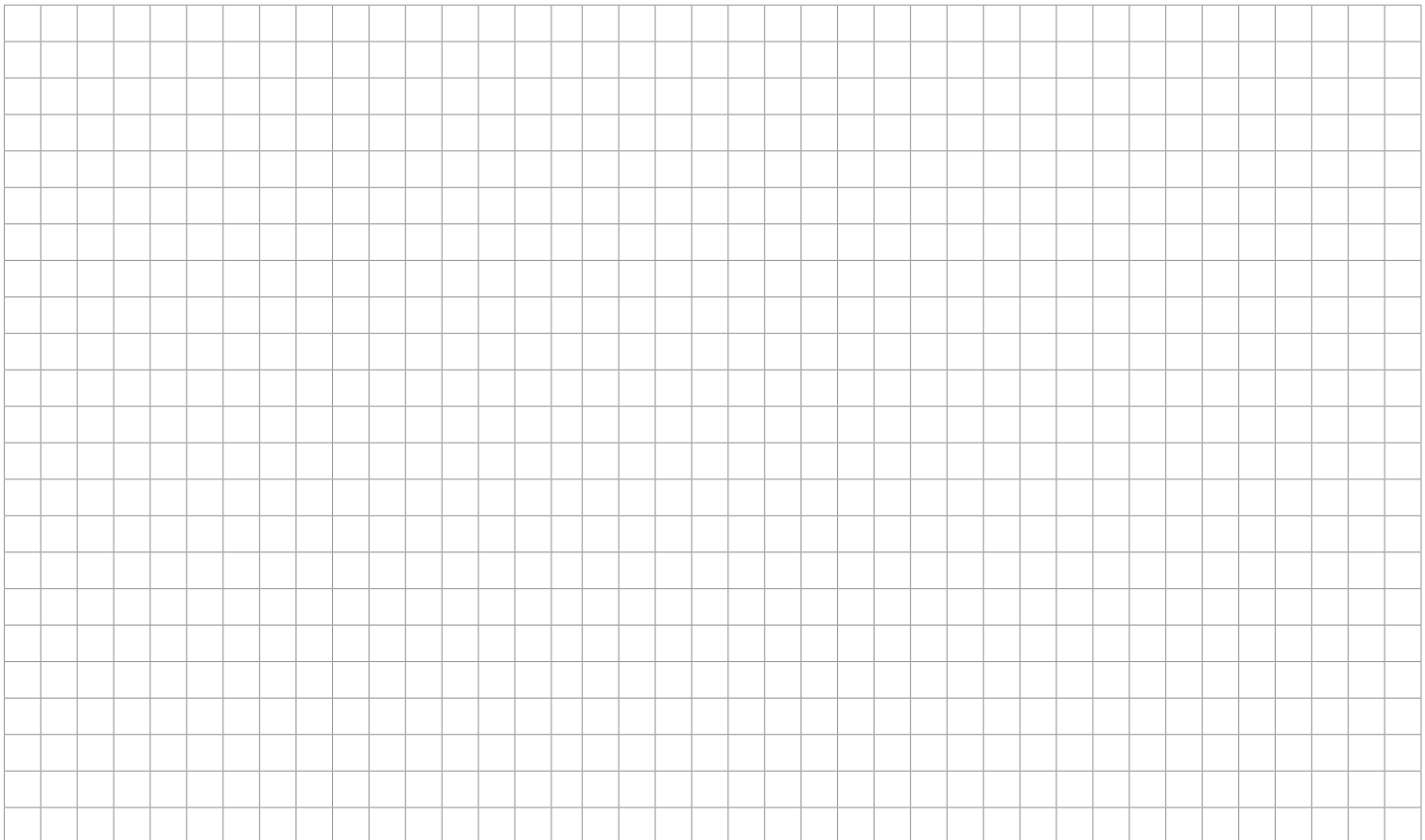

### Finishes

#### Standard

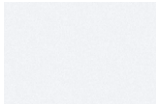

**FTMW** - Matte White



**FTMB** - Matte Black

#### Custom

##### Neutrals

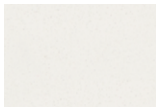

**CRM** - Cream



**GRY** - Gray



**STG** - Steel Gray



**SAG** - Sage Gray



**BLB** - Black Blue

##### Designer

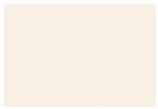

**ALM** - Almond



**RST** - Rust Fine  
Texture



**GRB** - Green Beige



**YLW** - Yellow



**SLM** - Salmon Pink



**VIO** - Pastel Violet



**RED** - Red



**PRR** - Purple Red



**SMB** - Storm Blue



**DPB** - Deep Blue



**OCB** - Ocean Blue



**BLG** - Blue Green



**GNS** - Green Smoke



**MNG** - Mint Green

##### Metallics



**CHP** - Champagne



**DBZ** - Dark Bronze



**CNY** - Canyon

#### Premium Custom

##### Neutrals



**MOG** - Moss Gray

##### Designer

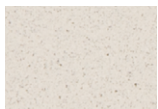

**QRZ** - Quartzite  
Texture

##### Metallics



**LMG** - Lime Green

##### Metallics



**GLD** - Gold

##### Metallics



**IRN** - Iron Ore

##### Metallics



**SBP** - Sandblast  
Copper

##### Metallics



**SWD** - Sandalwood

Some colors may have longer lead time.

### Technical Specifications

#### LUMINAIRE LENGTH

Pivot Track is available either as a continuous run (straight linear shape with no corners) or as a pattern containing at least 1 corner. It is built using track sections of 2' to 8'. The total nominal length must be specified in the product code, as well as the quantity and nominal length of each section. Lengths can be ordered in 1' increments. The track length is not field adjustable.

All individual sections are joined together onsite using the joiner kits provided. Lumenwerx offers joiner kits that are extremely simple to work with in the field and result in a fixture that appears virtually seamless with no light leak at any connection.



#### ELECTRICAL

The Pivot Track is powered by an integral (except for Surface) 48 VDC, Class 2, SELV power supply with universal (120-277 VAC) input. Rated lifetime of 50,000 hours at 50°C max. ambient (and 70°C max. case) temperature. At maximum driver load: Efficiency > 90%, PF > 0.9, THD < 20%. The power supply is coupled to a proprietary dimming interface which allows one or both track channels to be controlled together or independently using a 0-10V or DALI signal. Both the power supply and the dimming interface can be serviced from below. For applications requiring Lutron Ecosystem control, a separate, remote interface can be provided to translate Ecosystem to 0-10V.

#### DALI

A maximum of 64 DALI devices is permitted on a single DALI line. Please note that each Pivot track section consists of a minimum of 2 DALI devices with the possibility of up to 4 DALI devices depending on control channel and circuit selection. Please consult factory for additional details.

#### MOUNTING

Recessed fixtures can be mounted into exposed or concealed T-bar or tegular ceiling, as well as in drywall ceilings/walls.

#### FINISH

**Outside:** Standard powder-coat paint available in matte white and black. Custom colors are also available in over 30 colors.

**Inside:** White or black

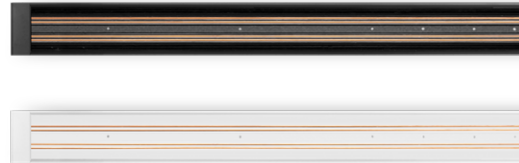

#### CONSTRUCTION

**Track housing:** Extruded aluminum, up to 90% recycled content

**Joining system:** Die-cast zinc

**Blank cover:** Extruded aluminum

**End plate:** Aluminum sheet

#### WEIGHT

**2':** 5.5 lbs - 2.5 kg

**4':** 9.9 lbs - 4.5 kg

**6':** 14.6 lbs - 6.6 kg

**8':** 19.4 lbs - 8.8 kg

#### CERTIFICATIONS

**ETL:** Rated for indoor dry locations. Conforms to UL Standard 1574 and certified to CAN/CSA Standard C22.2 No. 250.0.

**Chicago Plenum:** City of Chicago Approved (CCEA) when specified with CP option.

#### WARRANTY

Lumenwerx provides a five-year limited warranty on electrical and mechanical performance of the luminaires, including the LED boards, drivers, and auxiliary electronics. Lumenwerx will repair or replace defective luminaires or components at our discretion, provided they have been installed and operated in accordance with our specifications. Other limitations apply, please refer to the full warranty on our website.