

POP ECHOCORE ROUND

SURFACE
STATIC WHITE, FULL SPECTRUM



Pop Echocore™ acoustic luminaires not only offer lens brightness uniformity enabled by our Unity Pointed (UP) technology, but they also reduce echo and reverberation in their immediate environment. When sound waves meet the lighting fixture, they pass through its aluminum lattice only to be trapped by its core of layered sound-absorbing material. Available in round and square models with pendant, surface, and recessed mounting options.

Patterns

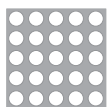

Round

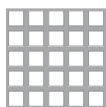

Square



Linear

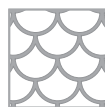

Scallop



Cubic

POP ECHOCORE ROUND



SURFACE
STATIC WHITE, FULL SPECTRUM

Project: _____

Type: _____

Luminaire code

LUMINAIRE ID	SIZE	DISTRIBUTION	OPTIC	LENS POSITION	LIGHT SOURCE ¹
POECHROS		D	ULO		
POECHROS - Pop Echocore Round Surface	24IN - Ø 24" 36IN - Ø 36" 48IN - Ø 48"	D - Direct	ULO - Uniform Lambertian Optic	FH - Flush 0.5D - 0.5" drop 1D - 1" drop	SW - Static white FS - Full spectrum ¹ Chromawerx SOLA, DUO, and QUADRO also available. Consult factory.

CRI	DIRECT LUMEN PACKAGE			COLOR TEMP.	VOLTAGE	DRIVER ⁷	ELECTRICAL	MOUNTING	
							1C	SUR	
80CRI ² - 80 CRI 90CRI ² - 90 CRI 95CRI ³ - 95 CRI	Ø 24" Ø 36" Ø 48"	Low 750LM	Med ⁴ 900LM	High ⁴ 1100LM	27K - 2700K 30K - 3000K 35K - 3500K 40K - 4000K	120V - 120V 277V - 277V UNV - 120V-277V 347V ^{5,6} - 347V	D1 - 1% 0-10V DA ⁸ - DALI LDE1 ⁸ - Lutron Hi-lume 1% Eco ELD1 - eldoLED 1% ECOdrive 0-10V ELD0 - eldoLED 0.1% SOLOdrive 0-10V ELV ⁹ - ELV 120V TRI ⁹ - TRIAC 120V	1C - 1 circuit	SUR - Surface
² Not available with full spectrum. ³ Not available with static white. ⁴ Not available with full spectrum.					⁵ Available with D1 only. ⁶ Driver is remote.	⁷ PoE (Power-over-Ethernet) compatible. Consult factory for details. ⁸ On-site commissioning is required. ⁹ Available with 120V only.			

FIXTURE FINISH	PATTERN	PATTERN FINISH	FELT COLOR	OPTION
W - Matte white AL - Aluminum B - Matte black CF# - Custom finish, specify RAL# See page 3 for more finish options.	STANDARD ROU - Round SQU - Square LIN - Linear PREMIUM SCP - Scallop CBC - Cubic	W - Matte white AL - Aluminum B - Matte black CF# - Custom finish, specify RAL# See page 3 for more finish options.	STANDARD COLORS FWN LVN FON LEN ION CYN TBN PMN MDN FGN PREMIUM COLORS ¹⁰ PKN CDN IVN BHN OGN LCN SLN CFN LNN SYN CNN GRN LMN BLN GHN MON EGN NVN CLN ESN	FU120 - Fuse 120V FU277 - Fuse 277V NA - None
			¹⁰ Please consult factory for more color options. Lead time may vary.	

Blank code

LUMINAIRE ID	SIZE	MOUNTING	FIXTURE FINISH	PATTERN	PATTERN FINISH	FELT COLOR
POECHROBS		SUR				
POECHROBS - Pop Echocore Round Blank Surface	24IN - Ø 24" 36IN - Ø 36" 48IN - Ø 48"	SUR - Surface	W - Matte white AL - Aluminum B - Matte black CF# - Custom finish, specify RAL# See page 3 for more finish options.	STANDARD ROU - Round SQU - Square LIN - Linear PREMIUM SCP - Scallop CBC - Cubic	W - Matte white AL - Aluminum B - Matte black CF# - Custom finish, specify RAL# See page 3 for more finish options.	STANDARD COLORS FWN LVN FON LEN ION CYN TBN PMN MDN FGN PREMIUM COLORS ¹¹ PKN CDN IVN BHN OGN LCN SLN CFN LNN SYN CNN GRN LMN BLN GHN MON EGN NVN CLN ESN
						¹¹ Please consult factory for more color options. Lead time may vary.

POP ECHOCORE ROUND



SURFACE
STATIC WHITE, FULL SPECTRUM

Fixture/Pattern Finishes

Standard

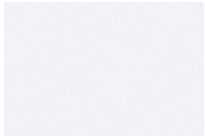

W - Matte White



AL - Aluminum



B - Matte Black

Custom

Neutrals

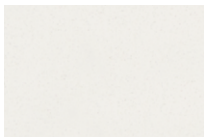

CRM - Cream



GRY - Gray

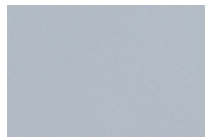

STG - Steel Gray



SAG - Sage Gray



MOG - Moss Gray



BLB - Black Blue

Designer

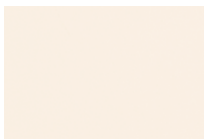

ALM - Almond



QRZ - Quartzite Texture



RST - Rust Fine Texture

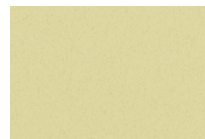

GRB - Green Beige



YLW - Yellow



SLM - Salmon Pink

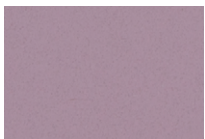

VIO - Pastel Violet



RED - Red



PRR - Purple Red



SMB - Storm Blue



DPB - Deep Blue



OCB - Ocean Blue

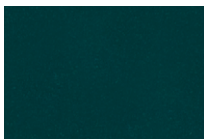

BLG - Blue Green



GNS - Green Smoke



MNG - Mint Green



LMG - Lime Green

Metallics



CHP - Champagne



GLD - Gold

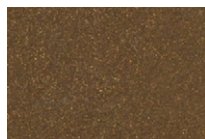

DBZ - Dark Bronze



IRN - Iron Ore



CNY - Canyon



SBP - Sandblast Copper



SWD - Sandalwood

POP ECHOCORE ROUND



SURFACE
STATIC WHITE, FULL SPECTRUM

Felt Finishes

Standard Color Options



FWN - FROST WHITE

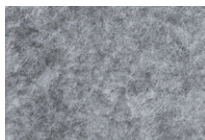

FON - FOG



ION - IRON

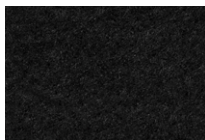

TBN - TRUE BLACK

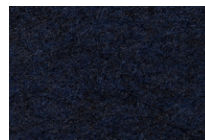

MDN - MIDNIGHT BLUE



LVN - LAVENDER

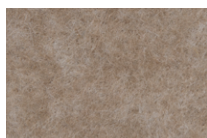

LEN - LATTE



CYN - CHERRY

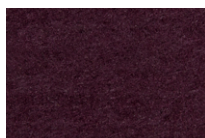

PMN - PLUM

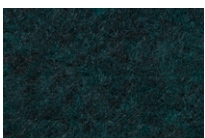

FGN - FOREST GREEN

Premium Color Options*

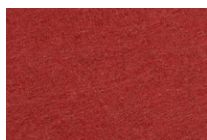

PKN - PAPIKA



OGN - ORANGE



LNN - LEMON



LMN - LIME

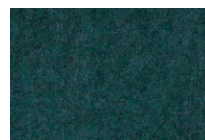

EGN - EVERGREEN



CDN - CLOUDY



LCN - LICHEN



SYN - SKY

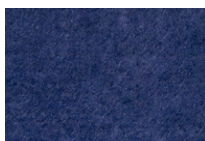

BLN - BLUEBERRY

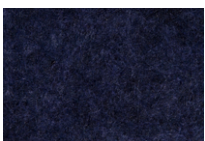

NVN - NAVY

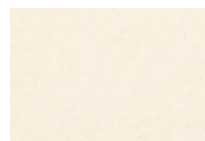

IVN - IVORY

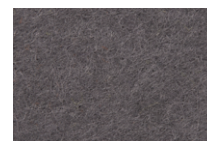

SLN - STEEL

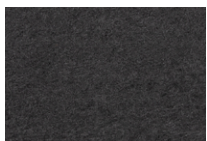

CNN - CARBON

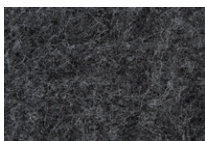

GHN - GRAPHITE

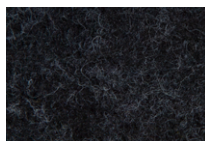

CLN - CHARCOAL



BHN - BLUSH



CFN - CAFÉ



GRN - GREIGE

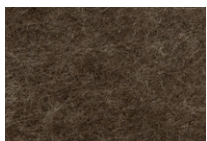

MON - MOCHA

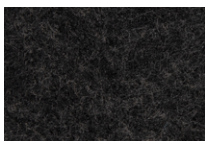

ESN - ESPRESSO

*Please consult factory for more color options.

*Lead time may vary.

POP ECHOCORE ROUND



SURFACE
STATIC WHITE, FULL SPECTRUM

Fixture Patterns

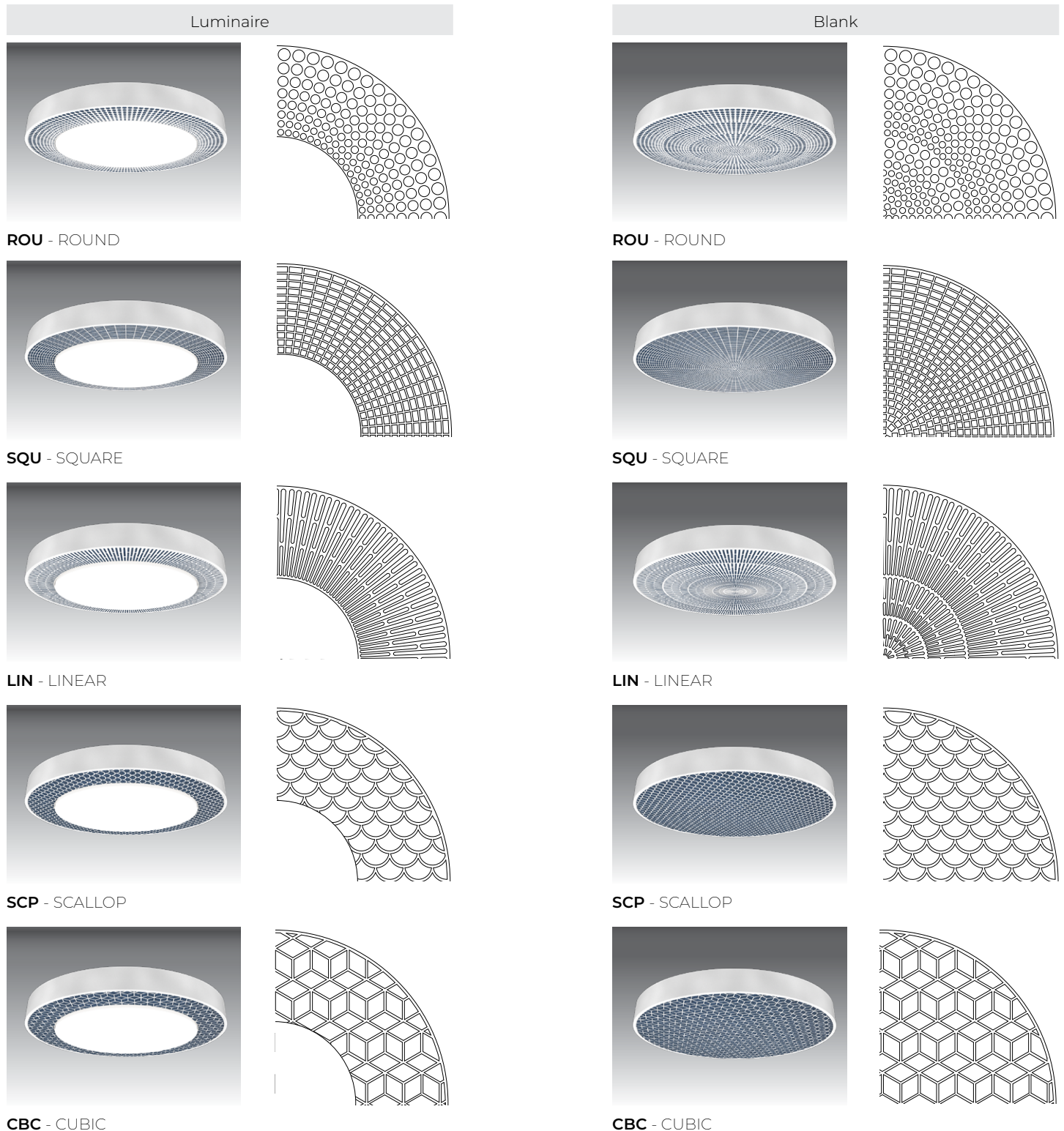

POP ECHOCORE ROUND



SURFACE
STATIC WHITE, FULL SPECTRUM

Dimensions

Lens position

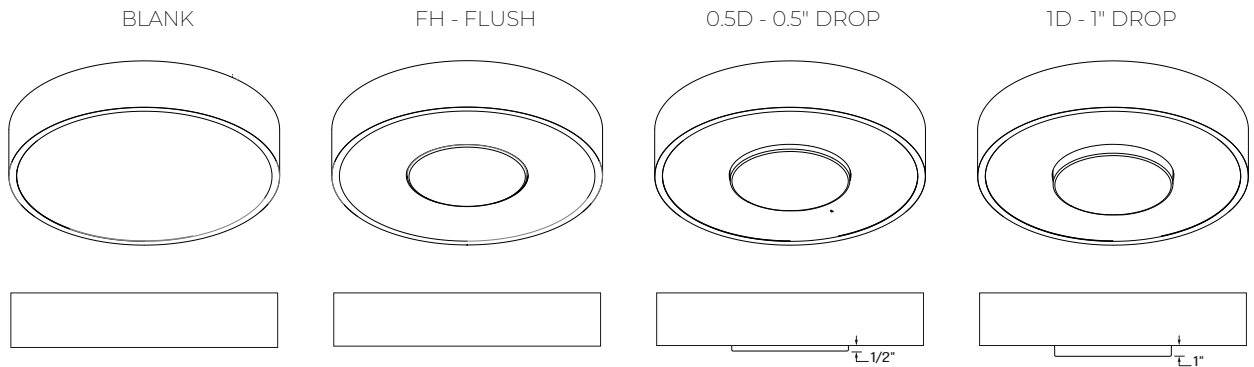

Section view

Fixture Dimensions

FIXTURE SIZE	A BODY DIAMETER	B LENS DIAMETER
Ø 24"	12 5/16"	10 3/4"
Ø 36"	36 5/16"	22 3/4"
Ø 48"	48 5/16"	34 3/4"

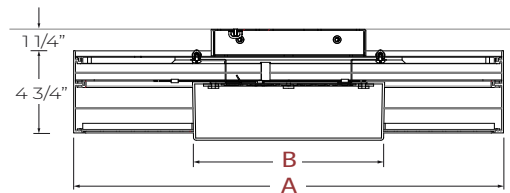

Photometrics

Delivered lumens at 35K at 80 CRI for all optics.

Ø 24"

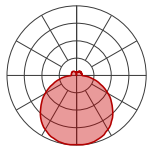

LUMEN OUTPUT	INPUT WATTS	LPW
750	7.5	98
900	9.5	96
1100	11.5	97

Ø 36"

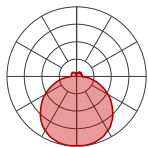

LUMEN OUTPUT	INPUT WATTS	LPW
2500	23.5	106
3500	34.5	102
4500	46	98

Ø 48"

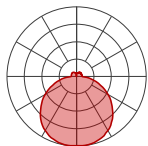

LUMEN OUTPUT	INPUT WATTS	LPW
4000	37	108
5500	52	106
8000	78.5	102

MULTIPLIER TABLES

Use these tables to get results for different color temperatures, CRI, and drop lenses, for all photometric tables.

Multiplier - CCT/CRI

CCT (K)	Watts		LPW	
	CRI 80	CRI 90	CRI 80	CRI 90
2700	1.05	1.26	0.95	0.79
3000	1.01	1.23	0.99	0.81
3500	1.00	1.20	1.00	0.84
4000	1.00	1.17	1.00	0.85

Multiplier - Drop Lens

DIRECT LENS	WATTS MULTIPLIER	LPW MULTIPLIER
Flush Lens	1.00	1.00
Drop Lens 0.5"	0.86	1.16
Drop Lens 1.5"	0.84	1.19

POP ECHOCORE ROUND



SURFACE
STATIC WHITE, FULL SPECTRUM

ACOUSTIC CALCULATOR

Using the Lumenwerx Acoustix Value Calculator table, you can determine the number of acoustic luminaires required in a space by fixture type. We have three levels of recommended sound reduction: good, better, and best. Choosing one of these options will reduce the sound accordingly. The best option indicates the best acoustic improvement. Calculations are based on a standard ceiling height of 9 feet.



- 1 Calculate the square feet of your room (L x W).
- 2 Choose the level of acoustical improvement you are looking for, and find the corresponding value based on your room dimension and luminaire configuration.

% in reduction in reverberation time	
😊 GOOD	25%
😊😊 BETTER	40%
😊😊😊 BEST	50%

SIZE	Room dimensions under 300 sq ft			Room dimensions over 300 sq ft		
	GOOD 😊	BETTER 😊😊	BEST 😊😊😊	GOOD 😊	BETTER 😊😊	BEST 😊😊😊
LUMINAIRE						
Ø 24"	19	11	8	29	16	13
Ø 36"	31	18	14	48	27	21
Ø 48"	44	25	19	68	38	30
BLANK						
Ø 24"	25	14	11	39	22	17
Ø 36"	58	32	25	89	50	39
Ø 48"	105	59	46	163	91	72

- 3 Use the Lumenwerx Acoustix Value Formula to determine the number of luminaires needed in the room.

$$\text{Square feet} \div \text{Value} = \text{Number of luminaires}$$

Example:

Luminaire: Pop Echocore Round Surface Ø 36"
Room square feet: L: 20 ft x W: 18 ft = 360 sq ft
Desired acoustical improvement: Better = 27
Number of luminaires needed in the room: $360 \div 27 = 14$ luminaires

NOTES:

- You can mix lit and blank fixtures.
- Lumenwerx acoustic calculators were developed to act as a guide. For precise acoustic performance in a space, please consult an acoustician.

POP ECHOCORE ROUND



SURFACE
STATIC WHITE, FULL SPECTRUM

Technical Specifications

OPTIC

Uniform Efficiency Lambertian Optic (ULO)

Made of formed impact modified white PMMA, the optic provides an even light distribution with up to 88% transmission. Its unique enclosed shell design protects LEDs against Electrostatic Discharge and dust while its back surface project a soft glow on the mounting surface.

LIGHT SOURCE

Custom array of mid-flux LEDs are mounted directly to the housing for optimal thermal performance. Available in 2700K, 3000K, 3500K and 4000K with a minimum 80 CRI and an option for 90 CRI and, 95 CRI with elevated R9 value. Color consistency maintained to within 3 SDCM. LEDs operated at reduced drive current to optimize efficacy and lumen maintenance. All LEDs have been tested in accordance with IESNA LM-80-08 and the results have shown L80 lumen maintenance greater than 60,000 hours. Absolute product photometry is measured and presented in accordance with IESNA LM-79, unless otherwise indicated. Optional full spectrum LEDs can be incorporated in the fixture to increase Cyanosis Observation Index (COI) and assist in regulating circadian rhythms.



WELL for Light - The WELL building standard focuses on light quality in several features. There are three categories that are fully attributed to the construction and features of a luminaire. In WELL V1, it's Feature 54 Circadian Lighting, Feature 55 Glare Control, and Feature 58 Color Quality. In WELL V2, it's Feature L03 Circadian Lighting, Feature L04 Glare Control, and Feature L07 Electric Light Quality.

This fixture meets Features:

- Feature 54 or L03 when full spectrum is selected
- Feature 55 or L04 meets WELL glare category (c-d)
- Feature 58 or L07 when 90 CRI or above is selected

All LED drivers used at Lumenwerx are deemed to have a low risk level of flicker, of 5 % or less below 90Hz operational as defined by IEEE standard 1789-2015 LED.



WELL for Sound - This luminaire is recommended for use as an acoustical absorption surface to limit reverberation times (RT) in a given space. This luminaire contributes to noise reduction and vibration dampening to promote focus and concentration. Reverberation needs to be calculated in each space based on the materials used.



WELL for Mind -This luminaire meets WELL for mind as it is a human centric luminaire offering quality light, excellent color, smooth optics, and a sound diminishing element. If any of these features are incorporated in a luminaire, it can improve the ability to focus, concentrate, and persist longer on a given task. This fixture harmoniously operates in a space to assist the mind.

For more information please contact well@lumenwerx.com.

ELECTRICAL

Factory-set, adjustable output current LED driver with universal (120-277 VAC) input. Dimmable from 100% to 1% with 0-10V dimming control. Rated life (90% survivorship) of 50,000 hours at 50°C max. ambient (and 70°C max. case) temperature. At maximum driver load: Efficiency>84%, PF>0.9, THD<20%. Other specifiable options include Lutron Hi-Lume 1% Eco, eldoLED 1% ECoDrive 0-10V, eldoLED 0.1% SOLOdrive 0-10V, ELV, TRIAC, and DALI protocol drivers. All of our standard 0-10V drivers are NEMA 410 compliant.

PoE

Depending on the PoE manufacturer selected, Lumenwerx will install the node in factory as either integral to the luminaire or as a remote module. Factory programming of the PoE node may or may not enable the following functionalities: lumen package, Duo (tunable white) emergency battery backup, and sensor integration. These must be addressed and evaluated on a case-by-case basis.

MOUNTING

Fixtures can be mounted directly to drywall and hard surface ceilings, hardware supplied by others.

FINISH

Interior - 95%, reflective, matte white powder coating

Exterior - Side trim is offered in a range of vibrant color powder coating.

ACOUSTIC FINISH

Material is 100% polyester containing up to 50% of recycled plastic bottles (PET) with an ASTM E-84 Class A fire rating and is moisture resistant.

CARE

Remove dust and debris with a clean, dry, soft, lint-free cloth, or vacuum.

POP ECHOCORE ROUND



SURFACE
STATIC WHITE, FULL SPECTRUM

CONSTRUCTION

Housing - Rolled and seamlessly welded aluminum extrusion 0.125" thick

Mounting housing - 16 gauge cold rolled steel, painted white

Interior brackets - Die formed cold rolled sheet steel 18 gauge thick

Reflectors - Cold rolled steel 0.0246" thick precisely die formed, 95% reflective matte white painted

Lens - Uniform Lambertian Optic, thermoformed impact-modified acrylic, completely enclosed

Perforated panel - Die cut aluminum panel (18 gauge aluminum sheet)

WEIGHT

Size	Direct	Blank
Ø 24"	33 lbs - 15 kg	28.66 lbs - 13 kg
Ø 36"	44 lbs - 20.4 kg	41.88 lbs - 19 kg
Ø 48"	72.75 lbs - 33 kg	68.34 lbs - 31 kg

ENVIRONMENT

Ambient temperature at fixture location shall be within 0°C/32°F - 25°C/77°F, indoor dry or damp as well as outdoor damp use (canopies or marquees).

CERTIFICATION

ETL - Rated for Indoor Dry/Damp locations. Conforms to UL Standard 1598 and certified to CAN/CSA Standard C22.2 No. 250.0.

WARRANTY

Lumenwerx provides a five-year limited warranty of electrical and mechanical performance of the luminaires, including the LED boards, drivers, and auxiliary electronics. Lumenwerx will repair or replace defective luminaires or components at our discretion, provided they have been installed and operated in accordance with our specifications. Other limitations apply, please refer to the full warranty on our website.