

POP COLOR ROUND 12



Lumenwerx

SURFACE
CHROMAWERX - SOLA AND DUO



Project: _____
Type: _____



See page 5 for more color options

DESCRIPTION

POP Color features a painted housing with a uniformly luminous diffuser that sits flush, regressed or drops up to 2" below. POP Color delivers up to 101 LPW and is available in nine standard housing colors. POP Color is an ideal vehicle for Chromawerx white tuning in education, office, and healthcare applications where modular luminaires are used.



Flush lens

2" regressed lens

1" drop lens

2" drop lens

Order Guide

Up to 101 lm/W performance

LUMINAIRE ID	SIZE	OPTIC	LENS POSITION	LIGHT SOURCE ¹	CRI	LUMEN PACKAGE
	12IN	ULO				
PCROS - Pop Color Round Surface PCRORGS - Pop Color Round Regressed Lens Surface	12IN - Ø12"	ULO - Uniform Lambertian Optic	PCROS FH - Flush 1D - 1" drop 2D - 2" drop PCRORGS 2R - 2" regressed	SOLA - Dim-to-warm single channel control 35K to 22K DUO - Tunable white 2-channel control 65K to 27K ¹ Static white also available. Consult other spec sheet.	80 - 80 CRI 90 - 90 CRI	750 - Min. low output 750lm 900 - Medium output 900lm 1100 - Max. high output 1100lm ##### - Other required lm

VOLTAGE	DRIVER ²	ELECTRICAL	MOUNTING	FINISH	OPTIONS
		1	SUR		
120 - 120V 277 - 277V UNV - 120V-277V	<u>SOLA</u> SD1 - Single 0-10V input <u>DUO</u> DMX ³ - DMX, to specify see pages 7 to 12 DA ³ - DALI DD1 - Dual 0-10V input for CCT/intensity LD2 ³ - Lutron DALI-2 digital ² PoE (Power-over-Ethernet) compatible. Consult factory for details. ³ On-site commissioning is required.	1 - 1 circuit	SUR - Surface mount	W - Matte white AL - Aluminum B - Matte black RAL 1028 - Yellow RAL 2004 - Orange RAL 3020 - Red RAL 4010 - Magenta RAL 5002 - Blue RAL 6018 - Green CF# - Custom finish specify RAL#	FU120 - Fuse 120V FU277 - Fuse 277V NA - None

Accessories

Optional, order separately

DMX WALL CONTROLLER ⁴

WCW - Wall controller white
WBW - Wall controller black

⁴Available with DMX only. For more information, see pages 7 to 12, or consult factory.

POP COLOR ROUND 12



SURFACE
CHROMAWERX - SOLA AND DUO

Dimensions

POP COLOR FH - FLUSH

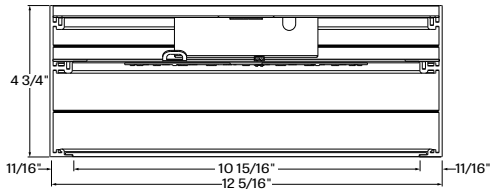
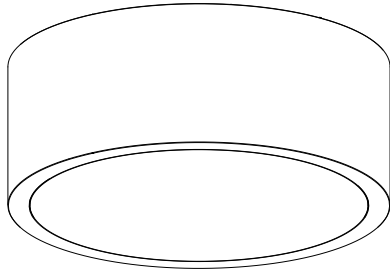

POP COLOR 2R - 2" REGRESSED

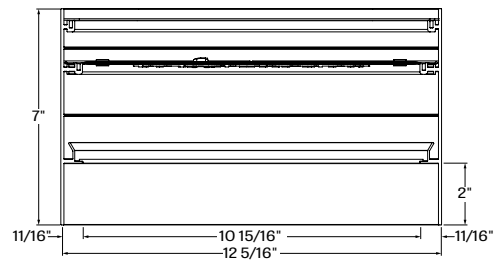
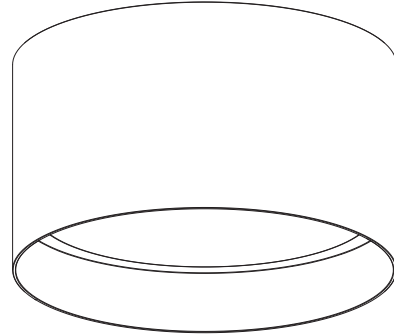

POP COLOR 1D - 1" DROP

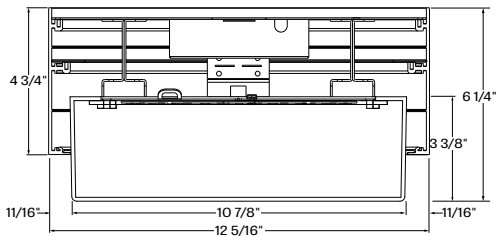
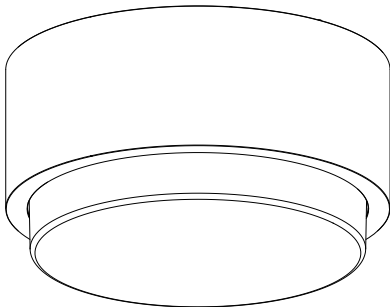

POP COLOR 2D - 2" DROP

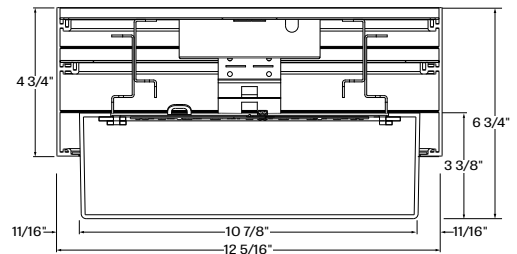
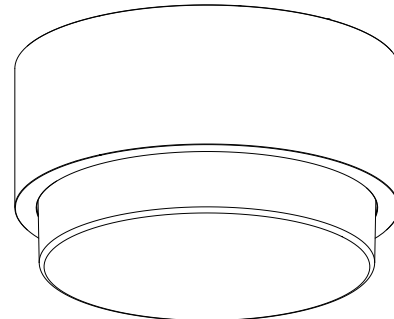

POP COLOR ROUND 12



SURFACE
CHROMAWERX - SOLA AND DUO

Photometrics

750 LUMEN AT 80 CRI - LOW OUTPUT

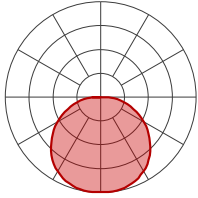

LED OUTPUT	COLOR TEMP	WATTS	NOMINAL DELIVERED LUMENS	EFFICACY LPW
Low output	2700K	8	750	93
Low output	3000K	8	750	95
Low output	3500K	7.5	750	98
Low output	4000K	7.5	750	101
Low output	5000K	7	750	105
Low output	6500K	7	750	105

900 LUMEN AT 80 CRI - MEDIUM OUTPUT

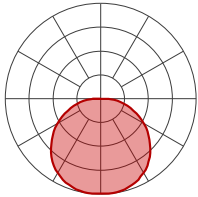

LED OUTPUT	COLOR TEMP	WATTS	NOMINAL DELIVERED LUMENS	EFFICACY LPW
Medium output	2700K	10	900	91
Medium output	3000K	9.5	900	93
Medium output	3500K	9.5	900	96
Medium output	4000K	9	900	99
Medium output	5000K	8.5	900	103
Medium output	6500K	8.5	900	103

1100 LUMEN AT 80 CRI - HIGH OUTPUT

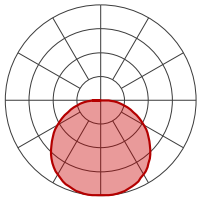

LED OUTPUT	COLOR TEMP	WATTS	NOMINAL DELIVERED LUMENS	EFFICACY LPW
High output	2700K	11.5	1100	95
High output	3000K	11.5	1100	94
High output	3500K	11.5	1100	97
High output	4000K	11	1100	100
High output	5000K	10.5	1100	104
High output	6500K	10	1100	108

SURFACE CHROMAWERX - SOLA AND DUO

Technical Specifications

OPTIC

Uniform Efficiency Lambertian Optic (ULO)

Made of formed impact modified white PMMA, the optic provides an even light distribution with up to 88% transmission. Its unique enclosed shell design protects LEDs against Electrostatic Discharge and dust while its back surface project a soft glow on the mounting surface.

LENS POSITION

Pop round 12 surface is available in 4 lens configurations.

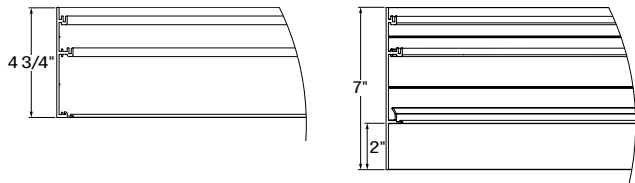

PCROS + FH - Flush lens

PCRORGS + 2R - 2" regressed lens

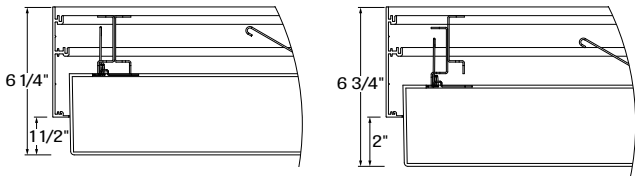

PCROS + 1D - 1" drop lens

PCROS + 2D - 2" drop lens

LIGHT SOURCE

Custom array of alternating color temperature mid-flux LED's are mounted directly to the housing for optimal thermal performance. For the Duo products, a color temperature range from 6500K-2700K is achievable with color points on or below the black body curve. For the Sola products, a color temperature range from 3500K-2200K is controlled synchronously with intensity. Color consistency between fixtures is maintained to within 3SDCM. LEDs are operated at reduced drive current to optimize efficacy and lumen maintenance.

All LED's have been tested in accordance with IESNA LM-80-08 and the results have shown L80 lumen maintenance greater than 60,000 hours. Absolute product photometry is measured and presented in accordance with IESNA LM-79, unless otherwise indicated.

CHROMAWERX - TUNABLE WHITE

Chromawerx Sola

It is a single-channel control that dims output while warming the color temperature in a pre-determined relationship. A simple analog control sends a common signal to dual output digital drivers, which are programmed to adjust a specially populated LED array to emulate the effect of dimming a filament source. Dimming range is programmable but the default option runs from 3500K at 100% of full power to 2200K at 5% of full power. CRI is maintained above 80 throughout the dimming range.

Chromawerx Duo

It is a two-channel control. It uses an analog (0-10V) protocol for separate control of luminaire CCT and intensity or a digital (DMX, DALI and LD2) protocol for synchronous control of both warm and cool LED arrays to enable the user to set color temperature and light output. Commonly called "tunable white", Chromawerx two-channel control provides the range of cool (6500K) to warm (2700K) color that can be useful for helping to entrain circadian rhythms, stimulate alertness for improved educational and work productivity, and compensate for jet lag, among other applications. The Chromawerx drivers are programmed to limit maximum light output and power usage across all color temperatures. CRI is maintained above 80.

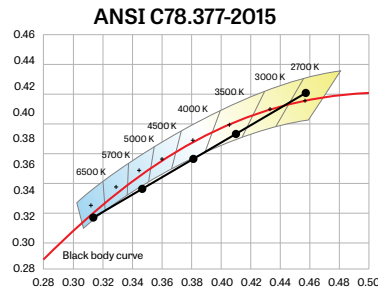

POP COLOR ROUND 12



Lumenwerx

SURFACE

CHROMAWERX - SOLA AND DUO

ELECTRICAL

SOLA

SDI

Factory-set, adjustable output current LED driver with universal (120-277VAC) input. Using a single 0-10V control signal, the light output warms in color temperature as it dims down to 1% and 2200K. At maximum driver load, efficiency<86%, PF>0.9, THD<20%.

DUO

DMX

Factory-set adjustable output current electronic driver with 120-277V AC line input. Using DMX wall controls (optionally supplied by Lumenwerx) or an existing DMX control system, both channels of LEDs are independently adjustable. Each DMX driver can be independently addressed using the built-in RDM (Remote Device Management) in the field. Dimming down to 1% is attainable. Rated life (90% survivorship) of 50,000 hours at 50°C maximum ambient temperature. At maximum driver load, efficiency<84%, PF>0.9, THD<20%.

DALI

Factory-set adjustable output current electronic driver with 120-277V AC line input. Using an existing DALI control system (supplied by others), one control channel adjusts the fixture color temperature, and the other control channel adjusts fixture brightness. Dimming down to 1% is attainable. Rated life (90% survivorship) of 50,000 hours at 50°C maximum ambient temperature. At maximum driver load, efficiency<84%, PF>0.9, THD<20%.

DDI

Factory-set adjustable output current LED driver with universal (120-277VAC) input. Controlled via two individual 0-10V signals, one for setting light output down to a minimum of 1% and the other for adjusting the CCT (default range of 6500K-2700K). Rated life of 50,000 hours at 70°C maximum driver case temperature and 100% load conditions. Typical efficiency of 86%, PF>0.9, THD<20% at 100% load conditions.

LD2

Lutron DALI-2 digital drivers provide a high-performance tunable white solution with single-address digital control. Guaranteed performance and compatibility when used with Lutron DALI-2 controls.

PoE

Depending on the PoE manufacturer selected, Lumenwerx will install the node in factory as either integral to the luminaire, or as a remote module. Factory programming of the PoE node may or may not enable the following functionalities: lumen package, Duo (tunable white), emergency battery backup, and sensor integration. These must be addressed and evaluated on a case-by-case basis.

MOUNTING OPTION

Fixtures can be mounted directly to T-bar, drywall and hard surface ceilings. Mounting hardware supplied by others.

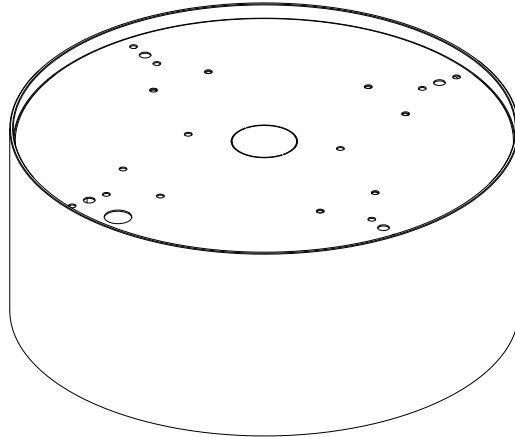

SUR - Surface mount

FINISH

Interior - 95%, reflective, matte white powder coating

Exterior - Side trim is offered in a range of vibrant color powder coating.



W - Matte white

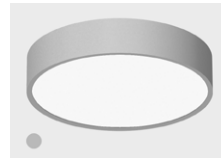

AL - Aluminum

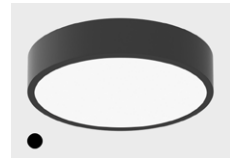

B - Matte black



RAL 1028 - Yellow



RAL 2004 - Orange



RAL 3020 - Red



RAL 4010 - Magenta



RAL 5002 - Blue



RAL 6018 - Green

POP COLOR ROUND 12



Lumenwerx

SURFACE

CHROMAWERX - SOLA AND DUO

CONSTRUCTION

Housing - Rolled and seamlessly welded aluminum extrusion
.125in thick, wide variety of colored powder coating

WEIGHT

RD 12 Flush, 2R, 1D, 2D - 6.15lb - 2.8kg

CERTIFICATION

ETL - Rated for Indoor Dry/Damp locations. Conforms to UL Standard 1598 and certified to CAN/CSA Standard C22.2 No. 250.0.

WARRANTY

Lumenwerx provides a five-year limited warranty of electrical and mechanical performance of the luminaires, including the LED boards, drivers, and auxiliary electronics. Lumenwerx will repair or replace defective luminaires or components at our discretion, provided they have been installed and operated in accordance with our specifications. Other limitations apply, please refer to the full warranty on our website.

Wall controllers are covered by the manufacturer warranty.



SURFACE

CHROMAWERX - SOLA AND DUO

DUO DMX SPECIFICATION

A qualified DMX integrator is required to assure proper installation and commissioning of the DMX network. **When placing the PO, please provide the contact information of your DMX integrator.**

Please answer the following questions to help us identify your DMX network requirements.

YES

Do you require a wall controller provided by Lumenwerx?

NO

DMX control system supplied by others. Lumenwerx will supply DMX-enabled fixtures with default DMX addressing. See following pages for technical DMX informations.

DMX controller supplied by Lumenwerx

How many zones do you have?

A zone consists of one or more luminaires behaving identically.



1 Zone



2 Zones

How to calculate the required number of drivers:

per 4' fixture

Driver

1x driver

Direct only

per 4' fixture

Driver

Driver

2x driver

Direct high output

To Calculate # of drivers

NO

YES

1 - 4 Zones

5 or more Zones

Do you have more than 32 drivers in total?

Order a standard Lumenwerx wall controller.

WALL CONTROLLER

WCW - wall controller white

WCB - wall controller black

Add the control code at the end of your order code.

Please provide a fixture layout or RCP (Reflected Ceiling Plan) showing the locations of the DMX fixtures, zones and the DMX wall controller.

Refer to your DMX integrator for the installation.

Subject to factory evaluation. Please contact our controls specialist at controls@lumenwerx.com. Additional cost and equipment will be required.

Subject to factory evaluation and approval. Please contact our controls specialist at controls@lumenwerx.com. Additional cost and equipment will be required.



SURFACE

CHROMAWERX - SOLA AND DUO

GENERIC DMX NETWORK ARCHITECTURE

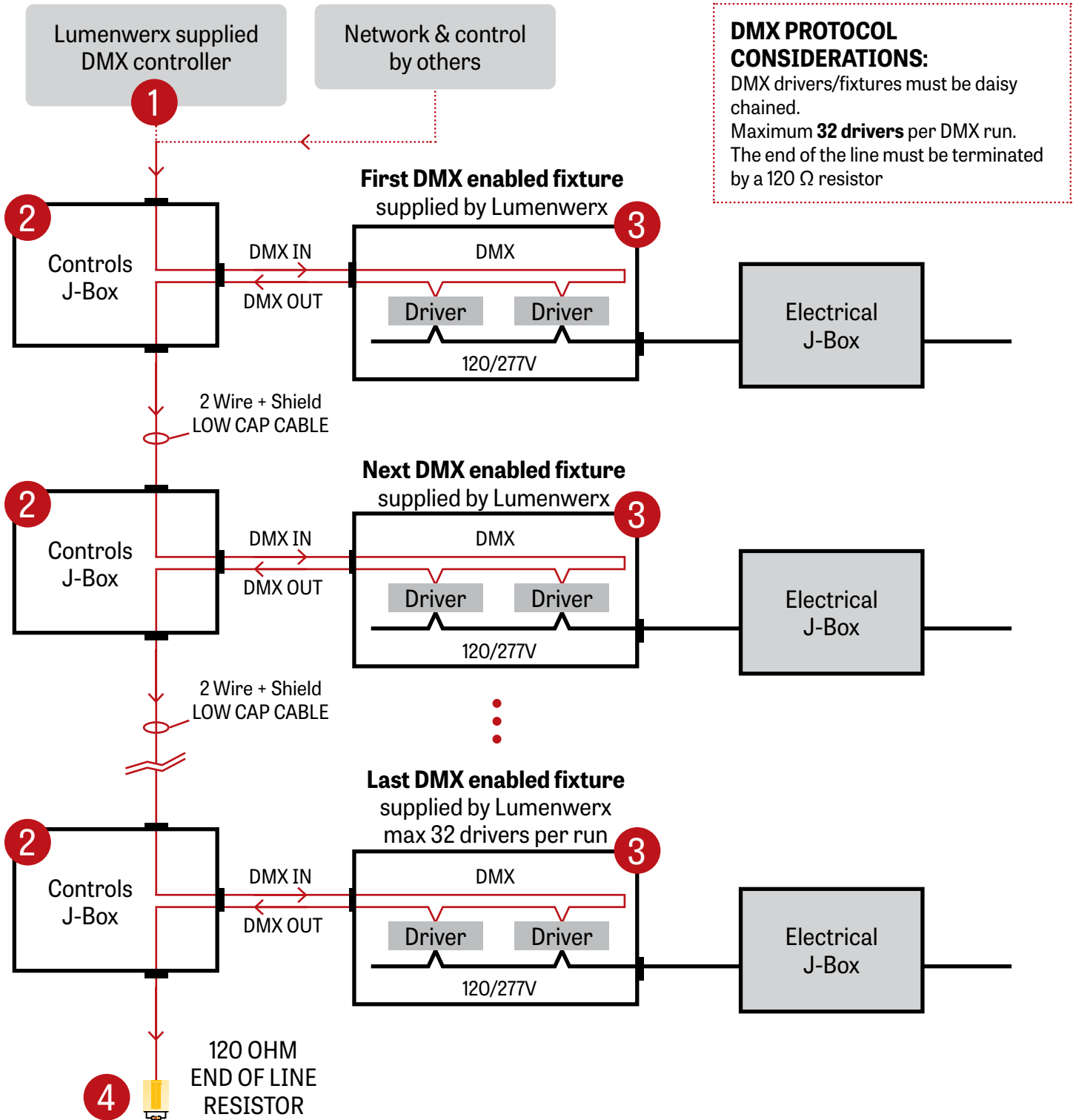

POP COLOR ROUND 12



Lumenwerx

SURFACE

CHROMAWERX - SOLA AND DUO

1 LUMENWERX SUPPLIED DMX CONTROLLER

To the first fixture

WALL BOX SUPPLIED BY OTHERS

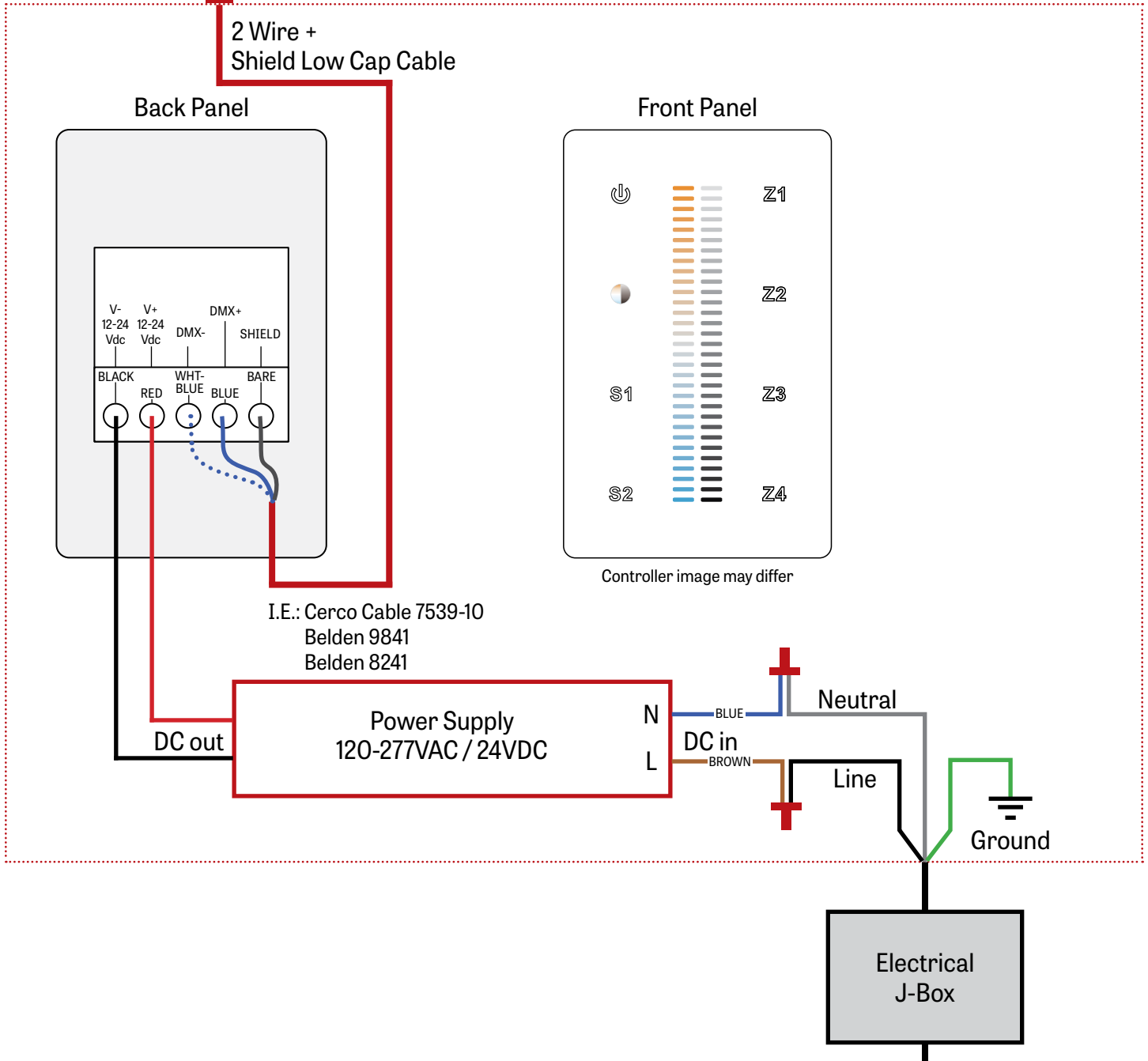



SURFACE

CHROMAWERX - SOLA AND DUO

2 J-BOX DMX DAISY CHAIN DETAIL

Low capacitance DMX Cable from Previous Fixture

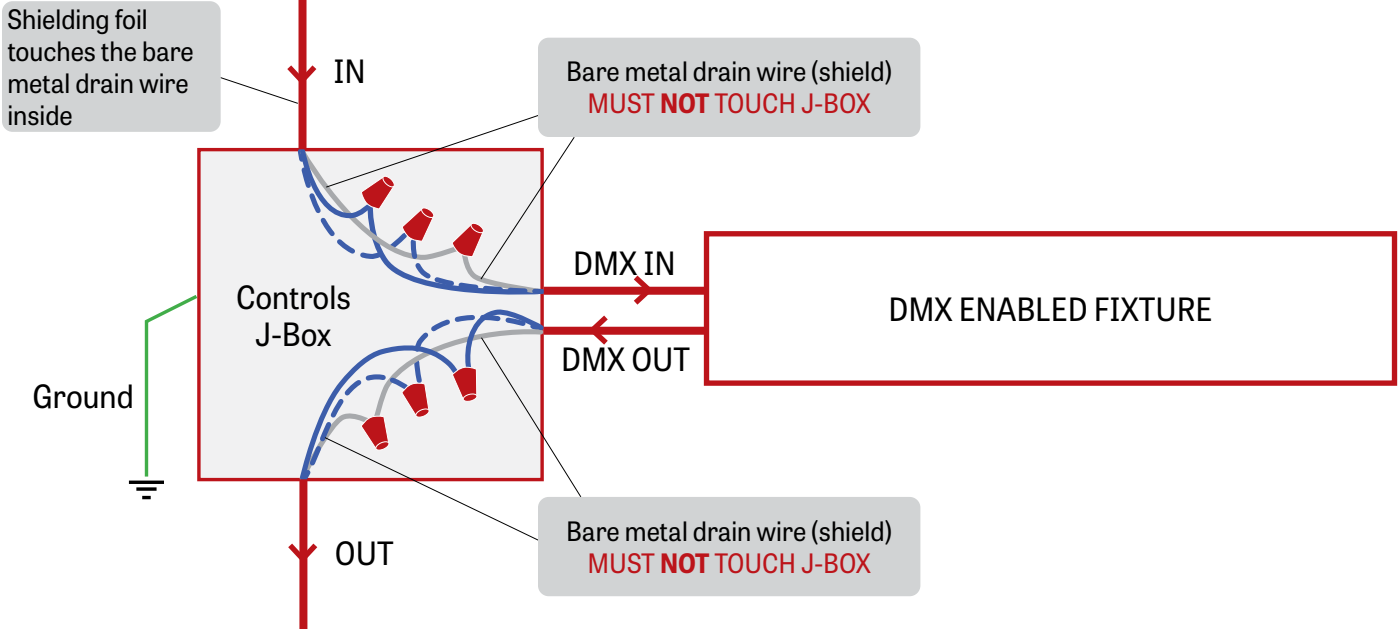

Low capacitance DMX cable to next fixture

3 DMX CONNECTION RECESSED & SURFACE

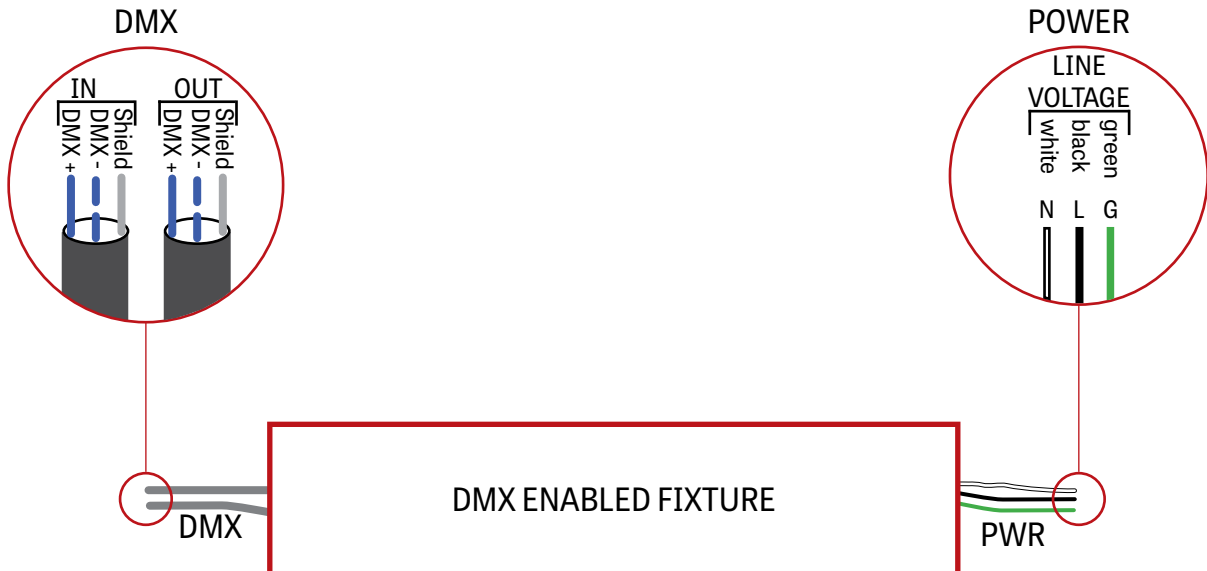

POP COLOR ROUND 12



Lumenwerx

SURFACE

CHROMAWERX - SOLA AND DUO

4 DMX LAST FIXTURE DETAIL

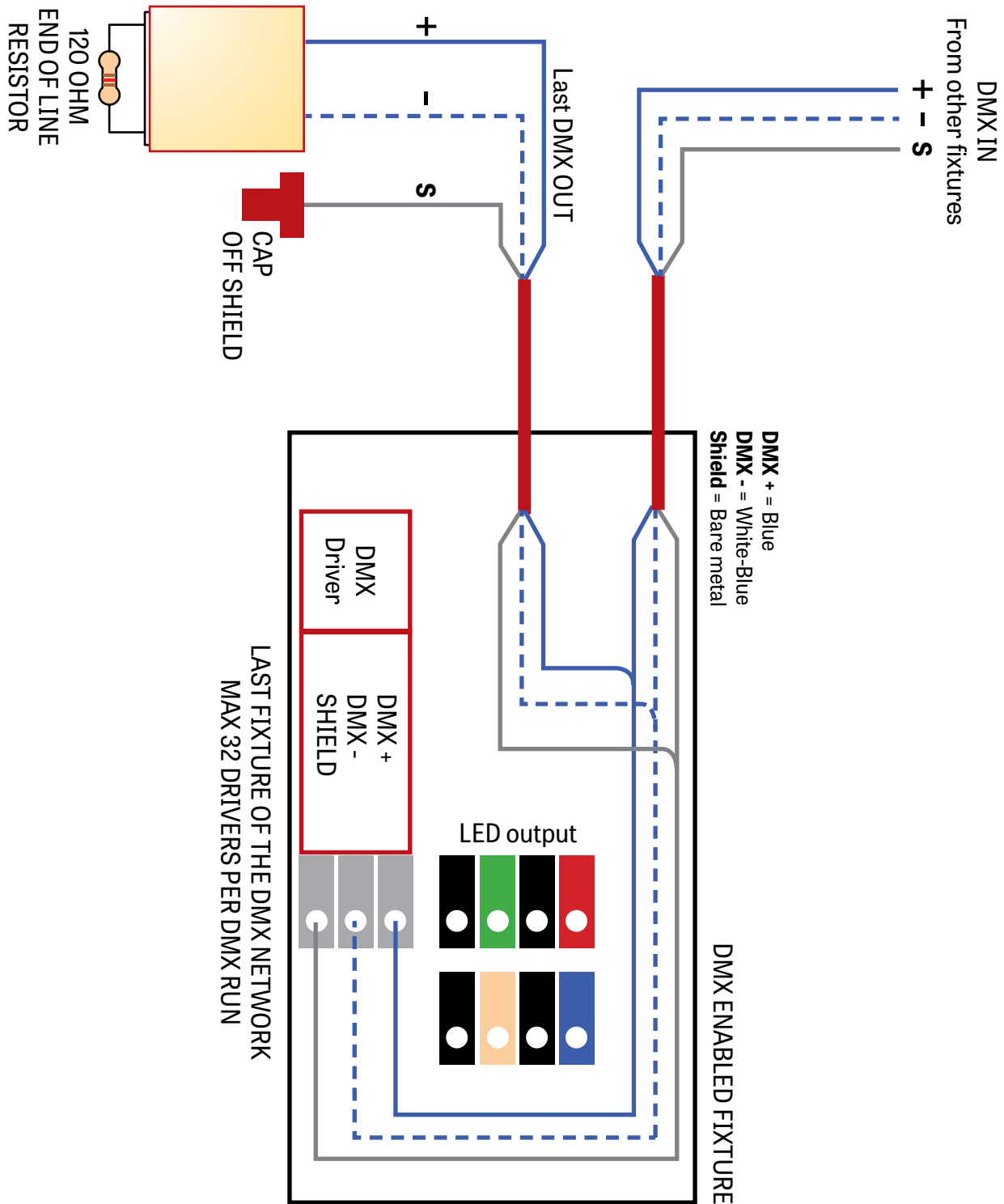

POP COLOR ROUND 12



SURFACE

CHROMAWERX - SOLA AND DUO

DMX WALL CONTROLLER

DUO 1-4 ZONE

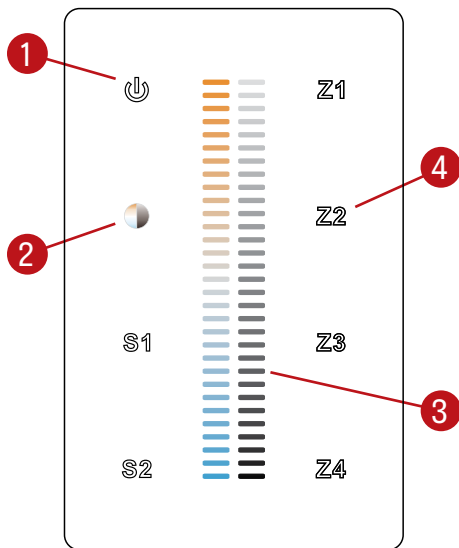

- (1) Power: Use this button to turn ON or OFF the fixture.
- (2) Brightness/CCT: Use the color/brightness toggle button to choose between color/brightness. When Blue: brightness is selected, when Yellow: color is selected.
- (3) Slider: Depending on the mode chosen in step 2, the slider will allow the user to set desired color or brightness.
- (4) Zone select: Up to 4 zones can be selected either independently or together. Once selected, the commands will be sent to the zone identified by a Blue LED.

Default DMX Addresses:

- 1 Warm
- 2 Cool