

POP CORE SQUARE 1x1 LED



LUMENWERX
WWW.LUMENWERX.COM

SURFACE-WALL - CHROMAWERX TUNABLE WHITE AND DIM TO WARM

IMPORTANT: a qualified DMX integration consultant is required to ensure proper installation and function of any DMX network

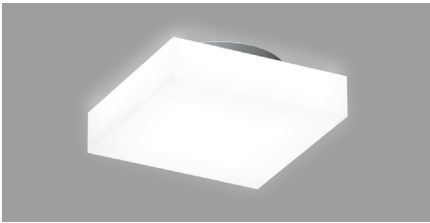

Surface with 2.5" optics

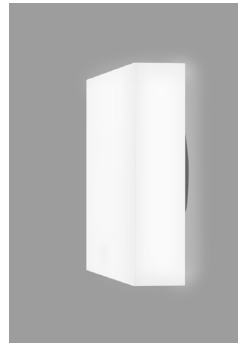

Wall with 2.5" optics

PROJECT: _____
 TYPE: _____
 NOTES: _____

DESCRIPTION

POP Core features a simple, uniformly luminous diffuser and delivers up to 106 LPW. The diffuser and light engine form a fully enclosed unit secured by a twist-and-lock mechanism for easy maintenance with no exposed hardware. POP Core is an ideal vehicle for ChromaWerx white tuning in education, office, and healthcare applications where modular luminaires are used. POP Core 2H, meets ADA requirements for wall mounting.



ORDER GUIDE

up to 106 lm/w performance

POSQS	1FTX1FT	ULO	2H	LED		
LUMINAIRE ID	SIZE	OPTICS	HEIGHT	LIGHT SOURCE	CRI	LUMEN PACKAGES
POSQS - pop square surface-wall	1FTX1FT - 1' X 1'	ULO - Uniform Lambertian Optic	2H - 2.5" optic	LED - high performance LED	80 - 80CRI 90 - 90CRI	750 - min. low output 750lm 900 - medium output 900lm 1100 - max. high output 1100lm #### - other required lm

CHROMAWERX	VOLTAGE	DRIVER	ELECTRICAL	MOUNTING	FINISH
DUO - tunable white 2 channel control 27k to 65k SOLA - dim to warm single channel control 22k to 35k	120 - 120V 277 - 277V	DMX - to specify see pages 4 to 9 DA - Dali (duo only) local on-site commissioning is required O-10 - Single 0-10V input (Sola) or dual 0-10V input for CCT/Intensity (Duo) PSQO - Lutron T-Series 1% Tunable White (Duo only)	1 - 1 circuit	SUR - surface mount	W - matte white CF# - custom finish specify RAL#

OPTIONS
FU120 - Fuse 120V
FU277 - Fuse 277V
CU - custom

DMX WALL CONTROLS
To specify see pages 4 to 9

See page 2 for ordering code detailed information



CROSS SECTION

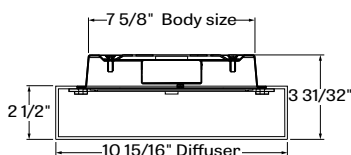

POSQS + 2H - pop square surface-wall with 2.5" optics

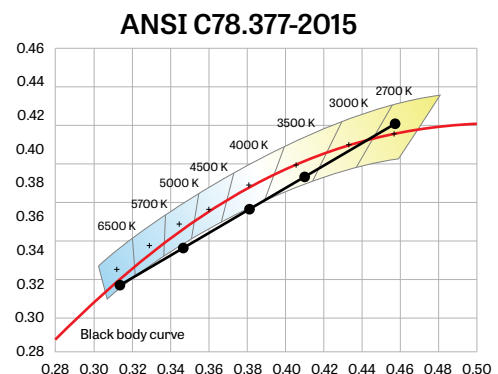

POP CORE SQUARE 1x1 LED

SURFACE-WALL - CHROMAWERX TUNABLE WHITE AND DIM TO WARM

OPTICS

UNIFORM EFFICIENCY LAMBERTIAN OPTIC (ULO) - made of formed impact modified white PMMA, the optic provides an even light distribution with up to 88% transmission. Its unique enclosed shell design protects LEDs against Electrostatic Discharge and dust while its back surface project a soft glow on the mounting surface.

OPTICS HEIGHT

POP square surface-wall 11 is available with 2.5" diffuser..

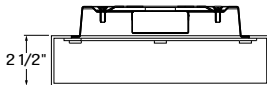

POSQS + 2H - pop square surface-wall with 2.5" optics

LIGHT SOURCE - LED

Custom array of alternating color temperature mid-flux LED's are mounted directly to the housing for optimal thermal performance. For the Duo products, a color temperature range from 2700K-6500K is achievable with color points on or below the black body curve. For the Sola products, a color temperature range from 2200K-3500K is controlled synchronously with intensity. Color consistency between fixtures is maintained to within 3SDCM. LEDs are operated at reduced drive current to optimize efficacy and lumen maintenance. All LED's have been tested in accordance with IESNA LM-80-08 and the results have shown L80 lumen maintenance greater than 60,000 hours. Absolute product photometry is measured and presented in accordance with IESNA LM-79, unless otherwise indicated.

PERFORMANCE AT 4000K

LED output	Color Temp	Watts	Nominal Delivered Lumens	Efficacy LPW
Low output	4000K	7.5	750	103
Medium output	4000K	8.5	900	105
High output	4000K	10.5	1100	106

Lumen Adjustment Factors

2700K	0.917
3000K	0.959
3500K	0.988
4000K	1.000
6500K	1.053

CHROMAWERX - TUNABLE WHITE

ANSI C78.377-2015

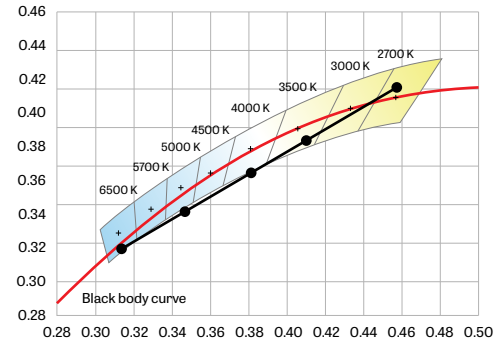

ChromaWerx Sola is single-channel control that dims output while warming the color temperature in a pre-determined relationship. A simple digital or analog control sends a common signal to dual output digital drivers, which are programmed to adjust a specially populated LED array to emulate the effect of dimming a filament source. Dimming range is programmable but the default option runs from 3500K at 100% of full power to 2200K at 5% of full power. CRI is maintained above 80 throughout the dimming range.

ChromaWerx Duo is a two-channel control. It uses analog or digital protocols for synchronous control of both warm and cool LED arrays, enabling the user to set color temperature and light output. Commonly called "tunable white", ChromaWerx two-channel control provides the range of warm (2700K) to cool (6500K) color that can be useful for helping to entrain circadian rhythms, stimulate alertness for improved educational and work productivity, and compensate for jet lag, among other applications. The ChromaWerx drivers are programmed to limit maximum light output and power usage across all color temperatures.

POP CORE SQUARE 1x1 LED

SURFACE-WALL - CHROMAWERX TUNABLE WHITE AND DIM TO WARM

ELECTRICAL

DMX (Duo only)

Factory-Set adjustable output current electronic driver with 120-277V AC line input. Using DMX wall controls (optionally supplied by Lumenwerx) or an existing DMX control system, both channels of LEDs are independently adjustable. Each DMX driver can be independently addressed using the built-in RDM (Remote Device Management) in the field. Dimming down to 1% is attainable. Rated life (90% survivorship) of 50,000 hours at 50°C maximum ambient temperature. At maximum driver load, efficiency<84%, PF>0.9, THD<20%.

Dali (Duo Only)

Factory-Set adjustable output current electronic driver with 120-277V AC line input. Using an existing DALI control system (supplied by others), one control channel adjusts the fixture color temperature, and the other control channel adjusts fixture brightness. Dimming down to 1% is attainable. Rated life (90% survivorship) of 50,000 hours at 50°C maximum ambient temperature. At maximum driver load, efficiency<84%, PF>0.9, THD<20%.

0-10V (Sola)

Factory-set, adjustable output current LED driver with universal (120-277VAC) input. Using a single 0-10V control signal, the light output warms in color temperature as it dims down to 1% and 2200K. At maximum driver load, efficiency<86%, PF>0.9, THD<20%.

0-10V (Duo)

Factory-set adjustable output current LED driver with universal (120-277VAC) input. Controlled via two individual 0-10V signals, one for setting light output down to a minimum of 1% and the other for adjusting the CCT (default range of 2700K-6500K). Rated life of 50,000 hours at 70°C maximum driver case temperature and 100% load conditions. Typical efficiency of 86%, PF>0.9, THD<20% at 100% load conditions.

PSQ0 (Duo only)

Lutron T-Series 2-Channel tunable white drivers enable high-performance human centric lighting (HCL) applications. Digital control of color temperature (CCT) and intensity are achieved when used with the ESN T-Series tunable white controller as a part of a Lutron Quantum System.

MOUNTING OPTIONS

A Twist and lock mounting system for clean look with no visible fastener and easy maintenance.

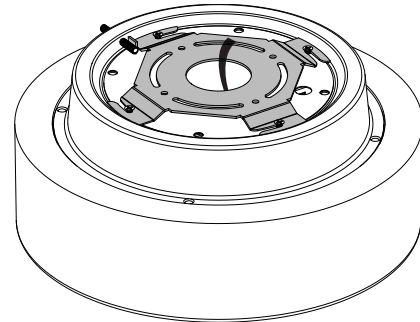

SUR - surface mount

FINISH

Interior - 95% reflective, matte white powder coating

Exterior - matte white powder coating.

CONSTRUCTION

Housing - 16 gauge spun aluminum, matte white powder coating

Diffuser - Uniform lambertian optic, precisely formed impact modified acrylic, completely enclosed

WEIGHT

SQ 11 X 2.5 - 23.41lbs - 1.55kg

CERTIFICATIONS

ETL - Rated for Indoor Dry/Damp locations.

Conforms to UL Standard 1598 and certified to CAN/CSA Standard C22.2 No. 250.0.

WARRANTY

For all ChromaWerx products, LumenWerx provides a three-year limited warranty of electrical and mechanical performance of the luminaires, including the LED boards, drivers, and auxiliary electronics. LumenWerx will repair or replace defective luminaires or components at our discretion, provided they have been installed and operated in accordance with our specifications. Other limitations apply, please refer to the full warranty on our website.

Wall controllers are covered by the manufacturer warranty.

POP CORE SQUARE 1x1 LED

SURFACE-WALL - CHROMAWERX TUNABLE WHITE

DUO DMX SPECIFICATION

A qualified DMX integrator is required to assure proper installation and commissioning of the DMX network. **When placing the PO, please provide the contact information of your DMX integrator.**

Please answer the following questions to help us identify your DMX network requirements.

YES

Do you require a wall controller provided by Lumenwerx?

NO

DMX control system supplied by others. Lumenwerx will supply DMX-enabled fixtures with default DMX addressing. See following pages for technical DMX informations. ✓

DMX controller supplied by Lumenwerx

How many zones do you have?

A zone consists of one or more luminaires behaving identically.

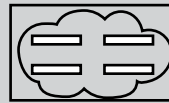

1 Zone



2 Zones

How to calculate the required number of drivers:

per 4' fixture

Driver

1x driver

Direct only

per 4' fixture

Driver

Driver

2x driver

Direct high output

To Calculate # of drivers

NO

YES

1 - 4 Zones

5 or more Zones

Do you have more than 32 drivers in total?

Order a standard Lumenwerx wall controller.

WALL CONTROLLER

WCW - wall controller white

WCB - wall controller black

Add the control code at the end of your order code.

Please provide a fixture layout or RCP (Reflected Ceiling Plan) showing the locations of the DMX fixtures, zones and the DMX wall controller.

Refer to your DMX integrator for the installation. ✓

Subject to factory evaluation. Please contact our controls specialist at controls@lumenwerx.com. Additional cost and equipment will be required. ✓

Subject to factory evaluation and approval. Please contact our controls specialist at controls@lumenwerx.com. Additional cost and equipment will be required. ✓

POP CORE SQUARE 1x1 LED

SURFACE-WALL - CHROMAWERX TUNABLE WHITE

GENERIC DMX NETWORK ARCHITECTURE

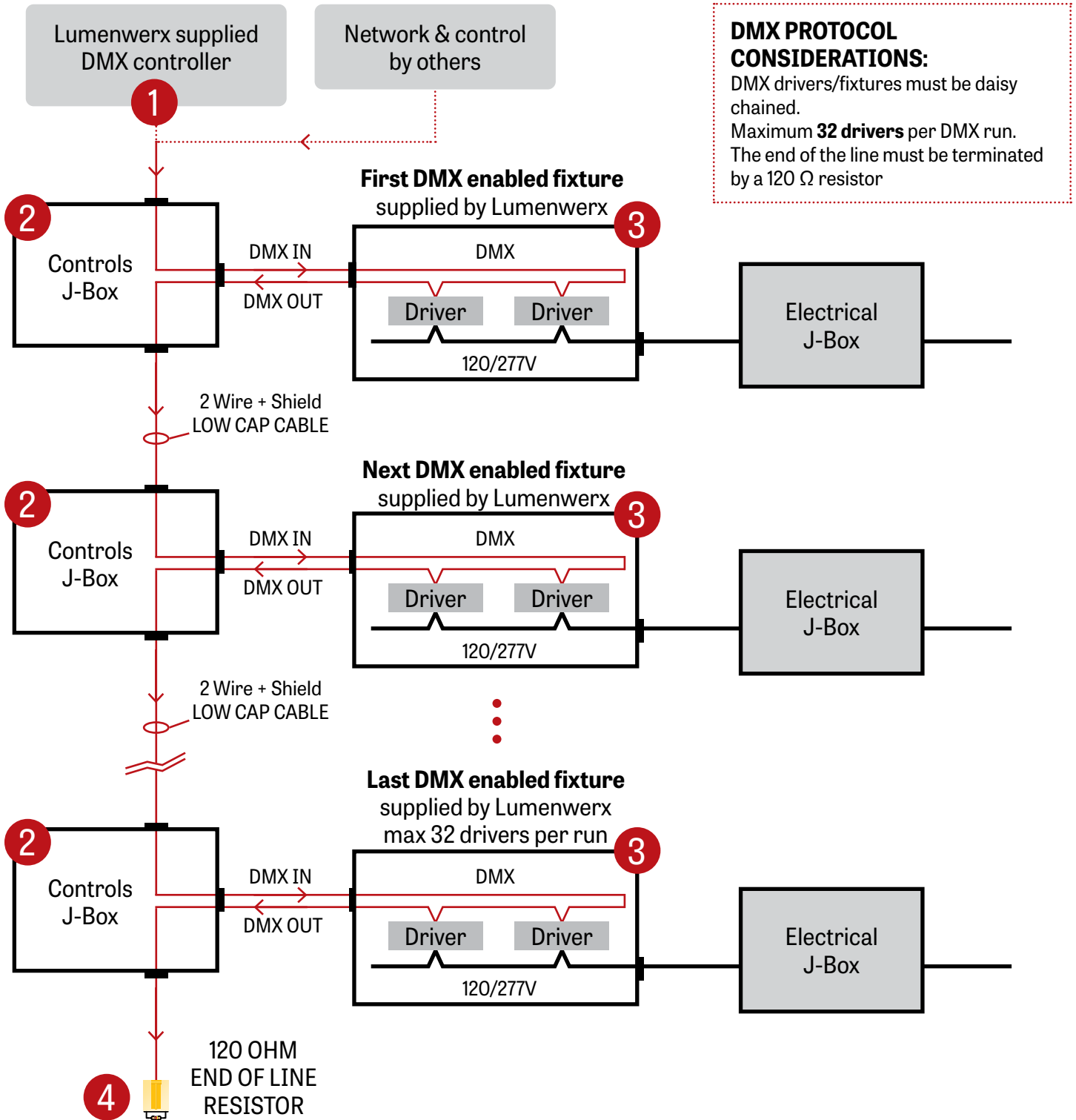

POP CORE SQUARE 1x1 LED

SURFACE-WALL - CHROMAWERX TUNABLE WHITE

1 LUMENWERX SUPPLIED DMX CONTROLLER

To the first fixture

WALL BOX SUPPLIED BY OTHERS

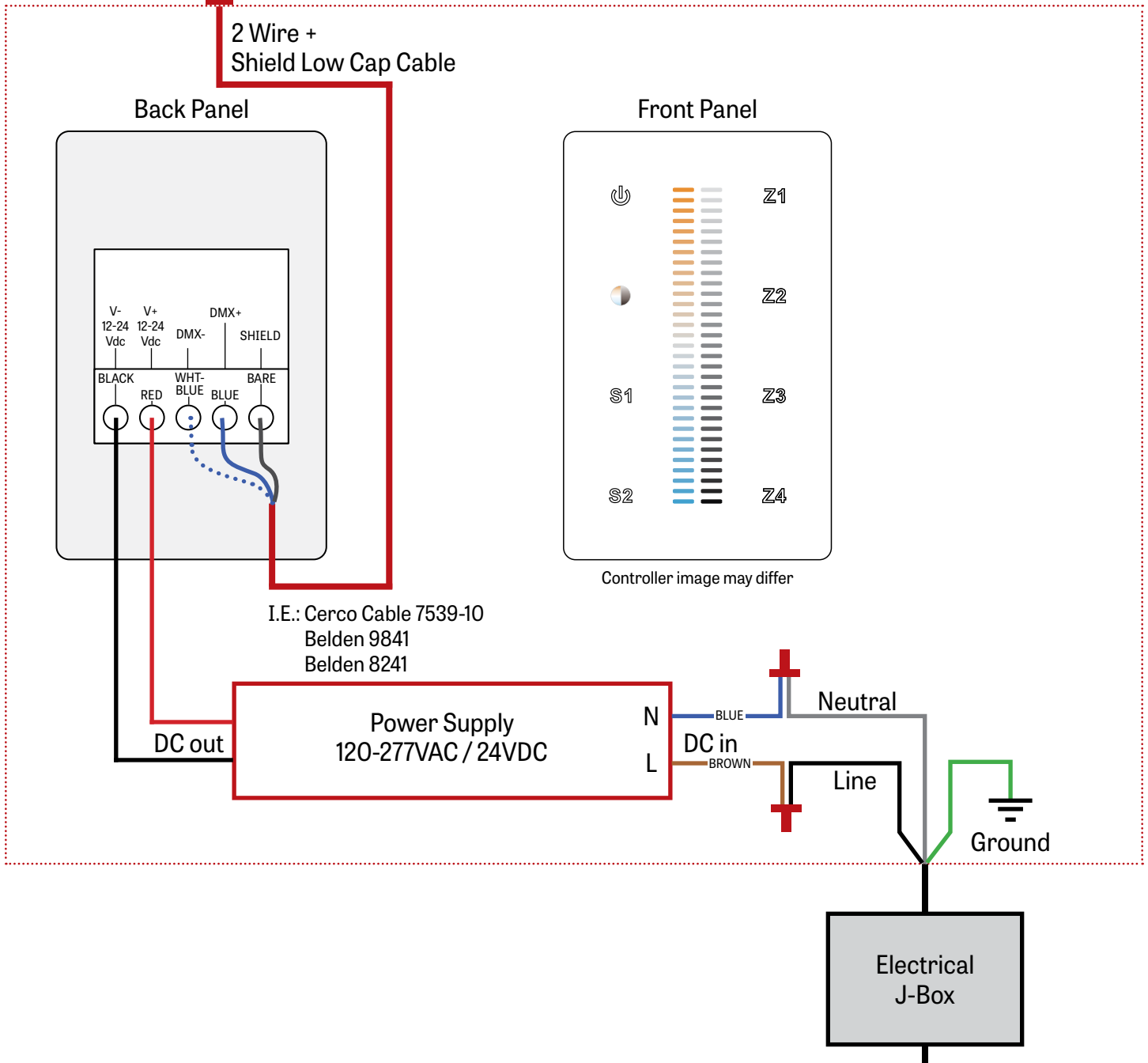

POP CORE SQUARE 1x1 LED

SURFACE-WALL - CHROMAWERX TUNABLE WHITE

2 J-BOX DMX DAISY CHAIN DETAIL

Low capacitance DMX Cable from Previous Fixture

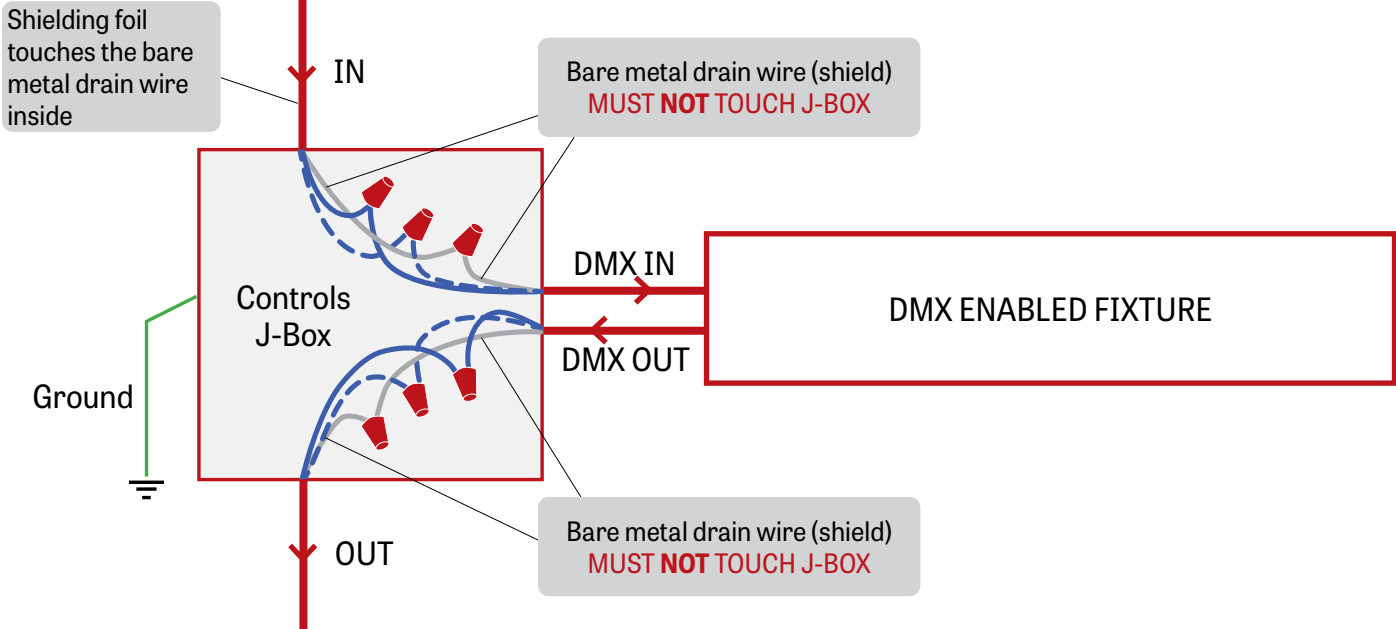

Low capacitance DMX cable to next fixture

3 DMX CONNECTION RECESSED & SURFACE

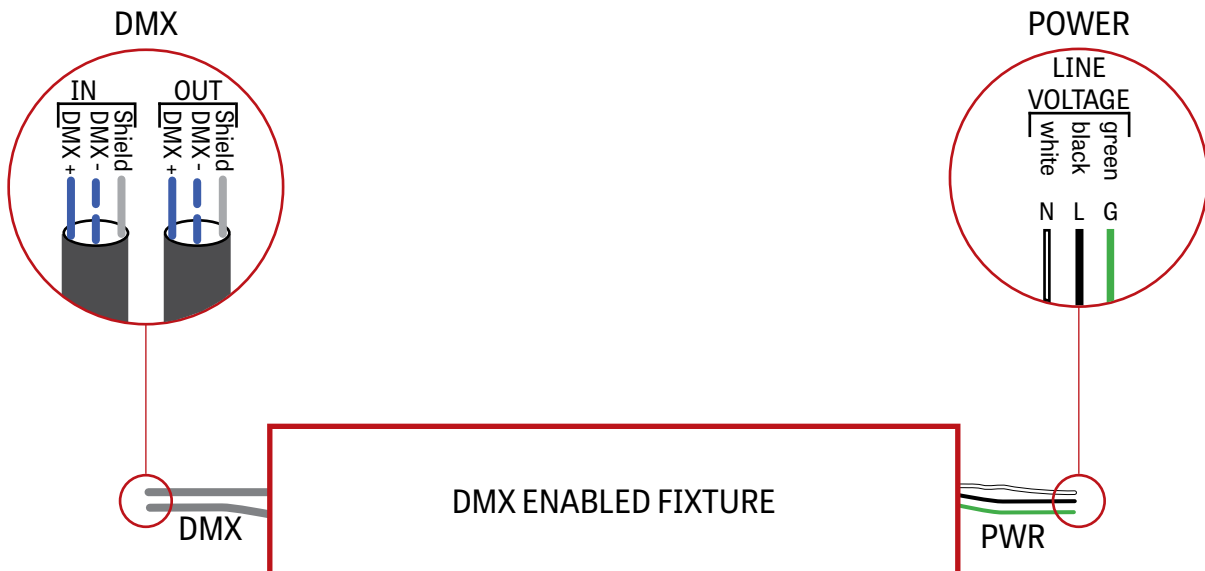

POP CORE SQUARE 1x1 LED

SURFACE-WALL - CHROMAWERX TUNABLE WHITE

DMX WALL CONTROLLER

DUO 1-4 ZONE

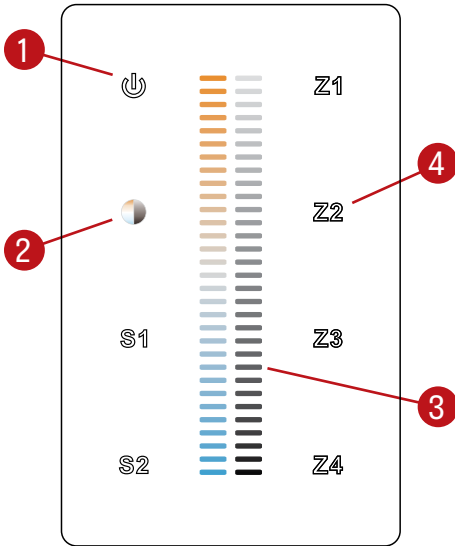

- (1) Power: Use this button to turn ON or OFF the fixture.
- (2) Brightness/CCT: Use the color/brightness toggle button to choose between color/brightness. When Blue: brightness is selected, when Yellow: color is selected.
- (3) Slider: Depending on the mode chosen in step 2, the slider will allow the user to set desired color or brightness.
- (4) Zone select: Up to 4 zones can be selected either independently or together. Once selected, the commands will be sent to the zone identified by a Blue LED.

Default DMX Addresses:

- 1 Warm
- 2 Cool

POP CORE SQUARE 1x1 LED

SURFACE-WALL - CHROMAWERX TUNABLE WHITE AND DIM TO WARM

750 LUMEN AT 80CRI - LOW OUTPUT

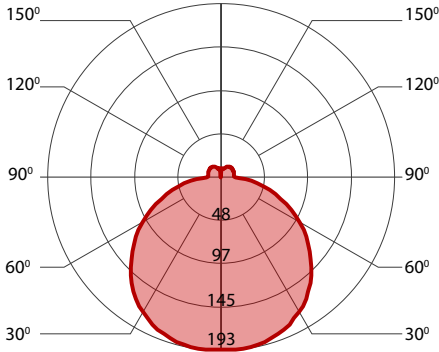

PERFORMANCE

LED output	Color Temp	Watts	Nominal Delivered Lumens	Efficacy LPW
low output	2700K	8	750	95
low output	3000K	7.5	750	97
low output	3500K	7.5	750	100
low output	4000K	7.5	750	103
low output	5000K	7	750	107
low output	6500K	7	750	107

900 LUMEN AT 80CRI - MEDIUM OUTPUT

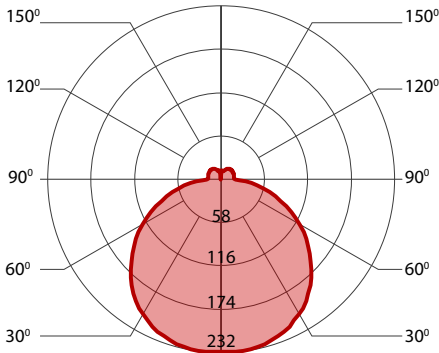

PERFORMANCE

LED output	Color Temp	Watts	Nominal Delivered Lumens	Efficacy LPW
medium output	2700K	9.5	900	96
medium output	3000K	9	900	99
medium output	3500K	9	900	102
medium output	4000K	8.5	900	105
medium output	5000K	8	900	109
medium output	6500K	8	900	109

1100 LUMEN AT 80CRI - HIGH OUTPUT

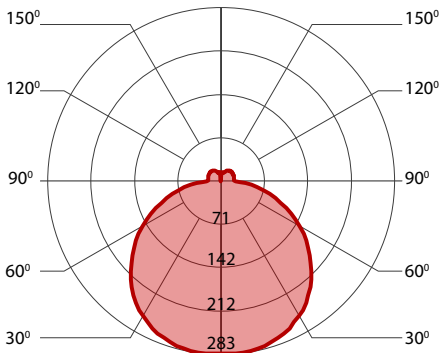

PERFORMANCE

LED output	Color Temp	Watts	Nominal Delivered Lumens	Efficacy LPW
high output	2700K	11.5	1100	97
high output	3000K	11	1100	99
high output	3500K	10.5	1100	103
high output	4000K	10.5	1100	106
high output	5000K	10	1100	110
high output	6500K	10	1100	110