

POP CORE ROUND 24 LED



LUMENWERX
WWW.LUMENWERX.COM

PENDANT DIRECT/INDIRECT - CHROMAWERX TUNABLE WHITE AND DIM TO WARM

IMPORTANT: a qualified DMX integration consultant is required to ensure proper installation and function of any DMX network



Shown with 3.5" optics



Shown with 5" optics

PROJECT: _____

TYPE: _____
NOTES: _____

DESCRIPTION

POP Core features a simple, uniformly luminous diffuser and delivers up to 122 LPW. The diffuser and light engine form a fully enclosed unit with no exposed hardware. POP Core is an ideal vehicle for ChromaWerx white tuning in education, office, and healthcare applications where modular luminaires are used.



up to 122 lm/w performance

ORDER GUIDE

POROPDI	24IN	ULO		LED		
LUMINAIRE ID	SIZE	OPTICS	HEIGHT	LIGHT SOURCE	CRI	DIRECT LUMEN PACKAGES
POROPDI - pop round pendant direct/indirect	24IN - Ø 24"	ULO - Uniform Lambertian Optic	3H - 3.5" optic 5H - 5" optic	LED - high performance LED	80 - 80CRI 90 - 90CRI	2500 - min. low output 2500lm 3500 - medium output 3500lm 4500 - max. high output 4500lm (80CRI only) #### - other required lm

INDIRECT LUMEN PACKAGES	CHROMAWERX	VOLTAGE	DRIVER	ELECTRICAL	MOUNTING
900 - min. medium output 900lm 1100 - max. high output 1100lm #### - other required lm	DUO - tunable white 2 channel control 27k to 65k SOLA - dim to warm single channel control 22k to 35k	120 - 120V 277 - 277V	DMX - to specify see pages 5 to 10 DA - Dali (duo only) local on-site commissioning is required O-10 - Single 0-10V input (Sola) or dual 0-10V input for CCT/Intensity (Duo) PSQO - Lutron T-Series 1% Tunable White (Duo only)	1 1 - 1 circuit	5WAC36 5WAC36 - power 5" white canopy (3/8" air craft cable) For all other options refer to our Pendant Mounting Guide

See page 2 for ordering code detailed information

FINISH	OPTIONS
W - matte white CF# - custom finish specify RAL#	FU120 - Fuse 120V FU277 - Fuse 277V CU - custom

DMX WALL CONTROLS
To specify see pages 5 to 10

CROSS SECTION

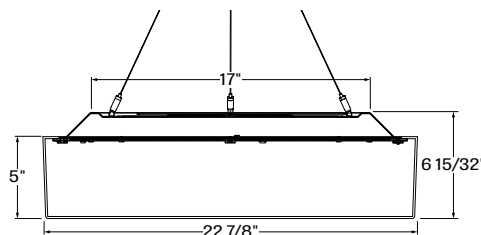
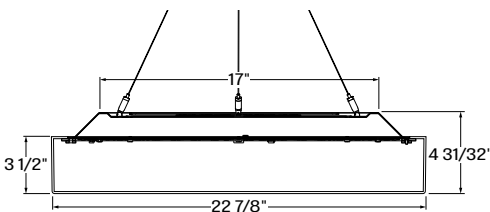

POROPDI + 3H - pop round pendant direct/indirect with 3.5" optics

POROPDI + 5H - pop round pendant direct/indirect with 5" optics



POP CORE ROUND 24 LED

PENDANT DIRECT/INDIRECT - CHROMAWERX TUNABLE WHITE AND DIM TO WARM

OPTICS

UNIFORM EFFICIENCY LAMBERTIAN OPTIC (ULO) - made of formed impact modified white PMMA, the optic provides an even light distribution with up to 88% transmission. Its unique enclosed shell design protects LEDs against Electrostatic Discharge and dust while its back surface project a soft glow on the mounting surface.

OPTICS HEIGHT

POP round pendant 24 is available with both 3.5" and 5" diffuser.

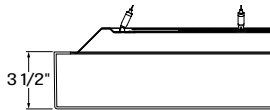

POROPDI + 3H - pop round pendant direct/indirect with 3.5" optics

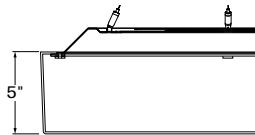

POROPDI + 5H - pop round pendant direct/indirect with 5" optics

LIGHT SOURCE - LED

PERFORMANCE AT 4000K

High Indirect Output (1100 Lumens)

LED output	Color Temp	Watts	Direct Lumens	Indirect Lumens	Total Nominal Delivered Lumens	Efficacy LPW
Low output	4000K	30	2500	1100	3600	121
Medium output	4000K	38.5	3500	1100	4600	120
High output	4000K	48.5	4500	1100	5600	116

Medium Indirect Output (900 Lumens)

LED output	Color Temp	Watts	Direct Lumens	Indirect Lumens	Total Nominal Delivered Lumens	Efficacy LPW
Low output	4000K	28	2500	900	3400	122
Medium output	4000K	36.5	3500	900	4400	120
High output	4000K	46.5	4500	900	5400	116

Lumen Adjustment Factors

2700K	0.917
3000K	0.959
3500K	0.988
4000K	1.000
6500K	1.053

Custom array of alternating color temperature mid-flux LED's are mounted directly to the housing for optimal thermal performance. For the Duo products, a color temperature range from 2700K-6500K is achievable with color points on or below the black body curve. For the Sola products, a color temperature range from 2200K-3500K is controlled synchronously with intensity. Color consistency between fixtures is maintained to within 3SDCM. LEDs are operated at reduced drive current to optimize efficacy and lumen maintenance.

All LED's have been tested in accordance with IESNA LM-80-08 and the results have shown L80 lumen maintenance greater than 60,000 hours. Absolute product photometry is measured and presented in accordance with IESNA LM-79, unless otherwise indicated.

CHROMAWERX - TUNABLE WHITE

ANSI C78.377-2015

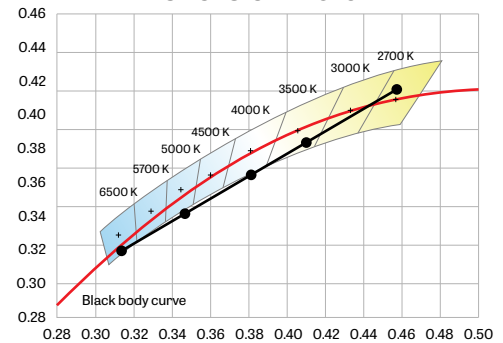

ChromaWerx Sola is single-channel control that dims output while warming the color temperature in a pre-determined relationship. A simple digital or analog control sends a common signal to dual output digital drivers, which are programmed to adjust a specially populated LED array to emulate the effect of dimming a filament source. Dimming range is programmable but the default option runs from 3500K at 100% of full power to 2200K at 5% of full power. CRI is maintained above 80 throughout the dimming range.

ChromaWerx Duo is a two-channel control. It uses analog or digital protocols for synchronous control of both warm and cool LED arrays, enabling the user to set color temperature and light output. Commonly called "tunable white", ChromaWerx two-channel control provides the range of warm (2700K) to cool (6500K) color that can be useful for helping to entrain circadian rhythms, stimulate alertness for improved educational and work productivity, and compensate for jet lag, among other applications. The ChromaWerx drivers are programmed to limit maximum light output and power usage across all color temperatures.

POP CORE ROUND 24 LED

PENDANT DIRECT/INDIRECT - CHROMAWERX TUNABLE WHITE AND DIM TO WARM

ELECTRICAL

DMX (Duo only)

Factory-Set adjustable output current electronic driver with 120-277V AC line input. Using DMX wall controls (optionally supplied by Lumenwerx) or an existing DMX control system, both channels of LEDs are independently adjustable. Each DMX driver can be independently addressed using the built-in RDM (Remote Device Management) in the field. Dimming down to 1% is attainable. Rated life (90% survivorship) of 50,000 hours at 50°C maximum ambient temperature. At maximum driver load, efficiency<84%, PF>0.9, THD<20%.

Dali (Duo Only)

Factory-Set adjustable output current electronic driver with 120-277V AC line input. Using an existing DALI control system (supplied by others), one control channel adjusts the fixture color temperature, and the other control channel adjusts fixture brightness. Dimming down to 1% is attainable. Rated life (90% survivorship) of 50,000 hours at 50°C maximum ambient temperature. At maximum driver load, efficiency<84%, PF>0.9, THD<20%.

0-10V (Sola)

Factory-set, adjustable output current LED driver with universal (120-277VAC) input. Using a single 0-10V control signal, the light output warms in color temperature as it dims down to 1% and 2200K. At maximum driver load, efficiency<86%, PF>0.9, THD<20%.

0-10V (Duo)

Factory-set adjustable output current LED driver with universal (120-277VAC) input. Controlled via two individual 0-10V signals, one for setting light output down to a minimum of 1% and the other for adjusting the CCT (default range of 2700K-6500K). Rated life of 50,000 hours at 70°C maximum driver case temperature and 100% load conditions. Typical efficiency of 86%, PF>0.9, THD<20% at 100% load conditions.

PSQ0 (Duo only)

Lutron T-Series 2-Channel tunable white drivers enable high-performance human centric lighting (HCL) applications. Digital control of color temperature (CCT) and intensity are achieved when used with the ESN T-Series tunable white controller as a part of a Lutron Quantum System.

MOUNTING OPTIONS

Fixtures are pendant-mounted, using aircraft cables. Unless otherwise specified, LumenWerx provides the following hardware:

For cable-mounted fixtures - 5WAC36, 5" white canopy with a 36" cable.

[For all other options, see our website for a detailed Pendant Mounting Guide](#)

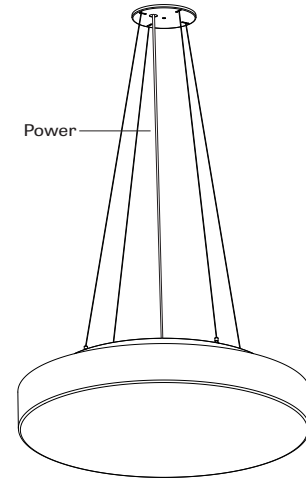

FINISH

Interior - 95% reflective, matte white powder coating

Exterior - matte white powder coating.

CONSTRUCTION

Housing - 16 gauge spun aluminum, matte white powder coating

Diffuser - Uniform lambertian optic, thermoformed impact modified acrylic, completely enclosed

WEIGHT

RD 24 X 3.5 - 13.42lbs - 6.1kg

RD 24 X 5 - 14.32lbs - 6.51kg

CERTIFICATIONS

ETL - Rated for Indoor Dry/Damp locations.

Conforms to UL Standard 1598 and certified to CAN/CSA Standard C22.2 No. 250.0.

POP CORE ROUND 24 LED

PENDANT DIRECT/INDIRECT - CHROMAWERX TUNABLE WHITE AND DIM TO WARM

WARRANTY

For all ChromaWerx products, LumenWerx provides a three-year limited warranty of electrical and mechanical performance of the luminaires, including the LED boards, drivers, and auxiliary electronics. LumenWerx will repair or replace defective luminaires or components at our discretion, provided they have been installed and operated in accordance with our specifications. Other limitations apply, please refer to the full warranty on our website.

Wall controllers are covered by the manufacturer warranty.

POP CORE ROUND 24 LED

PENDANT DIRECT/INDIRECT - CHROMAWERX TUNABLE WHITE

DUO DMX SPECIFICATION

A qualified DMX integrator is required to assure proper installation and commissioning of the DMX network. **When placing the PO, please provide the contact information of your DMX integrator.**

Please answer the following questions to help us identify your DMX network requirements.

YES

Do you require a wall controller provided by Lumenwerx?

NO

DMX control system supplied by others. Lumenwerx will supply DMX-enabled fixtures with default DMX addressing. See following pages for technical DMX informations. ✓

DMX controller supplied by Lumenwerx

How many zones do you have?

A zone consists of one or more luminaires behaving identically.

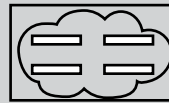

1 Zone



2 Zones

How to calculate the required number of drivers:

per 4' fixture

Driver

1x driver

Direct only

per 4' fixture

Driver Driver

2x driver

Direct high output

To Calculate # of drivers

1 - 4 Zones

5 or more Zones

Do you have more than 32 drivers in total?

NO

YES

Order a standard Lumenwerx wall controller.

WALL CONTROLLER

WCW - wall controller white
WCB - wall controller black

Add the control code at the end of your order code.

Please provide a fixture layout or RCP (Reflected Ceiling Plan) showing the locations of the DMX fixtures, zones and the DMX wall controller.

Refer to your DMX integrator for the installation. ✓

Subject to factory evaluation. Please contact our controls specialist at controls@lumenwerx.com. Additional cost and equipment will be required. ✓

Subject to factory evaluation and approval. Please contact our controls specialist at controls@lumenwerx.com. Additional cost and equipment will be required. ✓

POP CORE ROUND 24 LED

PENDANT DIRECT/INDIRECT - CHROMAWERX TUNABLE WHITE

GENERIC DMX NETWORK ARCHITECTURE

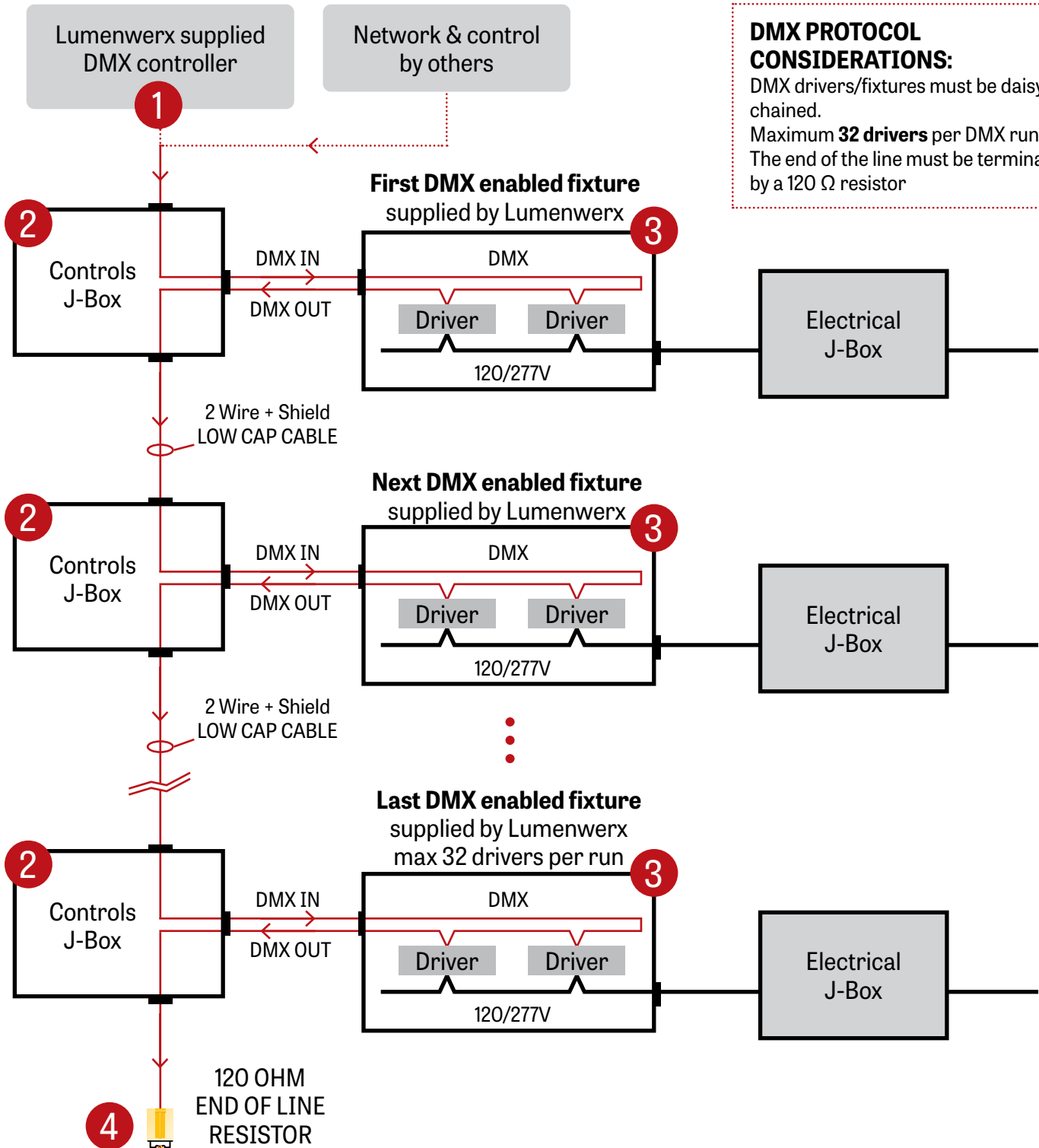

POP CORE ROUND 24 LED

PENDANT DIRECT/INDIRECT - CHROMAWERX TUNABLE WHITE

1 LUMENWERX SUPPLIED DMX CONTROLLER

To the first fixture

WALL BOX SUPPLIED BY OTHERS

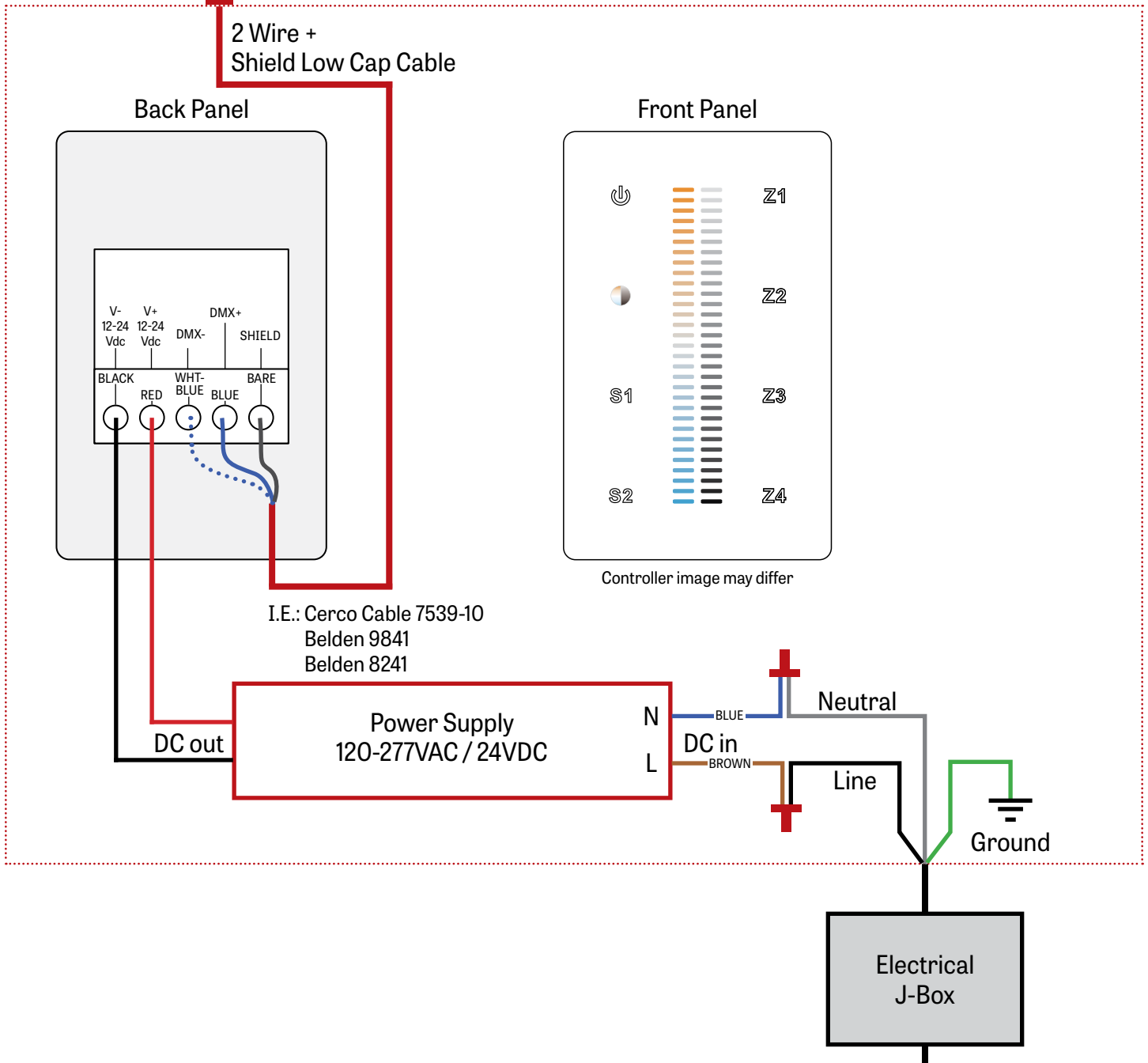

POP CORE ROUND 24 LED

PENDANT DIRECT/INDIRECT - CHROMAWERX TUNABLE WHITE

2 J-BOX DMX DAISY CHAIN DETAIL

Low capacitance DMX Cable from Previous Fixture

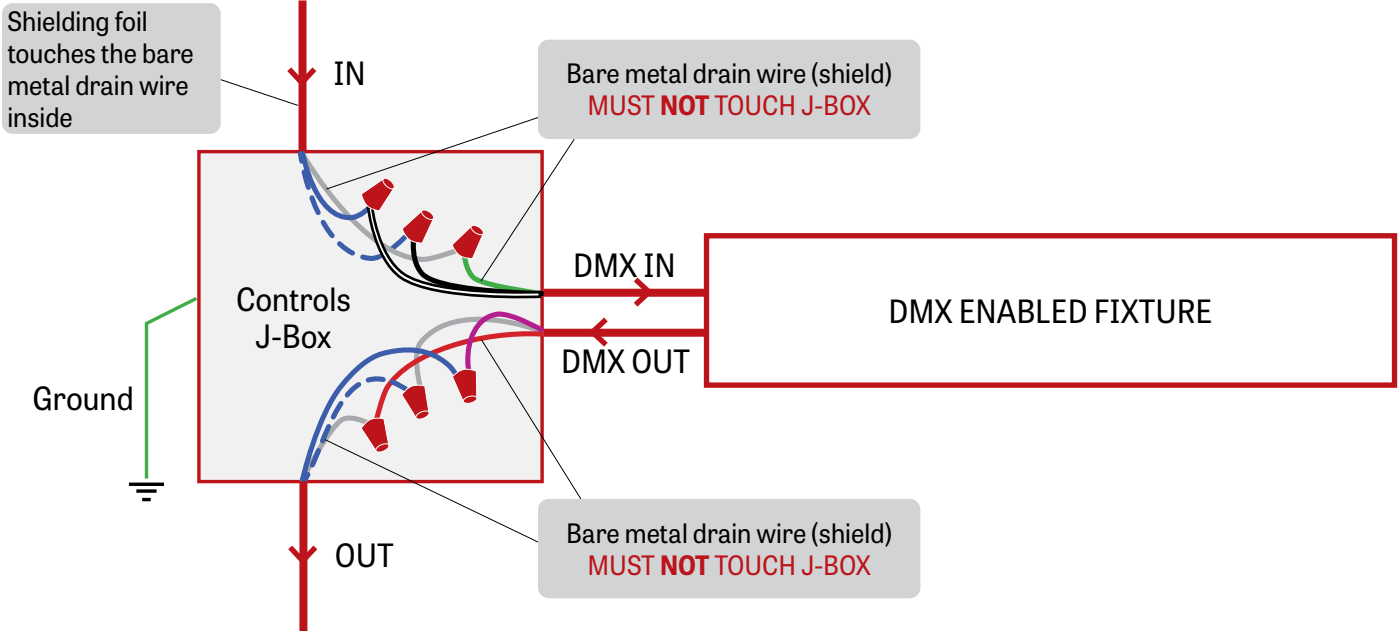

Low capacitance DMX cable to next fixture

3 DMX CONNECTION PENDANT & WALL

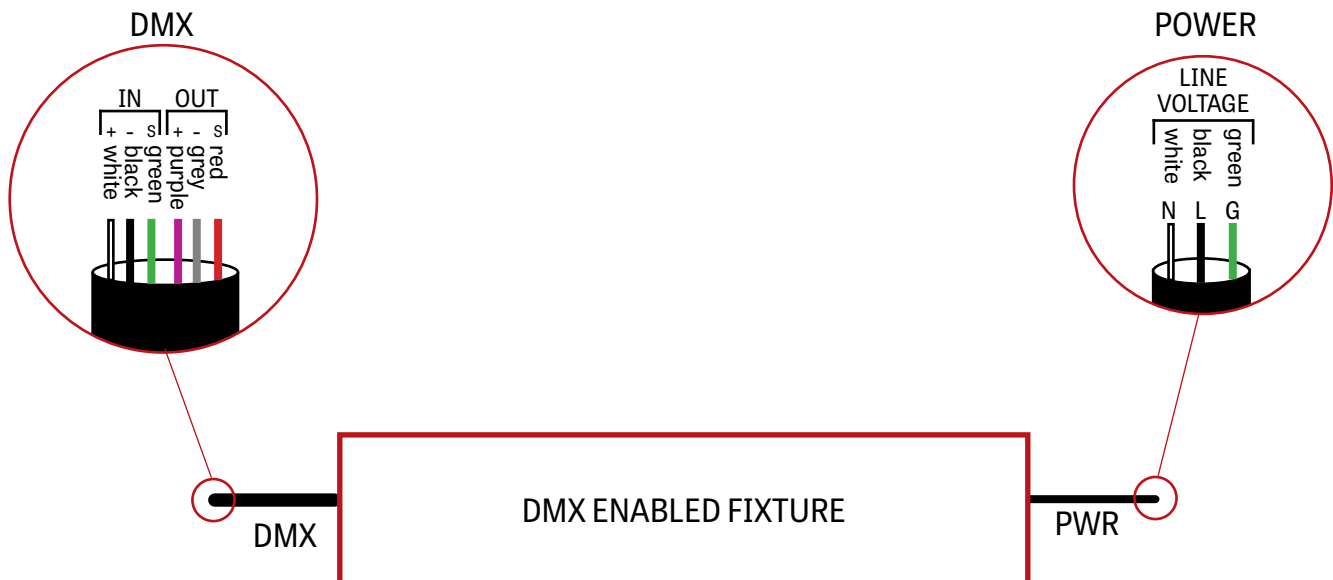

POP CORE ROUND 24 LED

PENDANT DIRECT/INDIRECT - CHROMAWERX TUNABLE WHITE

DMX WALL CONTROLLER

DUO 1-4 ZONE

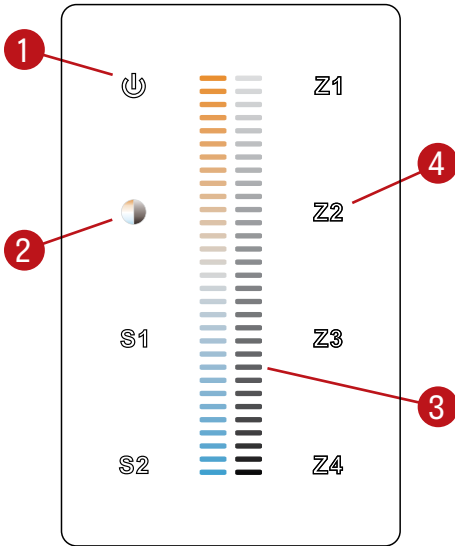

- (1) Power: Use this button to turn ON or OFF the fixture.
- (2) Brightness/CCT: Use the color/brightness toggle button to choose between color/brightness. When Blue: brightness is selected, when Yellow: color is selected.
- (3) Slider: Depending on the mode chosen in step 2, the slider will allow the user to set desired color or brightness.
- (4) Zone select: Up to 4 zones can be selected either independently or together. Once selected, the commands will be sent to the zone identified by a Blue LED.

Default DMX Addresses:

- 1 Warm
- 2 Cool

POP CORE ROUND 24 LED

PENDANT DIRECT/INDIRECT - CHROMAWERX TUNABLE WHITE AND DIM TO WARM

PERFORMANCE AT INDIRECT 900 LUMEN

2500 LUMEN AT 80CRI - LOW OUTPUT

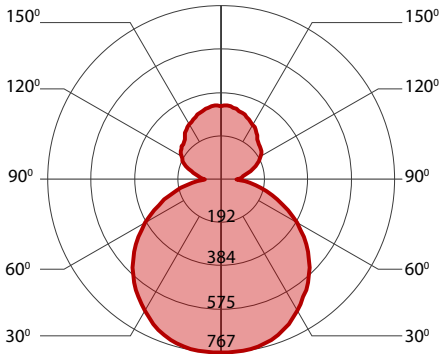

PERFORMANCE

LED output	Color Temp	Watts	Direct Lumens	Indirect Lumens	Total Nominal Delivered Lumens	Efficacy LPW
low output	2700K	30.5	2500	900	3400	112
low output	3000K	30	2500	900	3400	114
low output	3500K	29	2500	900	3400	118
low output	4000K	28	2500	900	3400	122
low output	5000K	27	2500	900	3400	126
low output	6500K	27	2500	900	3400	126

3500 LUMEN AT 80CRI - MEDIUM OUTPUT

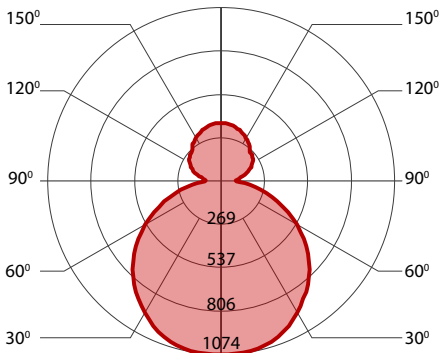

PERFORMANCE

LED output	Color Temp	Watts	Direct Lumens	Indirect Lumens	Total Nominal Delivered Lumens	Efficacy LPW
medium output	2700K	40	3500	900	4400	110
medium output	3000K	39.5	3500	900	4400	112
medium output	3500K	38	3500	900	4400	116
medium output	4000K	36.5	3500	900	4400	120
medium output	5000K	35	3500	900	4400	125
medium output	6500K	35.5	3500	900	4400	124

4500 LUMEN AT 80CRI - HIGH OUTPUT

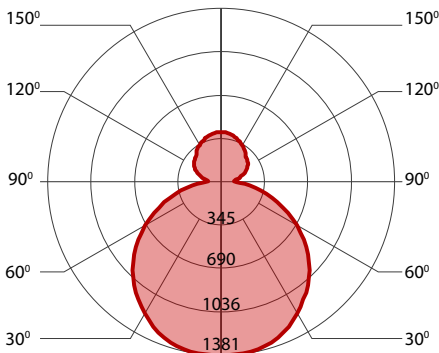

PERFORMANCE

LED output	Color Temp	Watts	Direct Lumens	Indirect Lumens	Total Nominal Delivered Lumens	Efficacy LPW
high output	2700K	50.5	4500	900	5400	107
high output	3000K	49.5	4500	900	5400	109
high output	3500K	48	4500	900	5400	113
high output	4000K	46.5	4500	900	5400	116
high output	5000K	44.5	4500	900	5400	121
high output	6500K	44.5	4500	900	5400	121

POP CORE ROUND 24 LED

PENDANT DIRECT/INDIRECT - CHROMAWERX TUNABLE WHITE AND DIM TO WARM

PERFORMANCE AT INDIRECT 1100 LUMEN

2500 LUMEN AT 80CRI - LOW OUTPUT

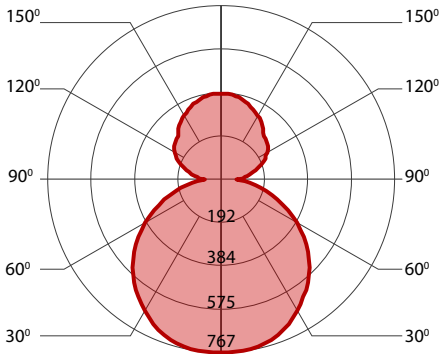

PERFORMANCE

LED output	Color Temp	Watts	Direct Lumens	Indirect Lumens	Total Nominal Delivered Lumens	Efficacy LPW
low output	2700K	32.5	2500	1100	3600	111
low output	3000K	31.5	2500	1100	3600	114
low output	3500K	31	2500	1100	3600	117
low output	4000K	30	2500	1100	3600	121
low output	5000K	28.5	2500	1100	3600	126
low output	6500K	28.5	2500	1100	3600	126

3500 LUMEN AT 80CRI - MEDIUM OUTPUT

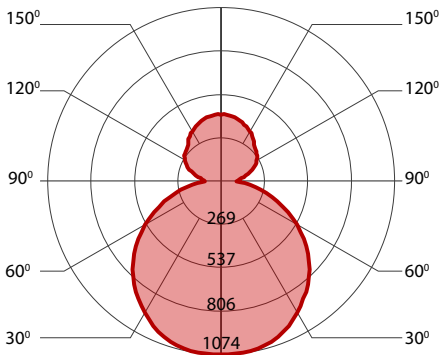

PERFORMANCE

LED output	Color Temp	Watts	Direct Lumens	Indirect Lumens	Total Nominal Delivered Lumens	Efficacy LPW
medium output	2700K	42	3500	1100	4600	110
medium output	3000K	41	3500	1100	4600	112
medium output	3500K	39.5	3500	1100	4600	116
medium output	4000K	38.5	3500	1100	4600	120
medium output	5000K	37	3500	1100	4600	125
medium output	6500K	37	3500	1100	4600	124

4500 LUMEN AT 80CRI - HIGH OUTPUT

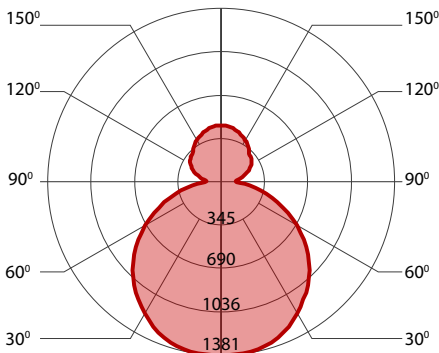

PERFORMANCE

LED output	Color Temp	Watts	Direct Lumens	Indirect Lumens	Total Nominal Delivered Lumens	Efficacy LPW
high output	2700K	52.5	4500	1100	5600	107
high output	3000K	51.5	4500	1100	5600	109
high output	3500K	49.5	4500	1100	5600	113
high output	4000K	48.5	4500	1100	5600	116
high output	5000K	46.5	4500	1100	5600	121
high output	6500K	46.5	4500	1100	5600	121