

POP CORE SQUARE 2x2 LED

PENDANT DIRECT

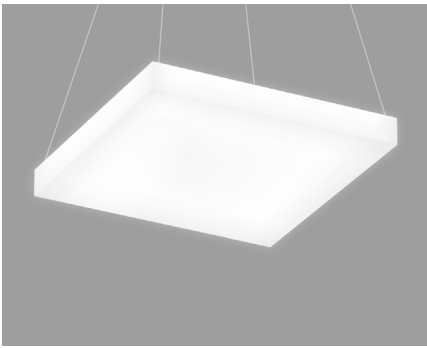

Shown with 2.5" optic

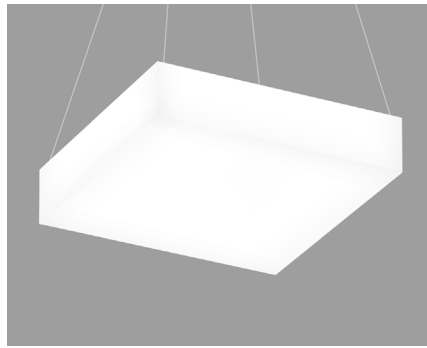

Shown with 5" optic

PROJECT: _____

TYPE: _____

NOTES: _____



DESCRIPTION

POP Core features a simple, uniformly luminous diffuser and delivers up to 114 LPW. The diffuser and light engine form a fully enclosed unit secured by a twist-and-lock mechanism for easy maintenance with no exposed hardware.

ORDER GUIDE

up to 114 lm/W performance

POSQPD	2FTX2FT	ULO	HEIGHT	SW		
LUMINAIRE ID	SIZE	OPTIC	HEIGHT	LIGHT SOURCE	CRI	LUMEN PACKAGE
POSQPD - Pop Square Pendant Direct	2FTX2FT - 2' X 2'	ULO - Uniform Lambertian Optic	2H - 2.5" optic 5H - 5" optic	SW - Static white	80 - 80CRI 90 - 90CRI	2500 - Min. low output 2500lm 3500 - Medium output 3500lm 4500 - Max. high output 4500lm #### - Other required lm

COLOR TEMP.	VOLTAGE	DRIVER	ELECTRICAL	5SWAC36 MOUNTING	FINISH	OPTIONS
27 - 2700K 30 - 3000K 35 - 3500K 40 - 4000K	120 - 120V 277 - 277V UNV - 120V-277V 347 - 347V	D1 - 1% 0-10V DA - DALI LDE1 - Lutron Hi-Lume 1% Eco	1 - 1 circuit +GTD - Generator transfer device	5SWAC36 - Power 5" square white canopy (36" aircraft cable) For all other options refer to our Pendant Mounting Guide	W - Matte white CF# - Custom finish specify RAL#	FU120 - Fuse 120V FU277 - Fuse 277V

See page 3 for ordering code detailed information

CROSS SECTION

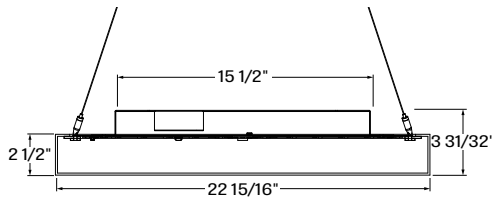

POSQPD + 2H - Pop Square Pendant with 2.5" optic

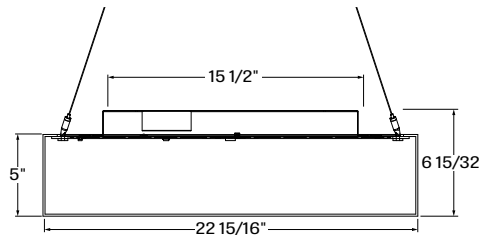

POSQPD + 5H - Pop Square Pendant with 5" optic

POP CORE SQUARE 2x2 LED

PENDANT DIRECT

POP SQUARE 2H - 2.5" OPTIC

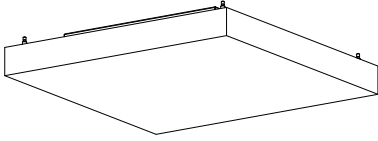

POP SQUARE 5H - 5" OPTIC

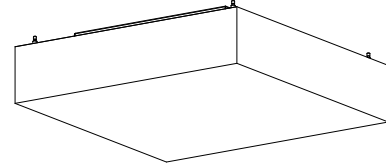

POSQPD + 2H - Pop Square Pendant with 2.5" optic

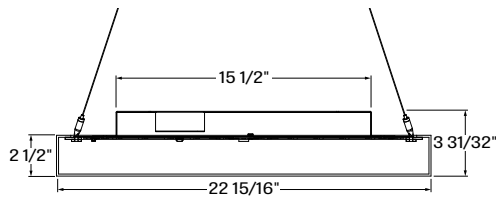

POSQPD + 5H - Pop Square Pendant with 5" optic

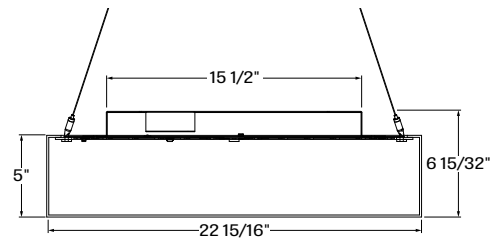

POP CORE SQUARE 2x2 LED

PENDANT DIRECT

OPTIC

Uniform Efficiency Lambertian Optic (ULO) - Made of formed impact modified white PMMA, the optic provides an even light distribution with up to 88% transmission. Its unique enclosed shell design protects LEDs against Electrostatic Discharge and dust while its back surface project a soft glow on the mounting surface.

OPTICS HEIGHT

Pop Square Pendant 22 is available with both 2.5" and 5" diffuser.

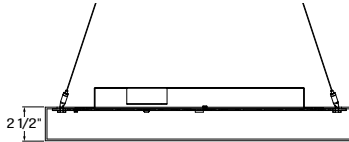

POSQPD + 2H - Pop Square Pendant with 2.5" optic

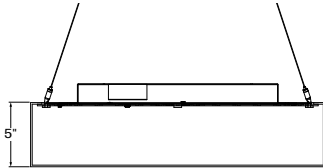

POSQPD + 5H - Pop Square Pendant with 5" optic

LIGHT SOURCE

Custom array of mid-flux LEDs are mounted directly to the housing for optimal thermal performance. Available in 2700K, 3000K, 3500K and 4000K with a minimum 80 CRI and an option for 90 CRI with elevated R9 value. Color consistency maintained to within 3 SDCM. LEDs operated at reduced drive current to optimize efficacy and lumen maintenance.

All LEDs have been tested in accordance with IESNA LM-80-08 and the results have shown L80 lumen maintenance greater than 60,000 hours. Absolute product photometry is measured and presented in accordance with IESNA LM-79, unless otherwise indicated.

PERFORMANCE AT 4000K

LED output	Color Temp	Watts	Nominal Delivered Lumens	Efficacy LPW
Low output	4000K	22	2500	114
Medium output	4000K	32	3500	108
High output	4000K	42	4500	107

ELECTRICAL

Factory-set, adjustable output current LED driver with universal (120-277VAC) input. Dimmable from 100% to 1% with 0-10V dimming control. Rated life (90% survivorship) of 50,000 hours at 50°C max. ambient (and 70°C max. case) temperature. At maximum driver load: Efficiency>84%, PF>0.9, THD<20%. Other specifiable options include Hi-Lume 1% Eco and DALI protocol drivers. All of our standard 0-10V drivers are NEMA 410 compliant.

MOUNTING OPTIONS

Fixtures are pendant-mounted, using aircraft cables. Unless otherwise specified, Lumenwerx provides the following hardware:

For cable-mounted fixtures - 5SWAC36, 5" square white canopy with a 36" cable.

[For all other options, see our website for a detailed Pendant Mounting Guide](#)

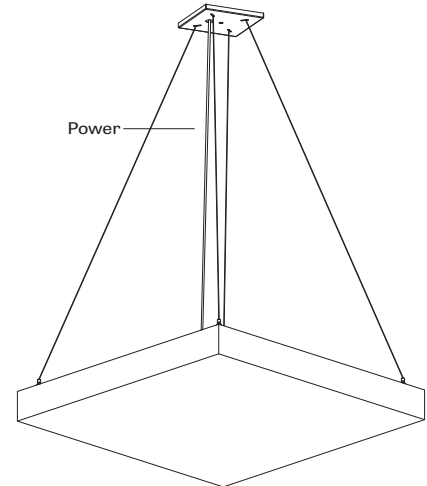

FINISH

Interior - 95% reflective, matte white powder coating

Exterior - Matte white powder coating.

CONSTRUCTION

Housing - 16 gauge spun aluminum, matte white powder coating

Diffuser - Uniform Lambertian Optic, precisely formed impact modified acrylic, completely enclosed

WEIGHT

SQ 22 X 2.5 - 15.68lbs - 7.12kg

SQ 22 X 5 - 16.88lbs - 7.67kg

CERTIFICATIONS

ETL - Rated for Indoor Dry/Damp locations.

Conforms to UL Standard 1598 and certified to CAN/CSA Standard C22.2 No. 250.0.

POP CORE SQUARE 2x2 LED

PENDANT DIRECT

WARRANTY

Lumenwerx provides a five-year limited warranty of electrical and mechanical performance of the luminaires, including the LED boards, drivers, and auxiliary electronics. Lumenwerx will repair or replace defective luminaires or components at our discretion, provided they have been installed and operated in accordance with our specifications. Other limitations apply, please refer to the full warranty on our website.

POP CORE SQUARE 2x2 LED

PENDANT DIRECT

2500 LUMEN AT 80CRI - LOW OUTPUT

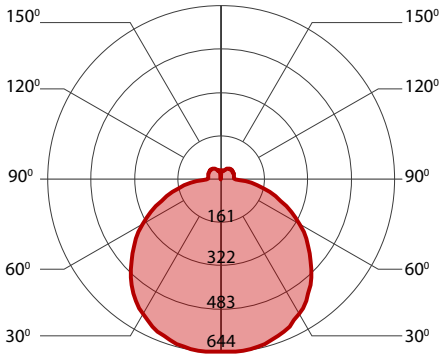

PERFORMANCE

LED output	Color Temp	Watts	Nominal Delivered Lumens	Efficacy LPW
Low output	2700K	24	2500	105
Low output	3000K	23.5	2500	107
Low output	3500K	22.5	2500	110
Low output	4000K	22	2500	114

3500 LUMEN AT 80CRI - MEDIUM OUTPUT

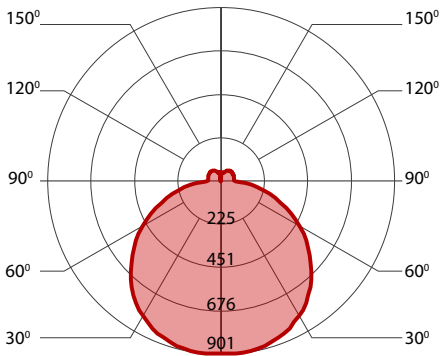

PERFORMANCE

LED output	Color Temp	Watts	Nominal Delivered Lumens	Efficacy LPW
Medium output	2700K	35.5	3500	99
Medium output	3000K	34.5	3500	101
Medium output	3500K	33.5	3500	105
Medium output	4000K	32	3500	108

4500 LUMEN AT 80CRI - HIGH OUTPUT

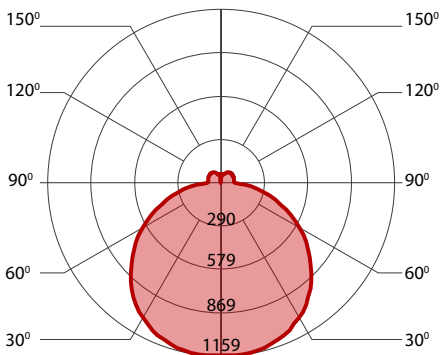

PERFORMANCE

LED output	Color Temp	Watts	Nominal Delivered Lumens	Efficacy LPW
High output	2700K	46	4500	98
High output	3000K	45	4500	100
High output	3500K	43.5	4500	104
High output	4000K	42	4500	107