

POP RECESSED

ROUND 12
CHROMAWERX SOLA AND DUO

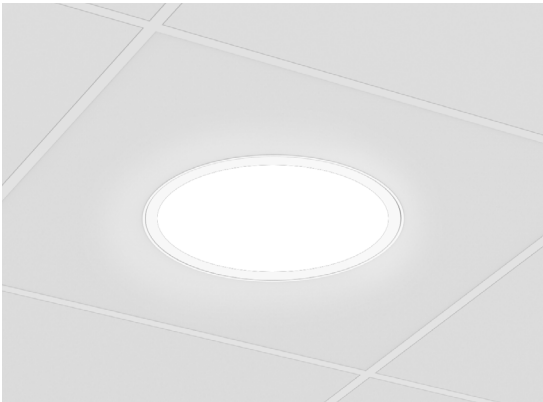

Lumenwerx



Flush lens

Project: _____

Type: _____

DESCRIPTION

POP Recessed features a uniformly luminous diffuser that sits flush with the ceiling. The diffuser and light engine form a fully enclosed unit secured by a twist-and-lock mechanism for easy maintenance with no exposed hardware. POP Recessed delivers up to 101 LPW and installs in grid or gypsum board ceilings. POP Recessed is an ideal vehicle for Chromawerx white tuning in education, office, and healthcare applications where modular luminaires are used.



IC RATED

Order Guide

Up to 101 lm/W performance

| LUMINAIRE ID | SIZE | OPTIC | LENS | LIGHT SOURCE | CRI | LUMEN PACKAGE |
|---|--------------------|--|-------------------|--|--|--|
| | 12IN | | FH | | | |
| POROR ¹ - Pop Round Recessed POSEALROR ^{1,2} - Pop Seal Round Recessed ¹ IK10 rated when specified with PTR optic. ² IP54 rated when specified with drywall ceiling mounting option. | 12IN - Ø12" | ULO ³ - Uniform Lambertian Optic ATR ⁴ - Acrylic lens with tamper-resistant screws PTR - Polycarbonate lens with tamper-resistant screws ³ Not available with Pop Seal model (POSEALROR). ⁴ Only available with Pop Seal model (POSEALROR). | FH - Flush | SOLA - Dim-to-warm single channel control 35K to 22K DUO - Tunable white 2-channel control 27K to 65K | 80 - 80CRI 90 - 90CRI | 750 - Min. low output 750lm 900 - Medium output 900lm 1100 - Max. high output 1100lm #### - Other required lm |

| VOLTAGE | DRIVER ⁵ | ELECTRICAL | MOUNTING | FINISH | OPTIONS |
|--|---|----------------------|---|---|--|
| | | 1 | | | |
| 120 - 120V 277 - 277V | DMX ⁶ - To specify see pages 5 to 10 DA ⁶ - DALI (duo only) local on-site commissioning is required 0-10 - Single 0-10V input (Sola) or dual 0-10V input for CCT/Intensity (Duo) PSQO ⁶ - Lutron T-Series 1% Tunable White (Duo only) ⁵ PoE (Power-over-Ethernet) compatible. Consult factory for details. ⁶ On-site commissioning is required. | 1 - 1 circuit | TC9 - Tegular 9/16" TC15 - Tegular 15/16" TB9 - T-Bar 9/16" TB15 - T-Bar 15/16" ST - Screw slot t-bar DF - Drywall kit | W - Matte white WA - White antimicrobial Silverwerx | FU120 - Fuse 120V FU277 - Fuse 277V CP - Chicago Plenum NA - None |

CROSS SECTION

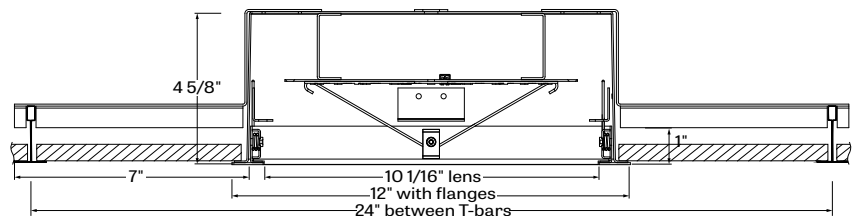

POROR + FH - pop round recessed with flush lens

3737 Cote Vertu St-Laurent, Quebec, Canada H4R 2C9
 T (514) 225-4304 F (514) 931-4862
www.lumenwerx.com



Lumenwerx reserves the right to modify product specifications without notification.
 © Lumenwerx, ULC. All rights reserved.
 POPRECESSED-12-TW-ROUND-RECESSED-SPEC-REV2.5- February 10, 2026



POP RECESSED

ROUND 12

CHROMAWERX SOLA AND DUO



Photometrics

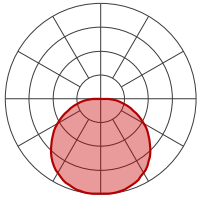

750 LUMEN AT 80 CRI - LOW OUTPUT

| LED OUTPUT | COLOR TEMP | WATTS | NOMINAL DELIVERED LUMENS | EFFICACY LPW |
|------------|------------|-------|--------------------------|--------------|
| Low output | 2700K | 8 | 750 | 93 |
| Low output | 3000K | 8 | 750 | 95 |
| Low output | 3500K | 7.5 | 750 | 98 |
| Low output | 4000K | 7.5 | 750 | 101 |

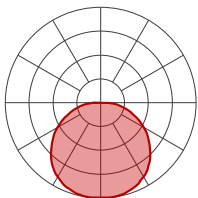

900 LUMEN AT 80 CRI - MEDIUM OUTPUT

| LED OUTPUT | COLOR TEMP | WATTS | NOMINAL DELIVERED LUMENS | EFFICACY LPW |
|---------------|------------|-------|--------------------------|--------------|
| Medium output | 2700K | 10 | 900 | 91 |
| Medium output | 3000K | 9.5 | 900 | 93 |
| Medium output | 3500K | 9.5 | 900 | 96 |
| Medium output | 4000K | 9 | 900 | 99 |

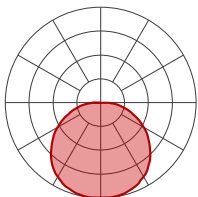

1100 LUMEN AT 80 CRI - HIGH OUTPUT

| LED OUTPUT | COLOR TEMP | WATTS | NOMINAL DELIVERED LUMENS | EFFICACY LPW |
|-------------|------------|-------|--------------------------|--------------|
| High output | 2700K | 11.5 | 1100 | 95 |
| High output | 3000K | 11.5 | 1100 | 94 |
| High output | 3500K | 11.5 | 1100 | 97 |
| High output | 4000K | 11 | 1100 | 100 |

POP RECESSED

ROUND 12

CHROMAWERX SOLA AND DUO



Technical Specifications

OPTICS

UNIFORM EFFICIENCY LAMBERTIAN OPTIC (ULO) - made of formed impact modified white PMMA, the optic provides an even light distribution with up to 88% transmission. Its unique enclosed shell design protects LEDs against Electrostatic Discharge and dust while its back surface project a soft glow on the mounting surface.

LIGHT SOURCE

Custom array of alternating color temperature mid-flux LEDs are mounted directly to the housing for optimal thermal performance. For the Duo products, a color temperature range from 2700K-6500K is achievable with color points on or below the black body curve. For the Sola products, a color temperature range from 3500K-2200K is controlled synchronously with intensity. Color consistency between fixtures is maintained to within 3SDCM. LEDs are operated at reduced drive current to optimize efficacy and lumen maintenance.

All LEDs have been tested in accordance with IESNA LM-80-08 and the results have shown L80 lumen maintenance greater than 60,000 hours. Absolute product photometry is measured and presented in accordance with IESNA LM-79, unless otherwise indicated.

CHROMAWERX - TUNABLE WHITE

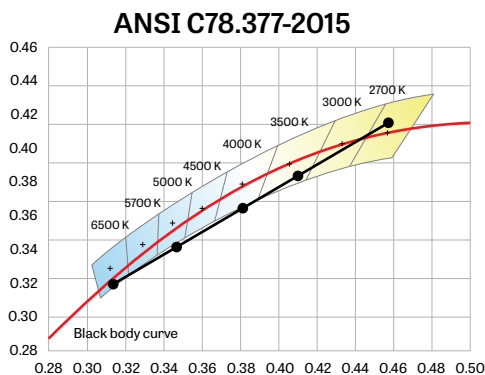

Chromawerx Sola is single-channel control that dims output while warming the color temperature in a pre-determined relationship. A simple digital or analog control sends a common signal to dual output digital drivers, which are programmed to adjust a specially populated LED array to emulate the effect of dimming a filament source. Dimming range is programmable but the default option runs from 3500K at 100% of full power to 2200K at 5% of full power. CRI is maintained above 80 throughout the dimming range.

Chromawerx Duo is two-channel control. It uses an analog (0-10V) protocol for separate control of luminaire CCT and intensity or a digital (DMX, DALI) protocol for synchronous control of both warm and cool LED arrays to enable the user to set color temperature and light output. Commonly called “tunable white”, Chromawerx two-channel control provides the range of warm (2700K) to cool (6500K) color that can be useful for helping to entrain circadian rhythms, stimulate alertness for improved educational and work productivity, and compensate for jet lag, among other applications. The Chromawerx drivers are programmed to limit maximum light output and power usage across all color temperatures. CRI is maintained above 80.

ELECTRICAL

DMX (Duo only)

Factory-Set adjustable output current electronic driver with 120-277V AC line input. Using DMX wall controls (optionally supplied by Lumenwerx) or an existing DMX control system, both channels of LEDs are independently adjustable. Each DMX driver can be independently addressed using the built-in RDM (Remote Device Management) in the field. Dimming down to 1% is attainable. Rated life (90% survivorship) of 50,000 hours at 50°C maximum ambient temperature. At maximum driver load, efficiency<84%, PF>0.9, THD<20%.

Dali (Duo Only)

Factory-Set adjustable output current electronic driver with 120-277V AC line input. Using an existing DALI control system (supplied by others), one control channel adjusts the fixture color temperature, and the other control channel adjusts fixture brightness. Dimming down to 1% is attainable. Rated life (90% survivorship) of 50,000 hours at 50°C maximum ambient temperature. At maximum driver load, efficiency<84%, PF>0.9, THD<20%.

0-10V (Sola)

Factory-set, adjustable output current LED driver with universal (120-277VAC) input. Using a single 0-10V control signal, the light output warms in color temperature as it dims down to 1% and 2200K. At maximum driver load, efficiency<86%, PF>0.9, THD<20%.

0-10V (Duo)

Factory-set adjustable output current LED driver with universal (120-277VAC) input. Controlled via two individual 0-10V signals, one for setting light output down to a minimum of 1% and the other for adjusting the CCT (default range of 2700K-6500K). Rated life of 50,000 hours at 70°C maximum driver case temperature and 100% load conditions. Typical efficiency of 86%, PF>0.9, THD<20% at 100% load conditions.

POP RECESSED

ROUND 12

CHROMAWERX SOLA AND DUO



PSQO (Duo only)

Lutron T-Series 2-Channel tunable white drivers enable high-performance human centric lighting (HCL) applications. Digital control of color temperature (CCT) and intensity are achieved when used with the ESN T-Series tunable white controller as a part of a Lutron Quantum System.

PoE

Depending on the PoE manufacturer selected, Lumenwerx will install the node in factory as either integral to the luminaire or as a remote module. Factory programming of the PoE node may or may not enable the following functionalities: lumen package, Duo (tunable white), emergency battery backup, and sensor integration. These must be addressed and evaluated on a case-by-case basis.

MOUNTING OPTIONS

Recess mount into exposed or concealed T-Bar or Tegular grid ceiling. A separate kit for mounting fixtures into drywall ceilings

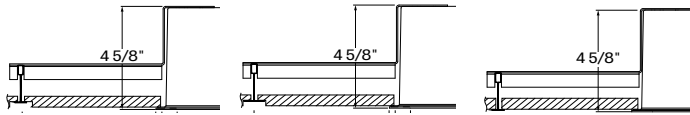

TG9 - tegular 9/16"

TG15 - tegular 15/16"

TB9 - t-bar 9/16"

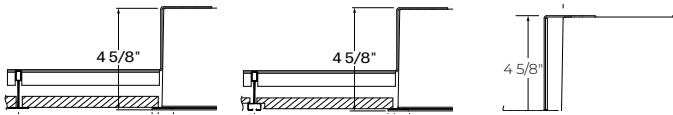

TB15 - t-bar 15/16"

ST - screw slot t-bar

DF - drywall kit

FINISH

Interior - 95% reflective, matte white powder coating

Exterior - matte white powder coating. Optional antimicrobial finish

POP SEAL OPTION

The lens is gasketed and sealed, making the fixture suitable for healthcare applications. IP54 rated when specified with the drywall ceiling mounting option.

CONSTRUCTION

Housing - 16 gauge spun aluminum, matte white powder coating

Diffuser - Uniform Lambertian optic, thermoformed impact modified acrylic, completely enclosed

Gasket (Pop Seal) - Closed-cell silicone foam gasket

WEIGHT

RD 12 Flush - 4.24lbs - 1.93kg

CERTIFICATIONS

ETL - Rated for Indoor Dry/Damp locations. Conforms to UL Standard 1598 and certified to CAN/CSA Standard C22.2 No. 250.0.

Chicago plenum - City of Chicago Approved (CCEA)

IC rated - suitable for direct contact with insulation.

NSF - NSF2 Listed for Non-Food Zones.

WARRANTY

Lumenwerx provides a five-year limited warranty of electrical and mechanical performance of the luminaires, including the LED boards, drivers, and auxiliary electronics. Lumenwerx will repair or replace defective luminaires or components at our discretion, provided they have been installed and operated in accordance with our specifications. Other limitations apply, please refer to the full warranty on our website.

Wall controllers are covered by the manufacturer warranty.

POP RECESSED

ROUND 12

CHROMAWERX SOLA AND DUO



DUO DMX SPECIFICATION

A qualified DMX integrator is required to assure proper installation and commissioning of the DMX network. **When placing the PO, please provide the contact information of your DMX integrator.**

Please answer the following questions to help us identify your DMX network requirements.

YES

Do you require a wall controller provided by Lumenwerx?

NO

DMX control system supplied by others. Lumenwerx will supply DMX-enabled fixtures with default DMX addressing. See following pages for technical DMX informations. ✓

DMX controller supplied by Lumenwerx

How many zones do you have?

A zone consists of one or more luminaires behaving identically.



1 Zone



2 Zones

How to calculate the required number of drivers:

per 4' fixture

Driver

1x driver

Direct only

per 4' fixture

Driver

Driver

2x driver

Direct high output

To Calculate # of drivers

NO

YES

Do you have more than 32 drivers in total?

Order a standard Lumenwerx wall controller.

WALL CONTROLLER

WCW - wall controller white

WCB - wall controller black

Add the control code at the end of your order code.

Please provide a fixture layout or RCP (Reflected Ceiling Plan) showing the locations of the DMX fixtures, zones and the DMX wall controller.

Refer to your DMX integrator for the installation. ✓

Subject to factory evaluation. Please contact our controls specialist at controls@lumenwerx.com. Additional cost and equipment will be required. ✓

Subject to factory evaluation and approval. Please contact our controls specialist at controls@lumenwerx.com. Additional cost and equipment will be required. ✓

POP RECESSED

ROUND 12

CHROMAWERX SOLA AND DUO



GENERIC DMX NETWORK ARCHITECTURE

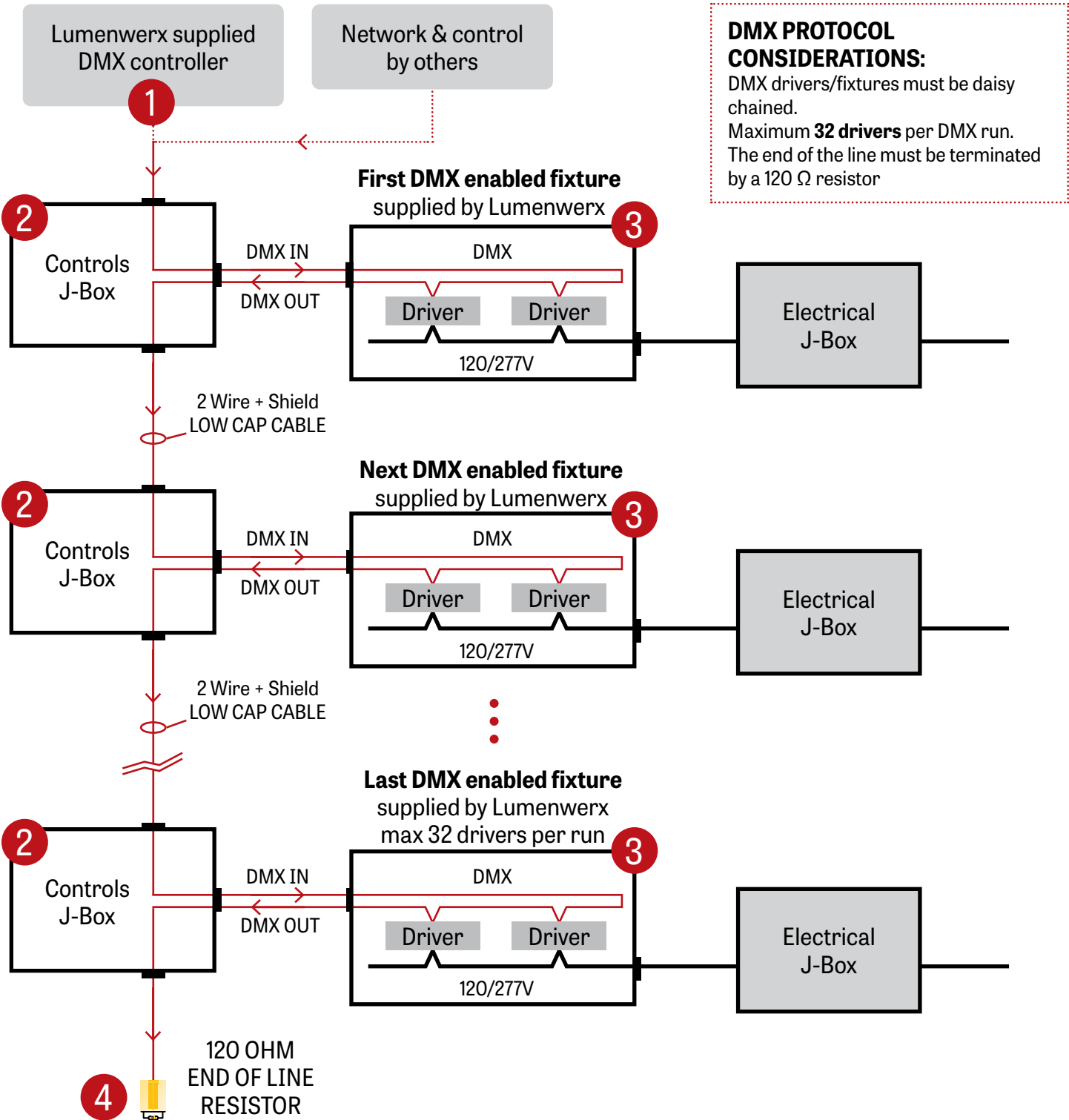

POP RECESSED

ROUND 12

CHROMAWERX SOLA AND DUO



1 LUMENWERX SUPPLIED DMX CONTROLLER

To the first fixture



2 Wire +
Shield Low Cap Cable

WALL BOX SUPPLIED BY OTHERS

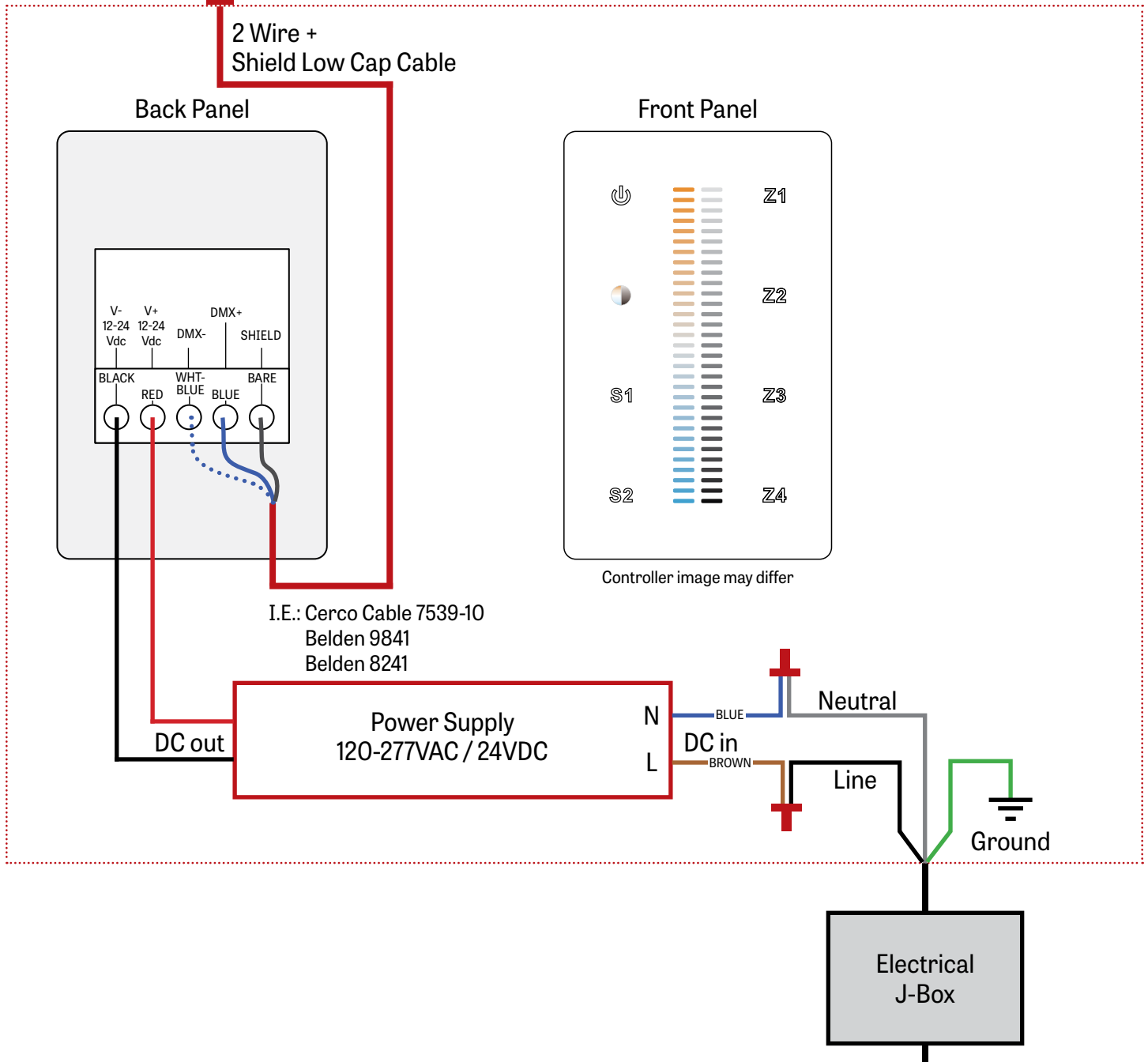

I.E.: Cerco Cable 7539-10
Belden 9841
Belden 8241

Power Supply
120-277VAC / 24VDC

Controller image may differ

Electrical
J-Box

POP RECESSED

ROUND 12

CHROMAWERX SOLA AND DUO

2 J-BOX DMX DAISY CHAIN DETAIL

Low capacitance DMX Cable from Previous Fixture

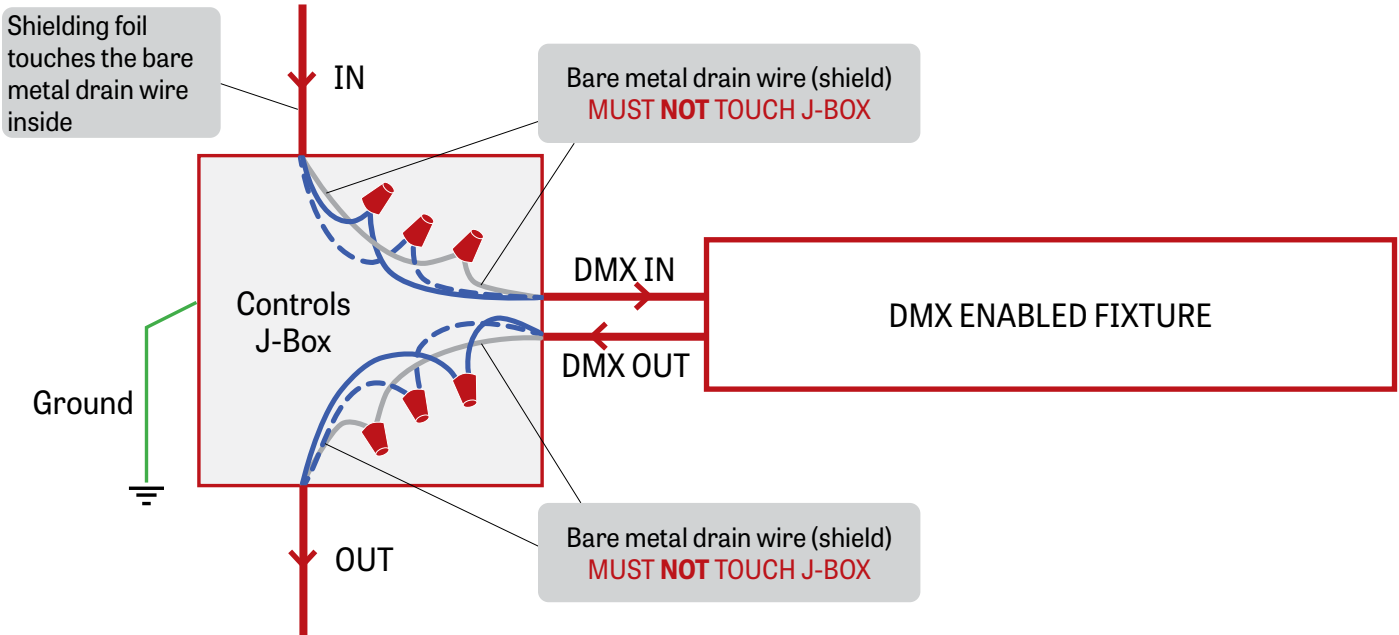

Low capacitance DMX cable to next fixture

3 DMX CONNECTION RECESSED & SURFACE

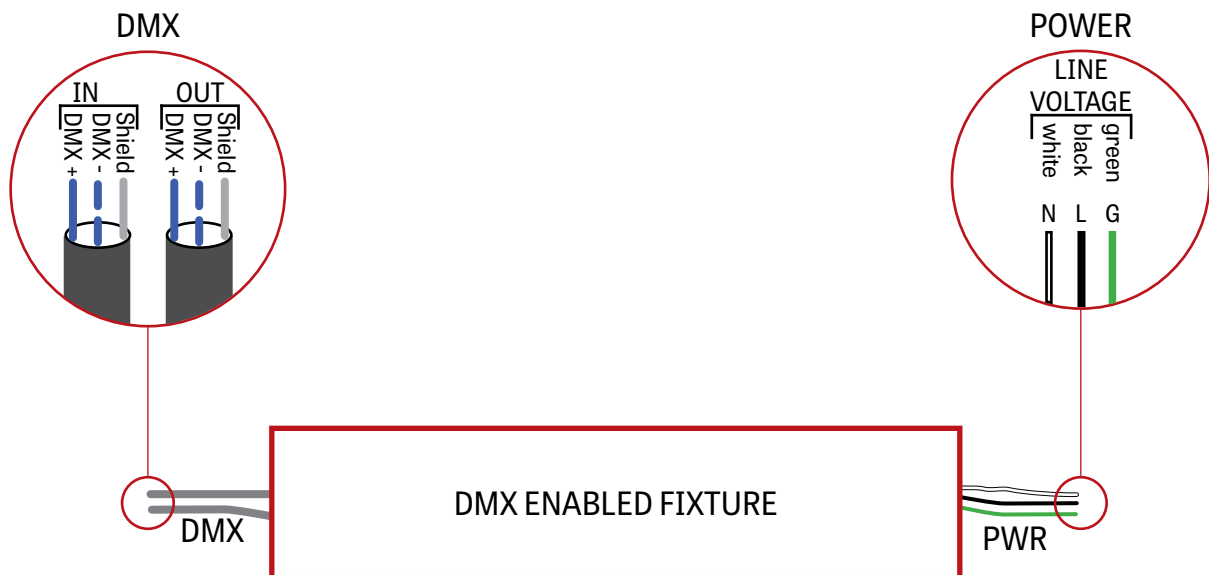

POP RECESSED



ROUND 12
CHROMAWERX SOLA AND DUO

4 DMX LAST FIXTURE DETAIL

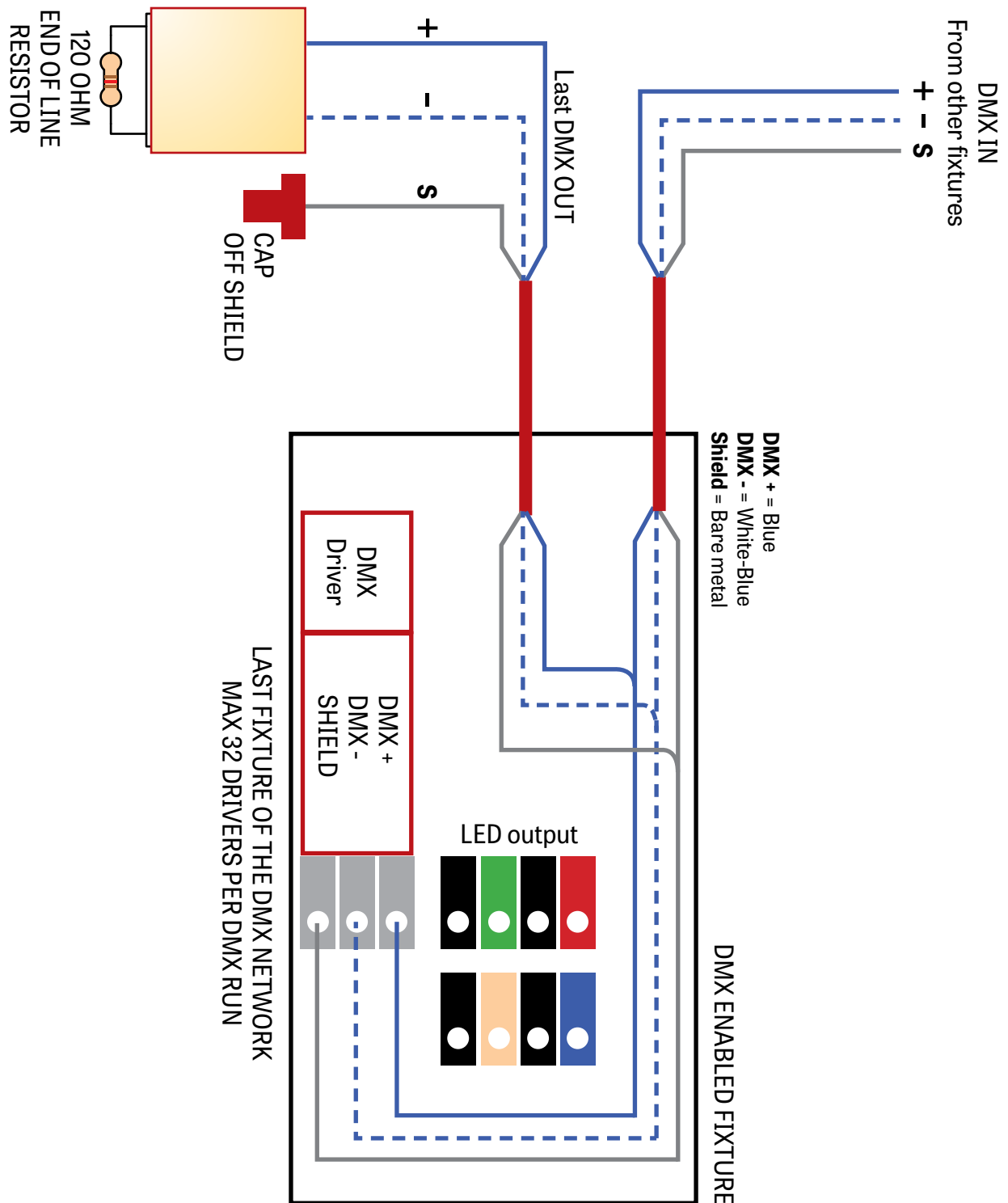

POP RECESSED

ROUND 12

CHROMAWERX SOLA AND DUO



DMX WALL CONTROLLER

DUO 1-4 ZONE

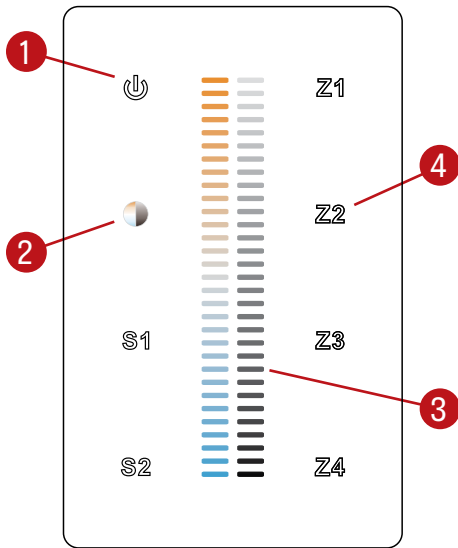

- (1) Power: Use this button to turn ON or OFF the fixture.
- (2) Brightness/CCT: Use the color/brightness toggle button to choose between color/brightness. When Blue: brightness is selected, when Yellow: color is selected.
- (3) Slider: Depending on the mode chosen in step 2, the slider will allow the user to set desired color or brightness.
- (4) Zone select: Up to 4 zones can be selected either independently or together. Once selected, the commands will be sent to the zone identified by a Blue LED.

Default DMX Addresses:

- 1 Warm
- 2 Cool