

# POP RECESSED

SQUARE 2X2

CHROMAWERX SOLA AND DUO

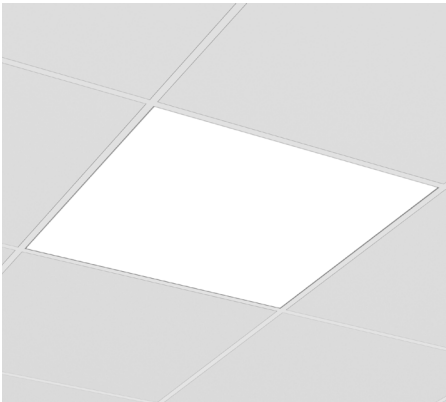

Flush lens



Drop 1" lens



Drop 2" lens



Drop 3" lens



Drop 4" lens

Project: \_\_\_\_\_

Type: \_\_\_\_\_

POP Recessed features a uniformly luminous diffuser that sits flush with the ceiling or drops up to 4" below. The diffuser and light engine form a fully enclosed unit secured by a twist-and-lock mechanism for easy maintenance with no exposed hardware. POP Recessed delivers up to 110 LPW and installs in grid or gypsum board ceilings. POP Recessed is an ideal vehicle for Chromawerx white tuning in education, office, and healthcare applications where modular luminaires are used.

IC RATED

IP54



Up to 110 lm/W performance

## Order Guide

LUMINAIRE ID	SIZE	OPTIC	LENS	LIGHT SOURCE	CRI	LUMEN PACKAGE
	<b>2FTX2FT</b>					
<b>POSQR</b> <sup>1</sup> - Pop Square Recessed <b>POSEALSQR</b> <sup>1,2</sup> - Pop Seal Square Recessed  <sup>1</sup> IK10 rated when specified with PTR optic. <sup>2</sup> IP54 rated when specified with drywall ceiling mounting option.	<b>2FTX2FT</b> - 2' X 2'	<b>ULO</b> <sup>3</sup> - Uniform Lambertian Optic <b>ATR</b> <sup>4</sup> - Acrylic lens with tamper-resistant screws <b>PTR</b> - Polycarbonate lens with tamper-resistant screws  <sup>3</sup> Not available with Pop Seal model (POSEALSQR). <sup>4</sup> Only available with Pop Seal model (POSEALSQR).	<b>FH</b> - Flush <b>1D</b> <sup>5</sup> - 1" Drop <b>2D</b> <sup>5</sup> - 2" Drop <b>3D</b> <sup>5</sup> - 3" Drop <b>4D</b> <sup>5</sup> - 4" Drop  <sup>5</sup> Only available with ULO.	<b>SOLA</b> - Dim-to-warm single channel control 35K to 22K <b>DUO</b> - Tunable white 2-channel control 27K to 65K	<b>80</b> - 80CRI <b>90</b> - 90CRI	<b>2500</b> - Min. low output 2500lm <b>3500</b> - Medium output 3500lm <b>4500</b> - Max. high output 4500lm <b>####</b> - Other required lm

VOLTAGE	DRIVER <sup>6</sup>	ELECTRICAL	MOUNTING	FINISH	OPTIONS
		<b>1</b>			
<b>120</b> - 120V <b>277</b> - 277V	<b>DMX</b> <sup>7</sup> - To specify see pages 5 to 10 <b>DA</b> <sup>7</sup> - DALI (duo only) local on-site commissioning is required <b>0-10</b> - Single 0-10V input (Sola) or dual 0-10V input for CCT/Intensity (Duo) <b>PSQO</b> <sup>7</sup> - Lutron T-Series 1% Tunable White (Duo only)  <sup>6</sup> PoE (Power-over-Ethernet) compatible. Consult factory for details. <sup>7</sup> On-site commissioning is required.	<b>1</b> - 1 circuit	<b>TG9</b> - Tegular 9/16" <b>TG15</b> - Tegular 15/16" <b>TB9</b> - T-Bar 9/16" <b>TB15</b> - T-Bar 15/16" <b>ST</b> - Screw slot t-bar <b>DF</b> - Drywall kit	<b>W</b> - Matte white <b>WA</b> - White antimicrobial Silverwerx	<b>FU120</b> - Fuse 120V <b>FU277</b> - Fuse 277V <b>CP</b> - Chicago Plenum <b>NA</b> - None

### CROSS SECTION

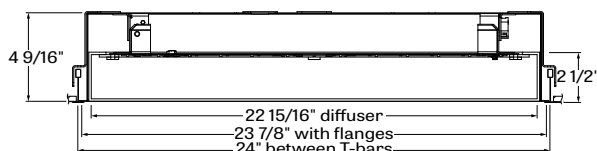

**POSQR + FH** - pop square recessed with flush lens

3737 Cote Vertu St-Laurent, Quebec, Canada H4R 2C9  
 T (514) 225-4304 F (514) 931-4862  
[www.lumenwerx.com](http://www.lumenwerx.com)



Lumenwerx reserves the right to modify product specifications without notification.  
 © Lumenwerx, ULC. All rights reserved.



POPRESSED-22-TW-SQUARE-RECESSED-SPEC-REV3.5 - February 10, 2026

**DMX WALL CONTROLS**

To specify see pages 5 to 10

# POP RECESSED

SQUARE 2X2

CHROMAWERX SOLA AND DUO



## Photometrics

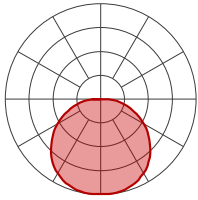

2500 LUMEN AT 80 CRI - LOW OUTPUT

LED OUTPUT	COLOR TEMP	WATTS	NOMINAL DELIVERED LUMENS	EFFICACY LPW
Low output	2700K	25	2500	101
Low output	3000K	24.5	2500	103
Low output	3500K	23.5	2500	106
Low output	4000K	22.5	2500	110

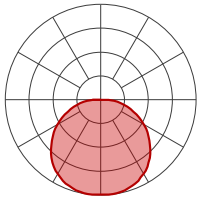

3500 LUMEN AT 80 CRI - MEDIUM OUTPUT

LED OUTPUT	COLOR TEMP	WATTS	NOMINAL DELIVERED LUMENS	EFFICACY LPW
Medium output	2700K	35.5	3500	98
Medium output	3000K	35	3500	100
Medium output	3500K	33.5	3500	104
Medium output	4000K	32.5	3500	107

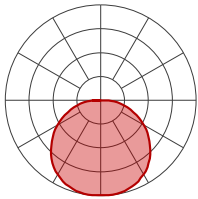

4500 LUMEN AT 80 CRI - HIGH OUTPUT

LED OUTPUT	COLOR TEMP	WATTS	NOMINAL DELIVERED LUMENS	EFFICACY LPW
High output	2700K	47	4500	96
High output	3000K	46	4500	98
High output	3500K	44.5	4500	101
High output	4000K	43.5	4500	104

# POP RECESSED

SQUARE 2X2

CHROMAWERX SOLA AND DUO



## Technical Specifications

### OPTICS

**UNIFORM EFFICIENCY LAMBERTIAN OPTIC (ULO)** - made of formed impact modified white PMMA, the optic provides an even light distribution with up to 88% transmission. Its unique enclosed shell design protects LEDs against Electrostatic Discharge and dust while its back surface project a soft glow on the mounting surface.

### DROP LENS

Pop square 22 recessed is available in 5 lens configurations.

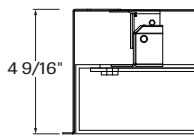

**POSQR + FH** -  
flush lens

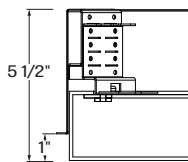

**POSQR + 1D** -  
1" drop lens

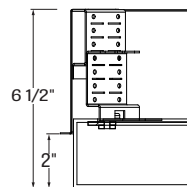

**POSQR + 2D** -  
2" drop lens

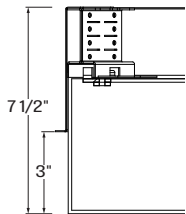

**POSQR + 3D** -  
3" drop lens

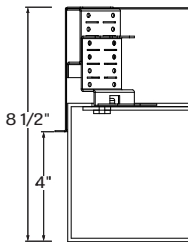

**POSQR + 4D** -  
4" drop lens

### LIGHT SOURCE

Custom array of alternating color temperature mid-flux LEDs are mounted directly to the housing for optimal thermal performance. For the Duo products, a color temperature range from 2700K-6500K is achievable with color points on or below the black body curve. For the Sola products, a color temperature range from 3500K-2200K is controlled synchronously with intensity. Color consistency between fixtures is maintained to within 3SDCM. LEDs are operated at reduced drive current to optimize efficacy and lumen maintenance.

All LEDs have been tested in accordance with IESNA LM-80-08 and the results have shown L80 lumen maintenance greater than 60,000 hours. Absolute product photometry is measured and presented in accordance with IESNA LM-79, unless otherwise indicated.

### CHROMAWERX - TUNABLE WHITE

#### ANSI C78.377-2015

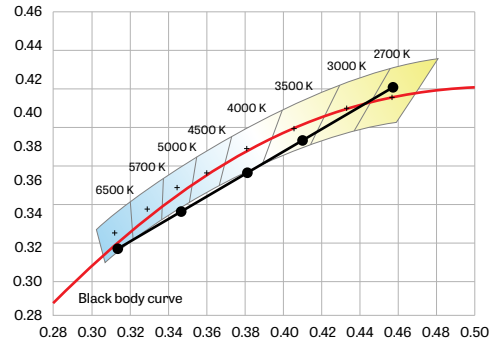

**Chromawerx Sola** is single-channel control that dims output while warming the color temperature in a pre-determined relationship. A simple digital or analog control sends a common signal to dual output digital drivers, which are programmed to adjust a specially populated LED array to emulate the effect of dimming a filament source. Dimming range is programmable but the default option runs from 3500K at 100% of full power to 2200K at 5% of full power. CRI is maintained above 80 throughout the dimming range.

**Chromawerx Duo** is two-channel control. It uses an analog (0-10V) protocol for separate control of luminaire CCT and intensity or a digital (DMX, DALI) protocol for synchronous control of both warm and cool LED arrays to enable the user to set color temperature and light output. Commonly called "tunable white", Chromawerx two-channel control provides the range of warm (2700K) to cool (6500K) color that can be useful for helping to entrain circadian rhythms, stimulate alertness for improved educational and work productivity, and compensate for jet lag, among other applications. The Chromawerx drivers are programmed to limit maximum light output and power usage across all color temperatures. CRI is maintained above 80.

### ELECTRICAL

#### DMX (Duo only)

Factory-Set adjustable output current electronic driver with 120-277V AC line input. Using DMX wall controls (optionally supplied by Lumenwerx) or an existing DMX control system, both channels of LEDs are independently adjustable. Each DMX driver can be independently addressed using the built-in RDM (Remote Device Management) in the field. Dimming down to 1% is attainable. Rated life (90% survivorship) of 50,000 hours at 50°C maximum ambient temperature. At maximum driver load, efficiency < 84%, PF > 0.9, THD < 20%.

# POP RECESSED

SQUARE 2X2

CHROMAWERX SOLA AND DUO



## DALI (Duo Only)

Factory-Set adjustable output current electronic driver with 120-277V AC line input. Using an existing DALI control system (supplied by others), one control channel adjusts the fixture color temperature, and the other control channel adjusts fixture brightness. Dimming down to 1% is attainable. Rated life (90% survivorship) of 50,000 hours at 50°C maximum ambient temperature. At maximum driver load, efficiency <84%, PF >0.9, THD <20%.

## 0-10V (Sola)

Factory-set, adjustable output current LED driver with universal (120-277VAC) input. Using a single 0-10V control signal, the light output warms in color temperature as it dims down to 1% and 2200K. At maximum driver load, efficiency <86%, PF >0.9, THD <20%.

## 0-10V (Duo)

Factory-set adjustable output current LED driver with universal (120-277VAC) input. Controlled via two individual 0-10V signals, one for setting light output down to a minimum of 1% and the other for adjusting the CCT (default range of 2700K-6500K). Rated life of 50,000 hours at 70°C maximum driver case temperature and 100% load conditions. Typical efficiency of 86%, PF >0.9, THD <20% at 100% load conditions.

## PSQ0 (Duo only)

Lutron T-Series 2-Channel tunable white drivers enable high-performance human centric lighting (HCL) applications. Digital control of color temperature (CCT) and intensity are achieved when used with the ESN T-Series tunable white controller as a part of a Lutron Quantum System.

## PoE

Depending on the PoE manufacturer selected, Lumenwerx will install the node in factory as either integral to the luminaire or as a remote module. Factory programming of the PoE node may or may not enable the following functionalities: lumen package, Duo (tunable white), emergency battery backup, and sensor integration. These must be addressed and evaluated on a case-by-case basis.

## MOUNTING OPTIONS

Recess mount into exposed or concealed T-Bar or Tegular grid ceiling. A separate kit for mounting fixtures into drywall ceilings.

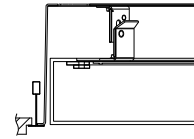

TG9 - tegular 9/16"

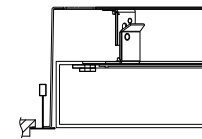

TG15 - tegular 15/16"

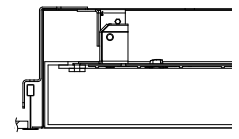

TB9 - t-bar 9/16"

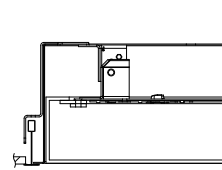

TB15 - t-bar 15/16"

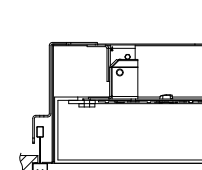

ST - screw slot t-bar

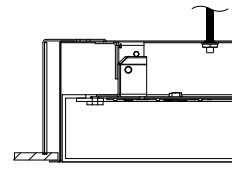

DF - drywall kit

## FINISH

**Interior** - 95% reflective, matte white powder coating

**Exterior** - matte white powder coating. Optional antimicrobial finish

## POP SEAL OPTION

The lens is gasketed and sealed, making the fixture suitable for healthcare applications. IP54 rated when specified with the drywall ceiling mounting option.

## CONSTRUCTION

**Housing** - 16 gauge spun aluminum, matte white powder coating

**Diffuser** - Uniform Lambertian optic, thermoformed impact modified acrylic, completely enclosed

**Gasket (Pop Seal)** - Closed-cell silicone foam gasket

## WEIGHT

**SQ 22 Flush, 1D, 2D** - 23.74lbs - 10.78kg

**SQ 22 3D, 4D** - 24.94lbs - 11.33kg

## CERTIFICATIONS

**ETL** - Rated for Indoor Dry/Damp locations. Conforms to UL Standard 1598 and certified to CAN/CSA Standard C22.2 No. 250.0.

**Chicago plenum** - City of Chicago Approved (CCEA)

**IC rated** - suitable for direct contact with insulation.

**NSF** - NSF2 Listed for Non-Food Zones.

## WARRANTY

Lumenwerx provides a five-year limited warranty of electrical and mechanical performance of the luminaires, including the LED boards, drivers, and auxiliary electronics. Lumenwerx will repair or replace defective luminaires or components at our discretion, provided they have been installed and operated in accordance with our specifications. Other limitations apply, please refer to the full warranty on our website.

Wall controllers are covered by the manufacturer warranty.

# POP RECESSED

SQUARE 2X2

CHROMAWERX SOLA AND DUO



## DUO DMX SPECIFICATION

A qualified DMX integrator is required to assure proper installation and commissioning of the DMX network. **When placing the PO, please provide the contact information of your DMX integrator.**

Please answer the following questions to help us identify your DMX network requirements.

YES

Do you require a wall controller provided by Lumenwerx?

NO

DMX control system supplied by others. Lumenwerx will supply DMX-enabled fixtures with default DMX addressing. See following pages for technical DMX informations. ✓

DMX controller supplied by Lumenwerx

**How many zones do you have?**

A zone consists of one or more luminaires behaving identically.

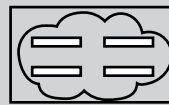

1 Zone



2 Zones

**How to calculate the required number of drivers:**

per 4' fixture

**Driver**

1x driver

Direct only

per 4' fixture

**Driver**

**Driver**

2x driver

Direct high output

To Calculate # of drivers

1 - 4 Zones

5 or more Zones

Do you have more than 32 drivers in total?

NO

YES

Order a standard Lumenwerx wall controller.

### WALL CONTROLLER

**WCW** - wall controller white

**WCB** - wall controller black

Add the control code at the end of your order code.

Please provide a fixture layout or RCP (Reflected Ceiling Plan) showing the locations of the DMX fixtures, zones and the DMX wall controller.

Refer to your DMX integrator for the installation. ✓

Subject to factory evaluation. Please contact our controls specialist at [controls@lumenwerx.com](mailto:controls@lumenwerx.com). Additional cost and equipment will be required. ✓

Subject to factory evaluation and approval. Please contact our controls specialist at [controls@lumenwerx.com](mailto:controls@lumenwerx.com). Additional cost and equipment will be required. ✓

# POP RECESSED

SQUARE 2X2

CHROMAWERX SOLA AND DUO



## GENERIC DMX NETWORK ARCHITECTURE

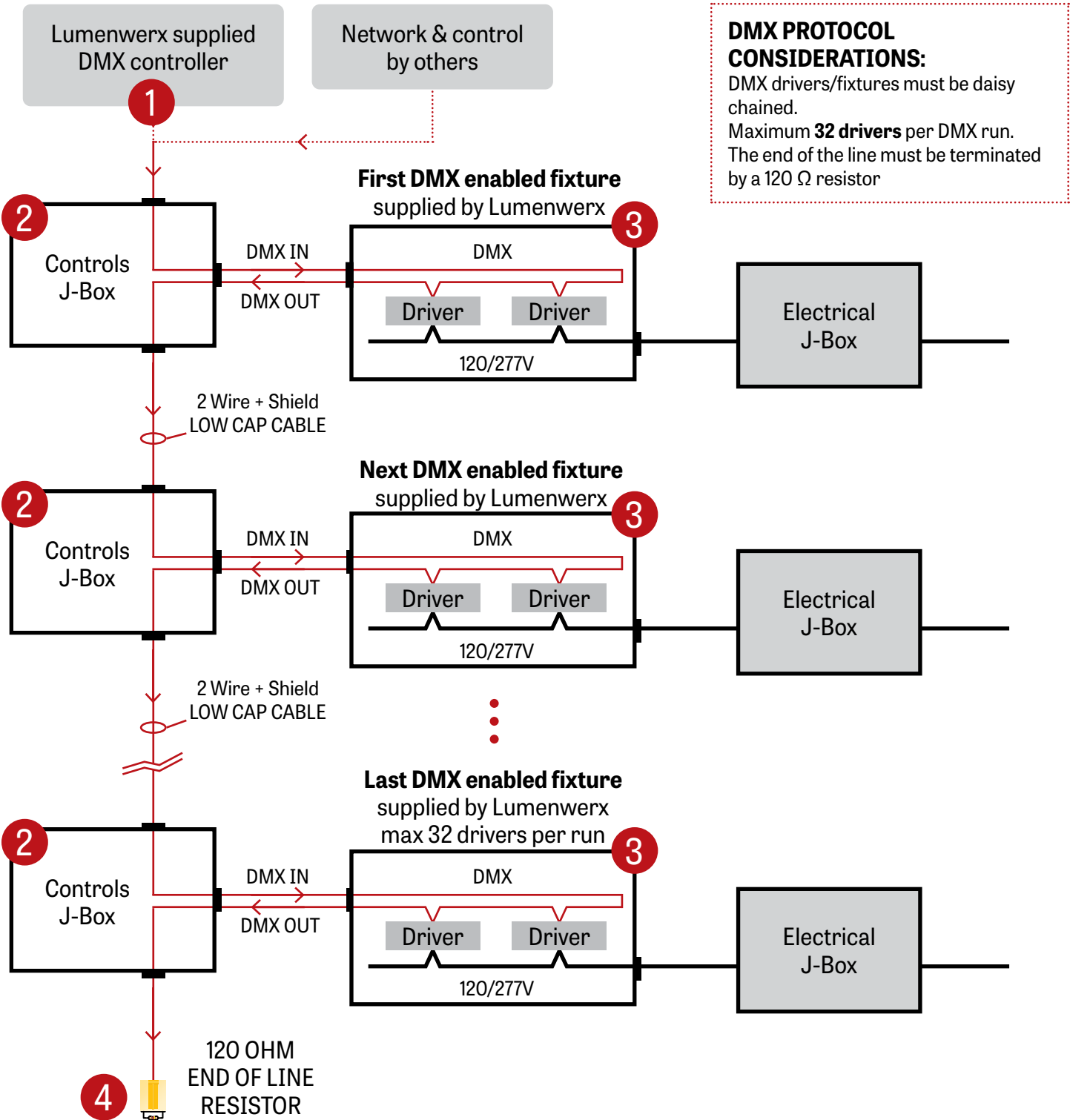

# POP RECESSED

SQUARE 2X2

CHROMAWERX SOLA AND DUO



## 1 LUMENWERX SUPPLIED DMX CONTROLLER

To the first fixture

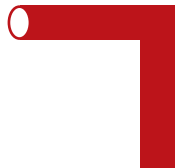

2 Wire +  
Shield Low Cap Cable

WALL BOX SUPPLIED BY OTHERS

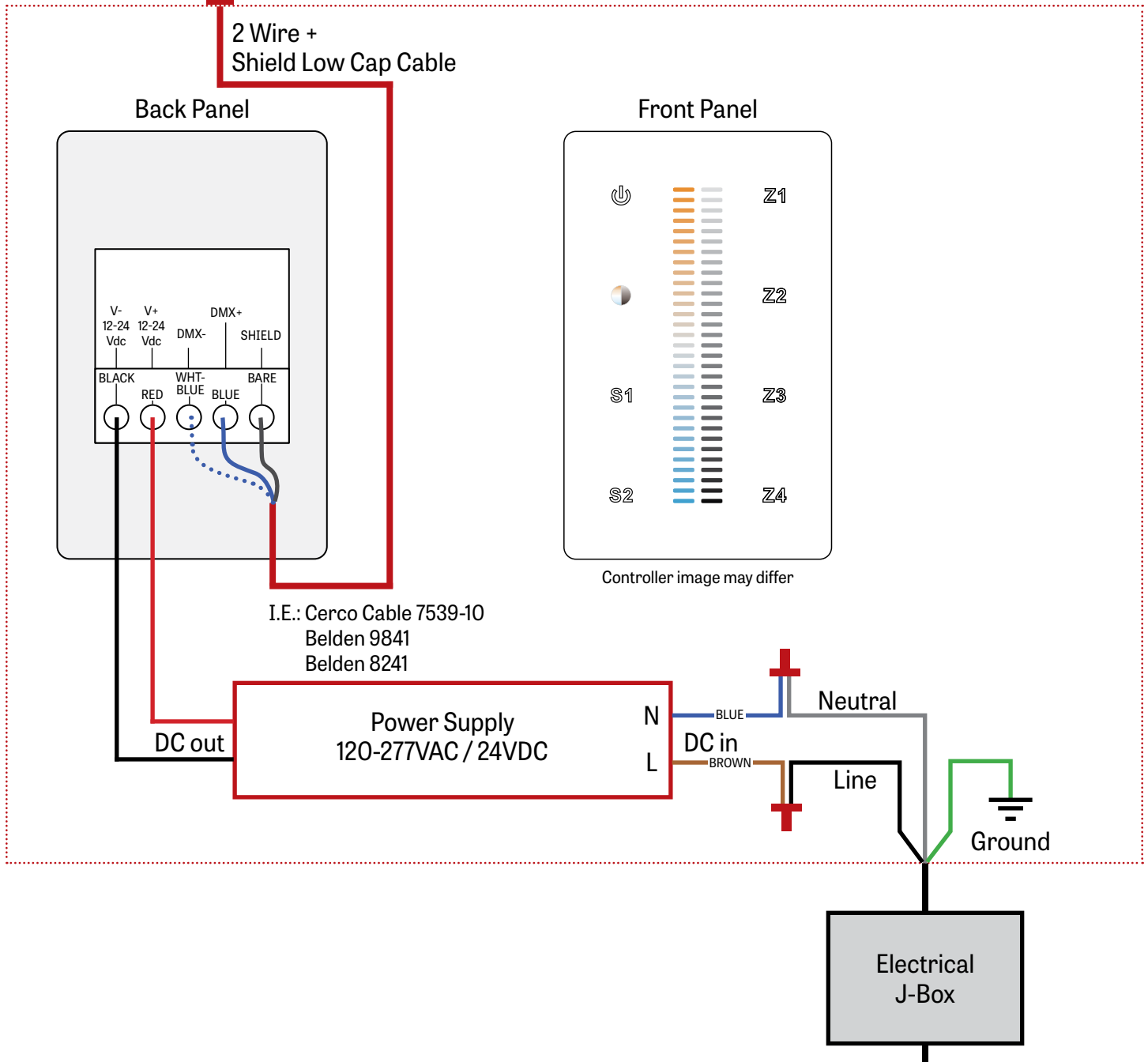

# POP RECESSED

SQUARE 2X2

CHROMAWERX SOLA AND DUO



## 2 J-BOX DMX DAISY CHAIN DETAIL

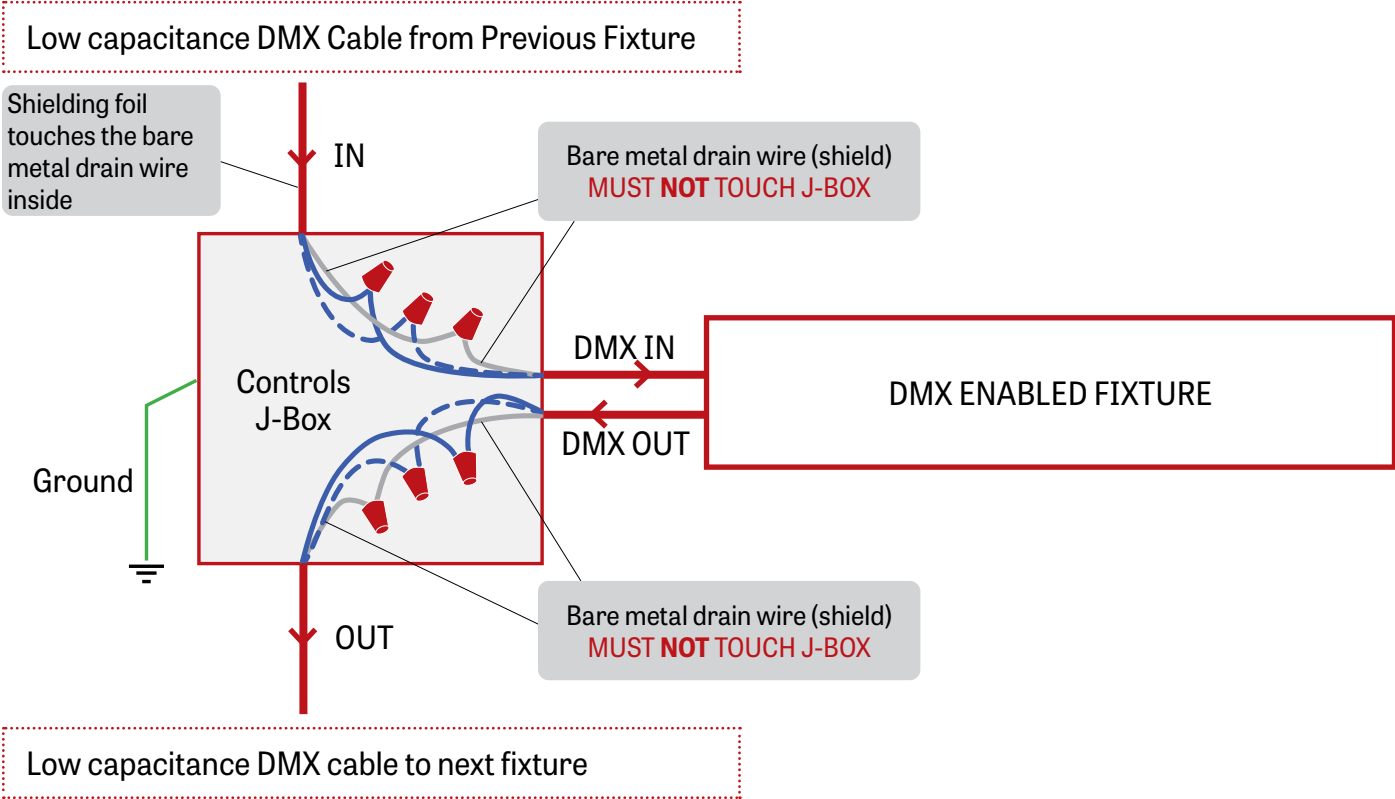

## 3 DMX CONNECTION RECESSED & SURFACE

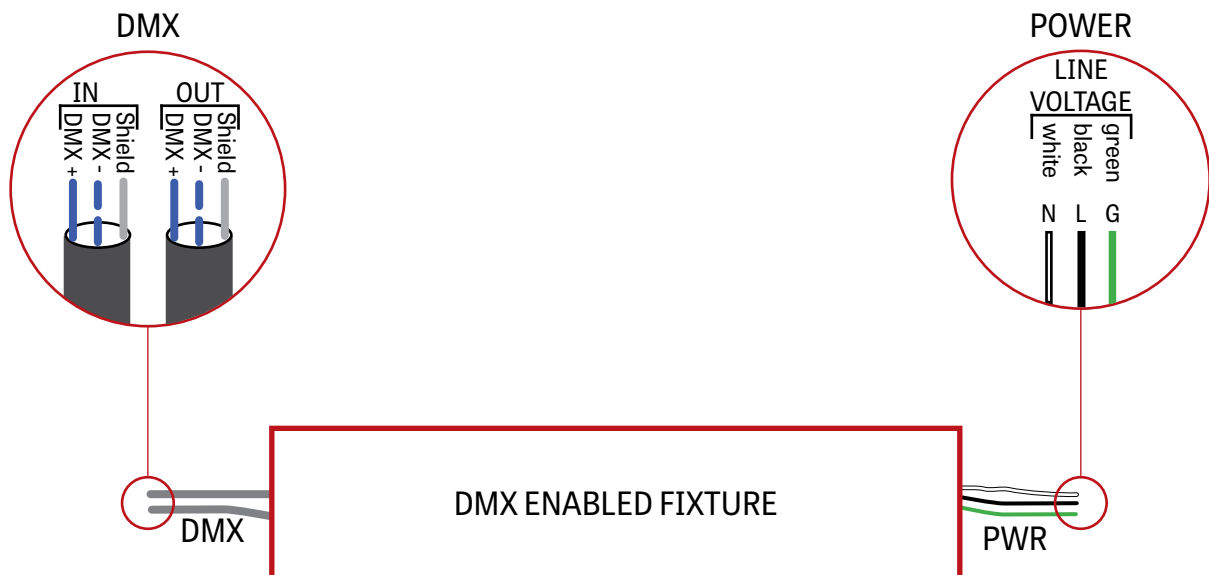

# POP RECESSED

SQUARE 2X2

CHROMAWERX SOLA AND DUO



## 4 DMX LAST FIXTURE DETAIL

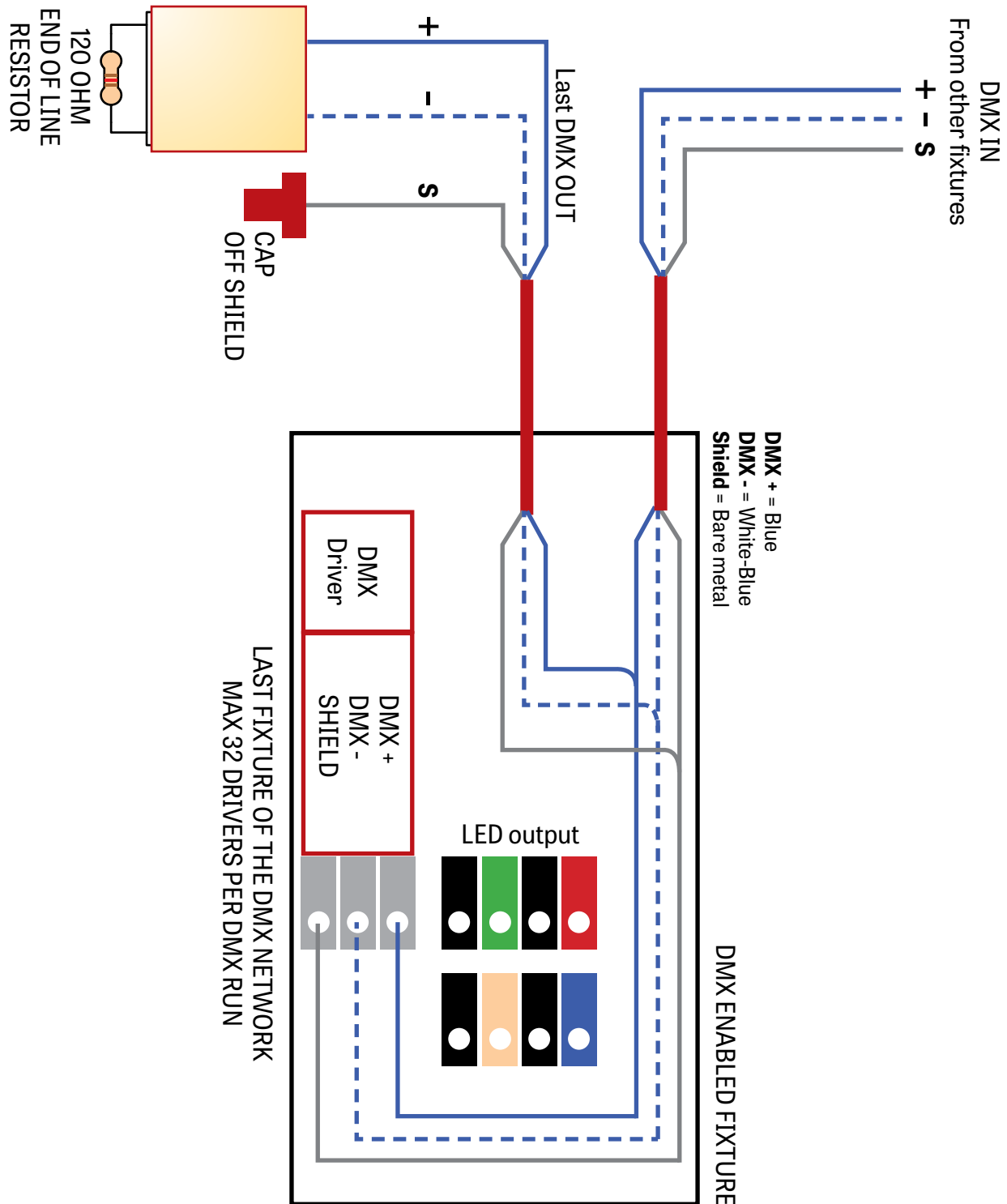

# POP RECESSED

SQUARE 2X2

CHROMAWERX SOLA AND DUO



## DMX WALL CONTROLLER

### DUO 1-4 ZONE

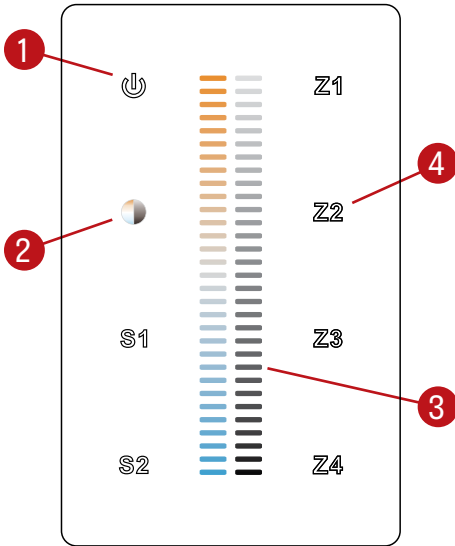

- (1) Power: Use this button to turn ON or OFF the fixture.
- (2) Brightness/CCT: Use the color/brightness toggle button to choose between color/brightness. When Blue: brightness is selected, when Yellow: color is selected.
- (3) Slider: Depending on the mode chosen in step 2, the slider will allow the user to set desired color or brightness.
- (4) Zone select: Up to 4 zones can be selected either independently or together. Once selected, the commands will be sent to the zone identified by a Blue LED.

### Default DMX Addresses:

- 1 Warm
- 2 Cool