

# PRIMO 2x2 LED

RECESSED



**LUMENWERX**  
WWW.LUMENWERX.COM

## CHROMAWERX TUNABLE WHITE AND DIM TO WARM

**IMPORTANT: a qualified DMX integration consultant is required to ensure proper installation and function of any DMX network**

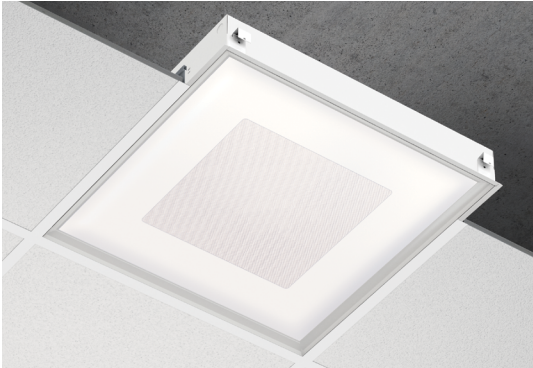

Shown with CMO Square optics

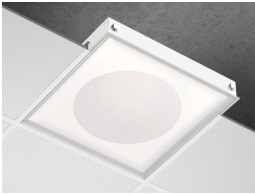

Shown with CMO Round optics

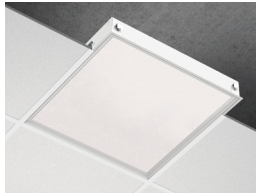

Shown with PMO optics

### DESCRIPTION

**Primo** is the fresh face of recessed LED lighting. The unique concentric micro optic creates a subtle, yet distinctive, graphical appearance appropriate for important spaces, large and small. The precise, square-base-prism design achieves both luminous consistency and overall visual comfort from all viewing angles. Using advanced LED engines and optics, Primo provides comfortable and efficient illumination where it's needed, while integrating cleanly into the architecture. Primo is an ideal vehicle for ChromaWerx white tuning in education, office, and healthcare applications where modular luminaires are used. See separate spec sheets for other available mountings.

**PROJECT:** \_\_\_\_\_  
 \_\_\_\_\_  
 \_\_\_\_\_  
**APPROVED BY:** \_\_\_\_\_  
**SIGNATURE:** \_\_\_\_\_

**up to 104 lm/w performance**

**IC RATED**

PRIR	22			LED			
LUMINAIRE ID	SIZE	OPTICS	LIGHT SOURCE	CRI	LUMEN PACKAGES	CHROMAWERX	
PRIR - primo recessed	22 - 2'x2'	<b>CMO(S)</b> - Concentric Micro-Prism Optic - square <b>CMO(R)</b> - Concentric Micro-Prism Optic - round <b>PMO</b> - Precision Micro-Prism Optic	<b>LED</b> - high performance LED	<b>80</b> - 80CRI <b>90</b> - 90CRI	<b>2000</b> - min. low output 2000lm <b>3200</b> - medium output 3200lm <b>4200</b> - high output 4200lm <b>5000</b> - max. ultra high output 5000lm ##### - other required lm	<b>DUO</b> - tunable white 2 channel control 27k to 65k <b>SOLA</b> - dim to warm single channel control 22k to 35k	
		<b>1</b>		<b>W</b>			
VOLTAGE	DRIVER	ELECTRICAL	MOUNTING	FINISH	OPTIONS	DMX WALL CONTROLS	
120 - 120V 277 - 277V	<b>DMX</b> - to specify see pages 5 to 10 <b>DA</b> - Dali (duo only) local on-site commissioning is required <b>O-10</b> - Single 0-10V input (Sola) or dual 0-10V input for CCT/Intensity (Duo) <b>PSQO</b> - Lutron T-Series 1% Tunable White	1 - 1 circuit	<b>TG9</b> - tegular 9/16" <b>TG15</b> - tegular 15/16" <b>TB9</b> - t-bar 9/16" <b>TB15</b> - t-bar 15/16" <b>ST</b> - screw slot t-bar <b>DF</b> - drywall kit	W - matte white	<b>FU120</b> - Fuse 120V <b>FU277</b> - Fuse 277V <b>FWC</b> - flexible whip cable (6' std) <b>CP</b> - Chicago Plenum <b>CU</b> - custom	To specify see pages 5 to 10	

See page 2 for ordering code detailed information

### CROSS SECTION

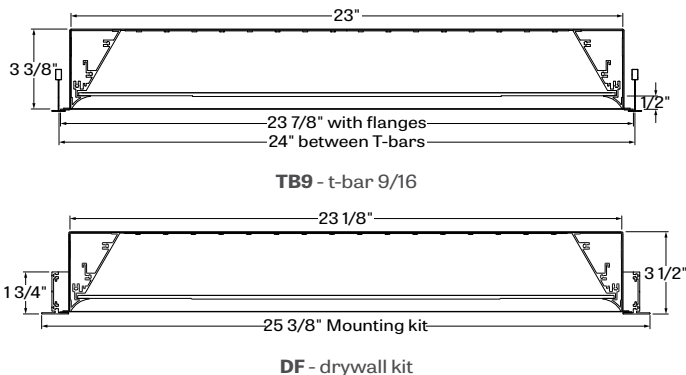

### ANSI C78.377-2015

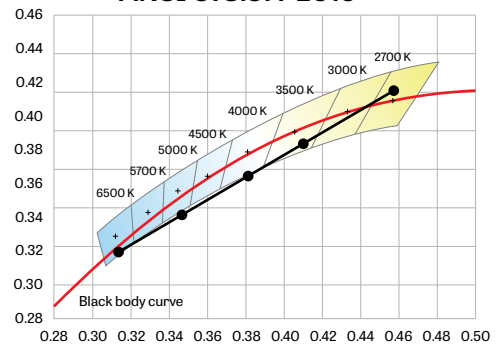

## CHROMAWERX TUNABLE WHITE AND DIM TO WARM

### OPTICS

**PRECISION MICRO-PRISM-OPTIC (PMO) / CONCENTRIC MICRO -OPTIC (CMO)** - utilizes a specially designed catadioptric lens that combines refraction and internal reflection. The square-base prism is 24% the size of those used in a high-performance fluorescent lens.

The acrylic material itself is untinted, relying entirely on catadioptric control for effective source obscuration. A highly efficient TIR process at the acrylic-air interface on the prism surfaces redirects incident light with less than a 0.1% loss per reflection. As a result, these LumenWerx optics attain a high optical efficiency greater than 90%, while maintaining visual comfort at normal viewing angles and presenting a pleasing luminous appearance.

**PRECISION MICRO-PRISM-OPTIC (PMO)** - The exclusive two-dimensional array of prisms is designed to eliminate the glare found at higher viewing angles and as such, enables a glare cut-off at a 45° viewing angle.

**CONCENTRIC MICRO-PRISM-OPTIC (CMO)** - With the smaller prisms of the outer optic giving way to the larger prisms found in the inner optic, the exclusive pyramidal forms provide an outstanding level of control over high angle brightness as well as a gentle brightness gradient from different viewing angles.

### LIGHT SOURCE - LED

LED output	Color Temp	Watts	Nominal Delivered Lumens	Efficacy LPW
low output	4000K	19	2000	104
medium output	4000K	32	3200	100
high output	4000K	43	4200	97
ultra high output	4000K	53	5000	95

#### Lumen Adjustment Factors

2700K	0.917
3000K	0.959
3500K	0.988
4000K	1.000
6500K	1.053

Custom array of alternating color temperature mid-flux LED's are mounted directly to the housing for optimal thermal performance. For the Duo products, a color temperature range from 2700K-6500K is achievable with color points on or below the black body curve. For the Sola products, a color temperature range from 2200K-3500K is controlled synchronously with intensity. Color consistency between fixtures is maintained to within 3SDCM. LEDs are operated at reduced drive current to optimize efficacy and lumen maintenance.

All LED's have been tested in accordance with IESNA LM-80-08 and the results have shown L80 lumen maintenance greater than 60,000 hours. Absolute product photometry is measured and presented in accordance with IESNA LM-79, unless otherwise indicated.

### CHROMAWERX - TUNABLE WHITE

#### ANSI C78.377-2015

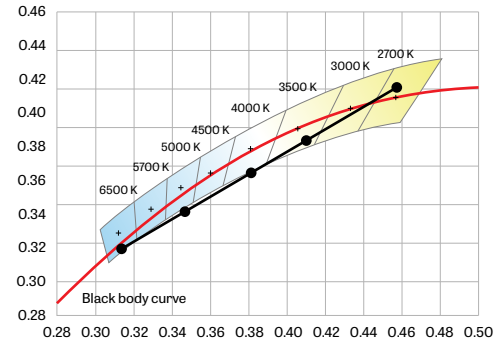

**ChromaWerx Sola** is single-channel control that dims output while warming the color temperature in a pre-determined relationship. A simple digital or analog control sends a common signal to dual output digital drivers, which are programmed to adjust a specially populated LED array to emulate the effect of dimming a filament source. Dimming range is programmable but the default option runs from 3500K at 100% of full power to 2200K at 5% of full power. CRI is maintained above 80 throughout the dimming range.

**ChromaWerx Duo** is two-channel control. It uses an analog (0-10V) protocol for separate control of luminaire CCT and intensity or a digital (DMX, DALI) protocol for synchronous control of both warm and cool LED arrays to enable the user to set color temperature and light output. Commonly called "tunable white", ChromaWerx two-channel control provides the range of warm (2700K) to cool (6500K) color that can be useful for helping to entrain circadian rhythms, stimulate alertness for improved educational and work productivity, and compensate for jet lag, among other applications. The ChromaWerx drivers are programmed to limit maximum light output and power usage across all color temperatures. CRI is maintained above 80.

# PRIMO 2x2 LED

RECESSED

LUMENWERX  
WWW.LUMENWERX.COM

## CHROMAWERX TUNABLE WHITE AND DIM TO WARM

### ELECTRICAL

#### DMX (Duo only)

Factory-set, adjustable output current, multi-channel LED driver with universal (120-277VAC) input. Using DMX wall controls (optionally supplied by LumenWerx) or an existing DMX control system, two channels of LEDs (warm-white & cool-white) are independently adjustable. Each DMX driver has multiple output channels that can be independently addressed at the factory or on-site using built-in RDM (Remote Device Management) functionality. Dimming range from 100%-0%. At maximum driver load, efficiency<89%, PF>0.9, THD<20%.

#### Dali (Duo Only)

Factory-set, adjustable output current LED driver with universal (120-277VAC) input. Using an existing DALI control system (supplied by others), one control channel adjusts the fixture color temperature, and the other control channel adjusts fixture brightness. Dimming range from 100%-0%. At maximum driver load, efficiency<86%, PF>0.9, THD<20%.

#### 0-10V (Sola)

Factory-set, adjustable output current LED driver with universal (120-277VAC) input. Using a single 0-10V control signal, the light output warms in color temperature as it dims down to 1% and 2200K. At maximum driver load, efficiency<86%, PF>0.9, THD<20%.

#### 0-10V (Duo)

Factory-set adjustable output current LED driver with universal (120-277VAC) input. Controlled via two individual 0-10V signals, one for setting light output down to a minimum of 1% and the other for adjusting the CCT (default range of 2700K-6500K). Rated life of 50,000 hours at 70°C maximum driver case temperature and 100% load conditions. Typical efficiency of 86%, PF>0.9, THD<20% at 100% load conditions.

### MOUNTING OPTIONS

Recess mount into exposed or concealed T-Bar or Tegular grid ceiling

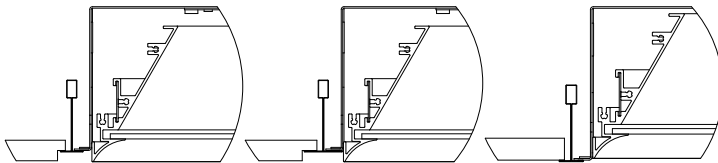

TG9 - tegular 9/16"

TG15 - tegular 15/16"

TB9 - t-bar 9/16"

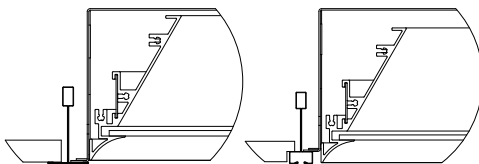

TB15 - t-bar 15/16"

ST - screw slot t-bar

A separate kit for mounting fixtures into drywall ceilings

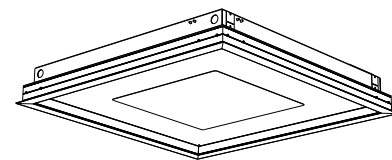
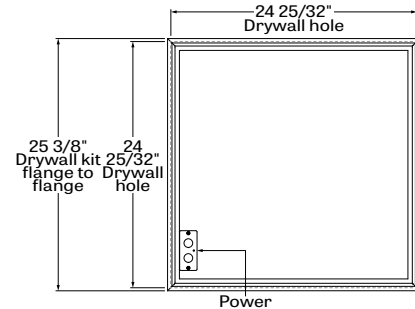

DF - drywall kit

### FINISH

**Interior** - 95% reflective, matte white powder coating

**Exterior** - matte white powder coating.

### CONSTRUCTION

**Housing** - Die formed cold rolled sheet steel 20 gauge thick, matte white powder coating.

**Reflectors** - Extruded Aluminum 0.07" nominal, integrated into a door system, 95% reflective matte white painted.

**Door system** - integrated frame with no visible attachment, made of extruded Aluminum and lens made in clear PMMA precisely molded into optical prismatic forms offered in different patterns.

**Drywall kit** - Extruded Aluminum 0.07" nominal, matte white powder coating.

### WEIGHT

**Primo 2x2 grid**: 17.84lbs. - 8.1kg

**Primo 2x2 drywall**: 19.94lbs. - 9.24kg

### CERTIFICATIONS

**ETL** - Rated for Indoor Dry/Damp locations.

Conforms to UL Standard 1598 and certified to CAN/CSA Standard C22.2 No. 250.0.

**Chicago plenum** - City of Chicago Approved (CCEA)

**IC rated** - suitable for direct contact with insulation.

# PRIMO 2x2 LED

RECESSED



## CHROMAWERX TUNABLE WHITE AND DIM TO WARM

### WARRANTY

For all ChromaWerx products, LumenWerx provides a three-year limited warranty of electrical and mechanical performance of the luminaires, including the LED boards, drivers, and auxiliary electronics. LumenWerx will repair or replace defective luminaires or components at our discretion, provided they have been installed and operated in accordance with our specifications. Other limitations apply, please refer to the full warranty on our website.

Wall controllers are covered by the manufacturer warranty.



# PRIMO 2x2 LED

RECESSED

## CHROMAWERX TUNABLE WHITE

### DUO DMX SPECIFICATION

A qualified DMX integrator is required to assure proper installation and commissioning of the DMX network. **When placing the PO, please provide the contact information of your DMX integrator.**

Please answer the following questions to help us identify your DMX network requirements.

YES

Do you require a wall controller provided by Lumenwerx?

NO

DMX control system supplied by others. Lumenwerx will supply DMX-enabled fixtures with default DMX addressing. See following pages for technical DMX informations. ✓

DMX controller supplied by Lumenwerx

**How many zones do you have?**

A zone consists of one or more luminaires behaving identically.

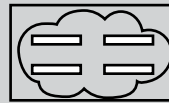

1 Zone



2 Zones

**How to calculate the required number of drivers:**

per 4' fixture

Driver

1x driver

Direct only

per 4' fixture

Driver Driver

2x driver

Direct high output

To Calculate # of drivers

1 - 4 Zones

5 or more Zones

Do you have more than 32 drivers in total?

NO

YES

Order a standard Lumenwerx wall controller.

#### WALL CONTROLLER

**WCW** - wall controller white  
**WCB** - wall controller black

Add the control code at the end of your order code.

Please provide a fixture layout or RCP (Reflected Ceiling Plan) showing the locations of the DMX fixtures, zones and the DMX wall controller.

Refer to your DMX integrator for the installation. ✓

Subject to factory evaluation. Please contact our controls specialist at [controls@lumenwerx.com](mailto:controls@lumenwerx.com). Additional cost and equipment will be required. ✓

Subject to factory evaluation and approval. Please contact our controls specialist at [controls@lumenwerx.com](mailto:controls@lumenwerx.com). Additional cost and equipment will be required. ✓

# PRIMO 2x2 LED

RECESSED

CHROMAWERX TUNABLE WHITE

## GENERIC DMX NETWORK ARCHITECTURE

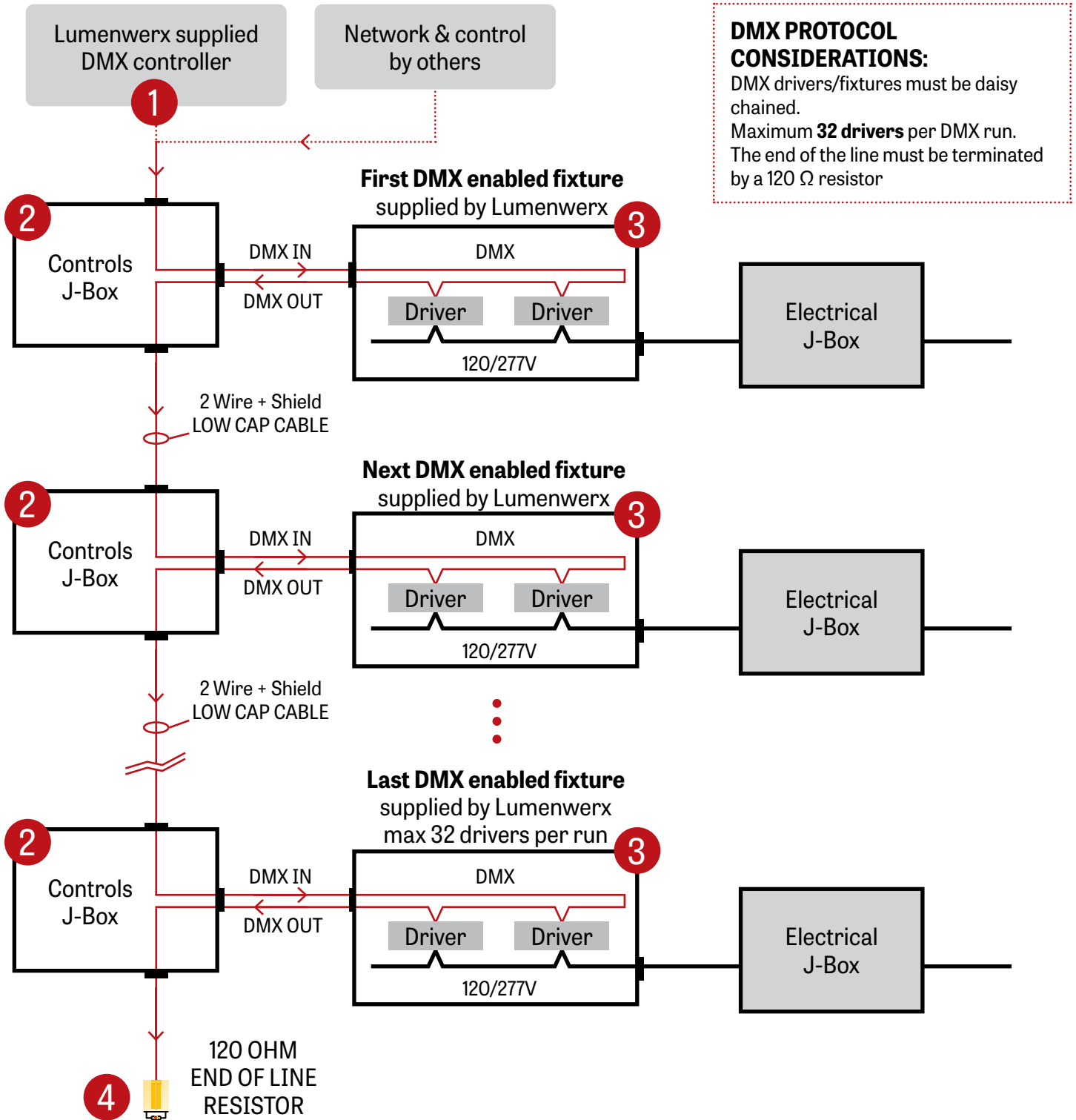

# PRIMO 2x2 LED

RECESSED

## CHROMAWERX TUNABLE WHITE

### 1 LUMENWERX SUPPLIED DMX CONTROLLER

To the first fixture

2 Wire +  
Shield Low Cap Cable

WALL BOX SUPPLIED BY OTHERS

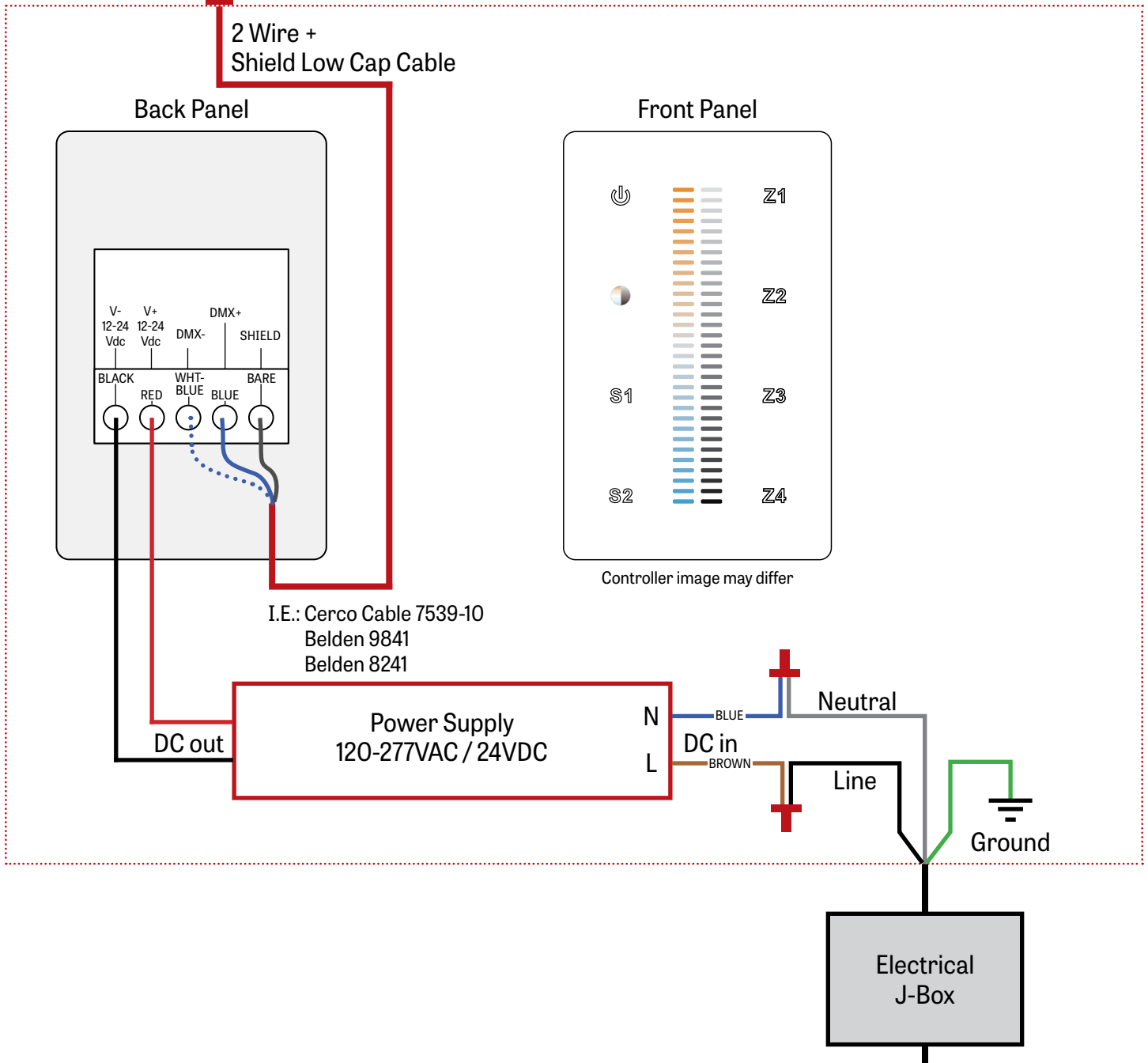

CHROMAWERX TUNABLE WHITE

2 J-BOX DMX DAISY CHAIN DETAIL

Low capacitance DMX Cable from Previous Fixture

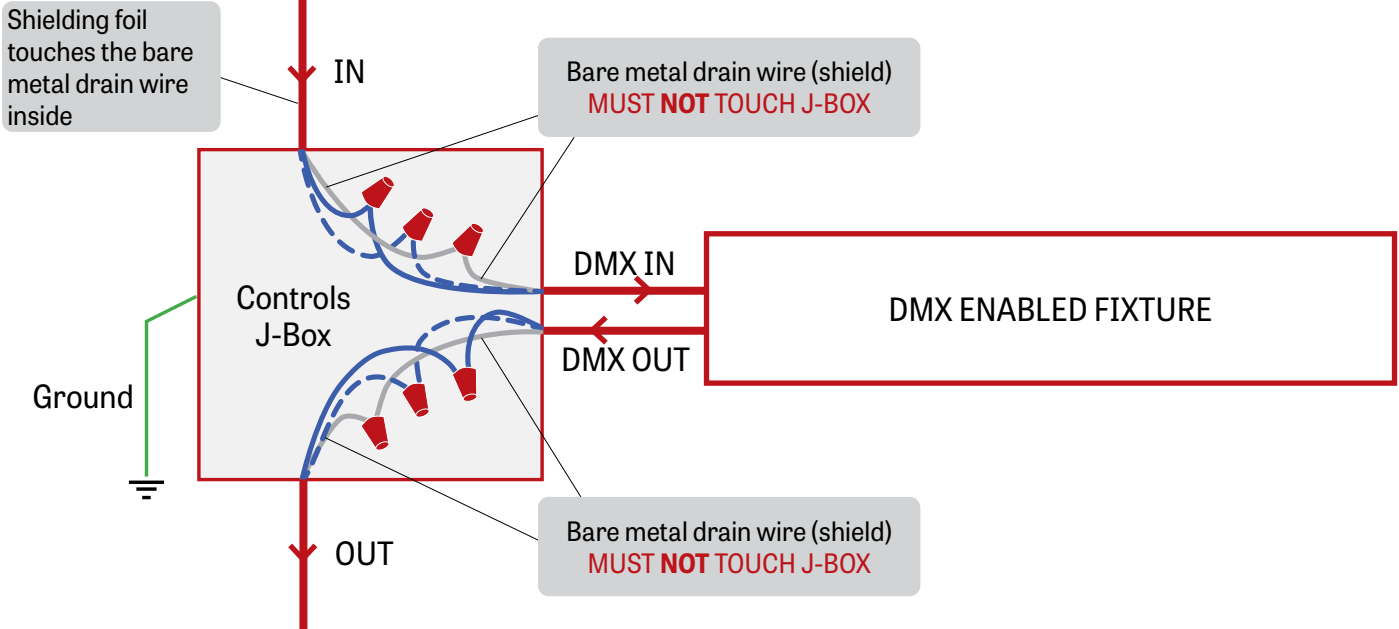

Low capacitance DMX cable to next fixture

3 DMX CONNECTION RECESSED & SURFACE

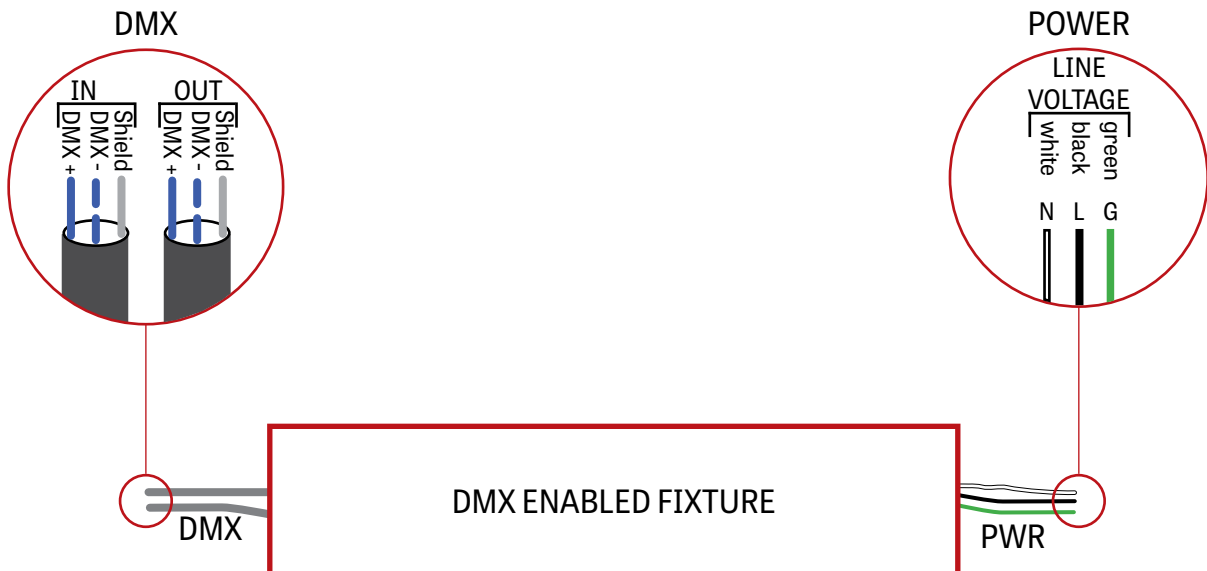



# PRIMO 2x2 LED

RECESSED

CHROMAWERX TUNABLE WHITE

DMX WALL CONTROLLER

## DUO 1-4 ZONE

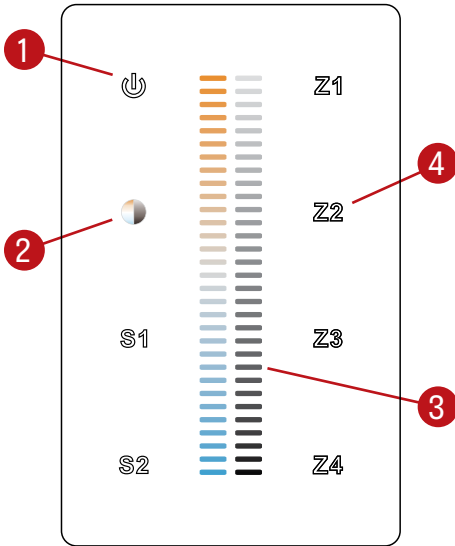

- (1) Power: Use this button to turn ON or OFF the fixture.
- (2) Brightness/CCT: Use the color/brightness toggle button to choose between color/brightness. When Blue: brightness is selected, when Yellow: color is selected.
- (3) Slider: Depending on the mode chosen in step 2, the slider will allow the user to set desired color or brightness.
- (4) Zone select: Up to 4 zones can be selected either independently or together. Once selected, the commands will be sent to the zone identified by a Blue LED.

### Default DMX Addresses:

- 1 Warm
- 2 Cool

# PRIMO 2x2 LED

RECESSED

## CHROMAWERX TUNABLE WHITE AND DIM TO WARM

### 2000 LUMEN AT 80CRI - LOW OUTPUT

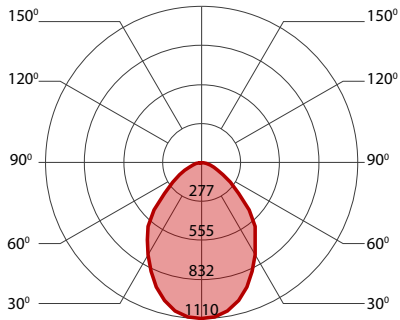

#### PERFORMANCE

LED output	Color Temp	Watts	Nominal Delivered Lumens	Efficacy LPW
low output	2700K	21	2000	96
low output	3000K	20	2000	98
low output	3500K	20	2000	101
low output	4000K	19	2000	104
low output	6500K	18.5	2000	108

### 3200 LUMEN AT 80CRI - MEDIUM OUTPUT

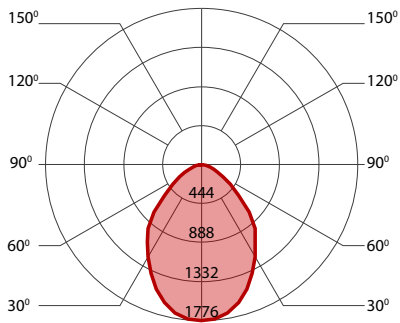

#### PERFORMANCE

LED output	Color Temp	Watts	Nominal Delivered Lumens	Efficacy LPW
medium output	2700K	35	3200	92
medium output	3000K	34	3200	94
medium output	3500K	33	3200	97
medium output	4000K	32	3200	100
medium output	6500K	31	3200	104

### 4200 LUMEN AT 80CRI - HIGH OUTPUT

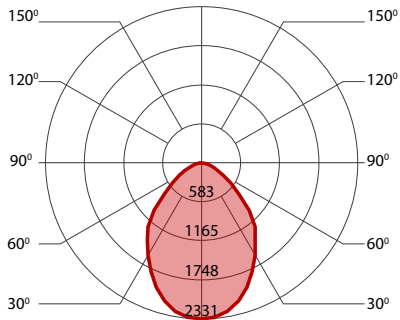

#### PERFORMANCE

LED output	Color Temp	Watts	Nominal Delivered Lumens	Efficacy LPW
high output	2700K	47	4200	89
high output	3000K	46	4200	91
high output	3500K	45	4200	94
high output	4000K	43	4200	97
high output	6500K	41.5	4200	101

### 5000 LUMEN AT 80CRI - ULTRA HIGH OUTPUT

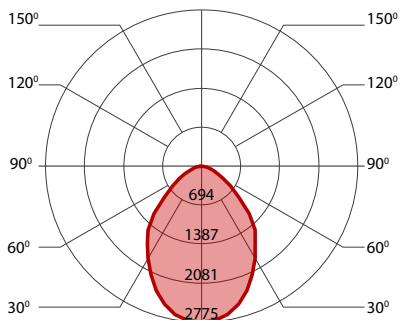

#### PERFORMANCE

LED output	Color Temp	Watts	Nominal Delivered Lumens	Efficacy LPW
ultra high output	2700K	57.5	5000	87
ultra high output	3000K	56	5000	89
ultra high output	3500K	54	5000	92
ultra high output	4000K	53	5000	95
ultra high output	6500K	50.5	5000	99