

RIM MINI ROUND

PENDANT
STATIC WHITE



Project: _____
Type: _____



DESCRIPTION

Rim Mini is part of our Miniwerx Collection—a growing series of luminaires engineered to deliver full-scale performance in significantly reduced form factors. At just 1.25" tall and 0.8" wide, Rim Mini is over 40% slimmer than the standard Rim profile and maintains the design freedom the Rim Collection is known for. It enables clean, precise lighting with a minimal visual footprint and maximum flexibility across shapes, sizes, and configuration options.

Order Guide

| LUMINAIRE ID | SIZE | OPTIC | LIGHT SOURCE ¹ | CRI | |
|---|--|---|---------------------------------------|--|------------------------|
| RIMMIRP | | ULO | SW | 90CRI | |
| RIMMIRP - Rim Mini Round Pendant | 12IN - Ø 12" 18IN - Ø 18" 24IN - Ø 24" 36IN - Ø 36" | 48IN - Ø 48" 60IN - Ø 60" 72IN - Ø 72" | ULO - Uniform Lambertian Optic | SW - Static white ¹ Chromawerx SOLA, DUO, and QUADRO also available. Consult factory. | 90CRI - 90+ CRI |

| LUMEN PACKAGE | COLOR TEMPERATURE | VOLTAGE | REMOTE DRIVER | ELECTRICAL ⁴ | | |
|---|--|---|--|---|--|--|
| | | | | 1C | | |
| Ø 12" 1000LM Ø 18" 1500LM Ø 24" 2000LM Ø 36" 3000LM Ø 48" 4000LM Ø 60" 5000LM Ø 72" 6000LM | Low 1000LM 1500LM 2000LM 3000LM 4000LM 5000LM 6000LM | High 1500LM 2200LM 3000LM 4500LM 6000LM 7500LM 9000LM | 27K - 2700K 30K - 3000K 35K - 3500K 40K - 4000K | 120V - 120V 277V - 277V UNV - 120V-277V 347V ² -347V ² Available with D1 driver only. | D1 - 1% 0-10V DA ³ - DALI LDE1 ³ - Lutron Hi-Lume 1% Eco ELD1 - eldoLED 1% ECOdrive 0-10V ELD0 - eldoLEDO,1% SOLOdrive 0-10V ³ On-site commissioning is required. | 1C - 1 circuit ⁴ For other circuit configurations, consult factory. |

| MOUNTING | | | | | FINISH | | | | | | | | | | | | | | | | |
|---|---|--|---|--|---|----------------|-------|----|-------|-----|-------|-----|-------|-----|-------|-----|-------|-----|-------|-----|--|
| DRIVER BOX ⁵ RCD ^{6,7} - Round canopy driver box RDB - Remote driver box ⁵ For more information see page 3. ⁶ With single canopy option, not available for lumen packages over 6000 lm (3500 lm for Lutron driver options). ⁷ Not available with 347V. | CANOPY FINISH W - Matte white AL - Aluminum B - Matte black CF - Custom finish, specify RAL# | POWER POC - Integrated suspension power-over-aircraft cable BAC - Black power cord + aircraft cable WAC - White power cord + aircraft cable | MOUNTING POINTS SC - Single canopy MC ^{8,9} - Multiple canopies ⁸ 4 Canopies provided. ⁹ With the RCD option, the type of each canopy may differ based on the selected lumen package and driver options. Consult factory for details. | MOUNTING CABLE LENGTH ¹⁰ 18IN - 18" 72IN - 72" 24IN - 24" 96IN - 96" 36IN - 36" 120IN - 120" 48IN - 48" ##IN - Specify nominal length in inches 60IN - 60" | W - Matte white AL - Aluminum B - Matte black CF - Custom finish, specify RAL# | | | | | | | | | | | | | | | | |
| ¹⁰ For single canopy option, the minimum required mounting heights are (distance from ceiling to top of fixture in inches): | | | | | | | | | | | | | | | | | | | | | |
| <table border="1"> <thead> <tr> <th>Fixture size</th> <th>Minimum height</th> </tr> </thead> <tbody> <tr><td>Ø 12"</td><td>8"</td></tr> <tr><td>Ø 18"</td><td>11"</td></tr> <tr><td>Ø 24"</td><td>15"</td></tr> <tr><td>Ø 36"</td><td>22"</td></tr> <tr><td>Ø 48"</td><td>29"</td></tr> <tr><td>Ø 60"</td><td>36"</td></tr> <tr><td>Ø 72"</td><td>43"</td></tr> </tbody> </table> | | | | | Fixture size | Minimum height | Ø 12" | 8" | Ø 18" | 11" | Ø 24" | 15" | Ø 36" | 22" | Ø 48" | 29" | Ø 60" | 36" | Ø 72" | 43" | |
| Fixture size | Minimum height | | | | | | | | | | | | | | | | | | | | |
| Ø 12" | 8" | | | | | | | | | | | | | | | | | | | | |
| Ø 18" | 11" | | | | | | | | | | | | | | | | | | | | |
| Ø 24" | 15" | | | | | | | | | | | | | | | | | | | | |
| Ø 36" | 22" | | | | | | | | | | | | | | | | | | | | |
| Ø 48" | 29" | | | | | | | | | | | | | | | | | | | | |
| Ø 60" | 36" | | | | | | | | | | | | | | | | | | | | |
| Ø 72" | 43" | | | | | | | | | | | | | | | | | | | | |

RIM MINI ROUND



PENDANT
STATIC WHITE

Dimensions

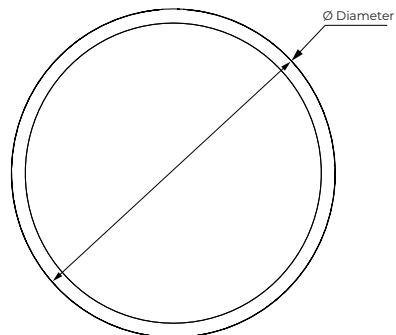

| Size | Ø Diameter |
|-------|------------|
| Ø 12" | Ø 12 5/8" |
| Ø 18" | Ø 18 5/8" |
| Ø 24" | Ø 24 5/8" |
| Ø 36" | Ø 36 5/8" |
| Ø 48" | Ø 48 5/8" |
| Ø 60" | Ø 60 5/8" |
| Ø 72" | Ø 72 5/8" |

SECTION VIEW

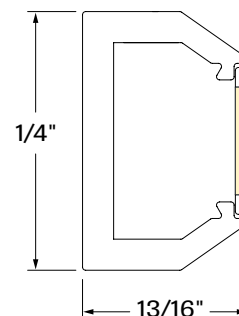

Photometrics

Delivered lumens at 4000K at 90+ CRI

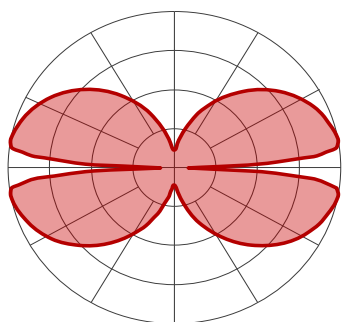

Ø 12"

| LM | WATTS | LM/W |
|------|-------|------|
| 1000 | 11.1 | 90 |
| 1500 | 17.2 | 87 |

Ø 18"

| LM | WATTS | LM/W |
|------|-------|------|
| 1500 | 16.7 | 90 |
| 2250 | 25.9 | 87 |

Ø 24"

| LM | WATTS | LM/W |
|------|-------|------|
| 2000 | 22.2 | 90 |
| 3000 | 34.6 | 87 |

Ø 36"

| LM | WATTS | LM/W |
|------|-------|------|
| 3000 | 33.4 | 90 |
| 4500 | 52 | 87 |

Ø 48"

| LM | WATTS | LM/W |
|------|-------|------|
| 4000 | 44.5 | 90 |
| 6000 | 69.2 | 87 |

Ø 60"

| LM | WATTS | LM/W |
|------|-------|------|
| 5000 | 55.6 | 90 |
| 7500 | 86.2 | 87 |

MULTIPLIER TABLE

Use this table to get results for different color temperatures and CRI for all photometric tables.

| CCT | WATTS | LPW |
|-------|-------|------|
| 2700K | 1.08 | 0.92 |
| 3000K | 1.05 | 0.96 |
| 3500K | 1.02 | 0.98 |
| 4000K | 1.00 | 1.00 |

Ø 72"

| LM | WATTS | LM/W |
|------|-------|------|
| 6000 | 66.7 | 90 |
| 9000 | 103.9 | 87 |

RIM MINI ROUND



PENDANT
STATIC WHITE

Mounting Options

RCD - ROUND CANOPY DRIVER BOX

SC - SINGLE CANOPY

MC - MULTIPLE CANOPY

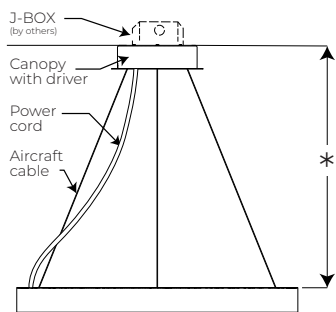

AC - Aircraft cable

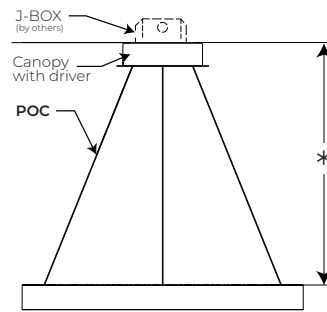

POC - Power-over-aircraft cable

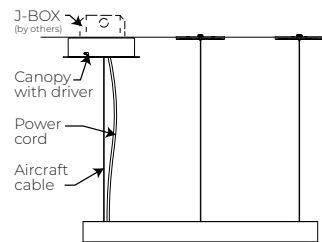

AC - Aircraft cable

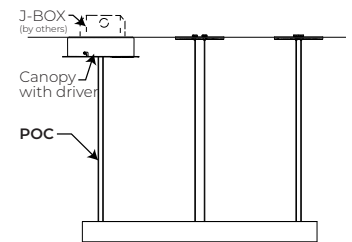

POC - Power-over-aircraft cable

RDB - REMOTE DRIVER BOX

SC - SINGLE CANOPY

MC - MULTIPLE CANOPY

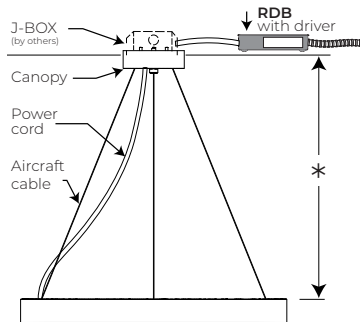

AC - Aircraft cable

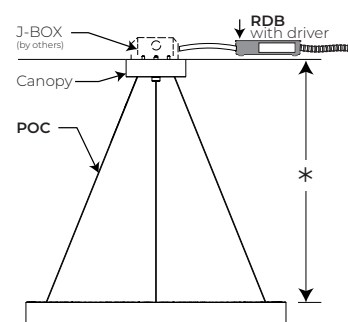

POC - Power-over-aircraft cable

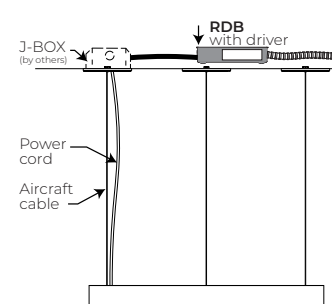

AC - Aircraft cable

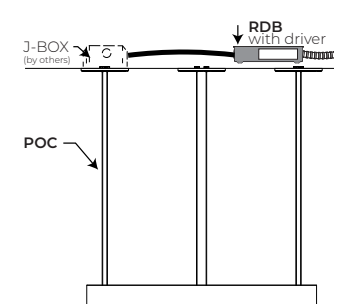

POC - Power-over-aircraft cable

*minimum height

For single canopy option, the minimum required mounting heights:

Fixture size * Minimum height

| Fixture size | * Minimum height |
|--------------|------------------|
| Ø 12" | 8" |
| Ø 18" | 11" |
| Ø 24" | 15" |
| Ø 36" | 22" |
| Ø 48" | 29" |
| Ø 60" | 36" |
| Ø 72" | 43" |

RIM MINI ROUND



PENDANT
STATIC WHITE

Technical Specifications

OPTIC

Uniform Lambertian Optic (ULO)

Thermoformed from impact-modified white PMMA, the ULO provides even luminosity, with up to 88% transmission. Combined with the LED array running around the inside of the housing, the open form and ULO create a widespread 50% direct and 50% indirect light distribution with spacing criteria of 1.6.

LIGHT SOURCE

Custom array of mid-flux LEDs are mounted directly to the housing for optimal thermal performance. Available in 2700K, 3000K, 3500K and 4000K with 90+ CRI and elevated R9 value. Color consistency is maintained to 3 SDCM.

All LEDs have been tested in accordance with IESNA LM-80-08 and results have shown L80 lumen maintenance are greater than 60,000 hours. Absolute product photometry is measured and presented in accordance with IESNA LM-79, unless otherwise indicated.

ELECTRICAL

Factory-set, adjustable output current LED driver with universal (120-277VAC) input. Dimmable from 100% to 1% with 0-10V dimming control. Rated life (90% survivorship) of 50,000 hours at 50°C max. ambient (and 70°C max. case) temperature. At maximum driver load: Efficiency > 84%, PF > 0.9, THD < 20%. Other specifiable options include Lutron Hi-Lume 1% Eco, eldoLED 1% ECOdrive 0-10V, eldoLED 0.1% SOLOdrive 0-10V, and DALI protocol drivers. All of our standard 0-10V drivers are NEMA 410 compliant.

PoE

Depending on the PoE manufacturer selected, Lumenwerx will install the node in factory as either integral to the luminaire or as a remote module. Factory programming of the PoE node may or may not enable the following functionalities: lumen package, DUO (tunable white), QUADRO (RGBW), emergency battery backup, and sensor integration. These must be addressed and evaluated on a case-by-case basis.

FINISH

Interior: 95% reflective, matte white powder coating

Exterior: Matte white, matte black or aluminum powder coating.

Custom finishes are also available.

CONSTRUCTION

Housing: Rolled and seamlessly welded aluminum

Lens: Coextruded polycarbonate

WEIGHT

Ø 12": 1.57 lbs - 0.7 kg

Ø 18": 2.36 lbs - 1.1 kg

Ø 24": 3.14 lbs - 1.4 kg

Ø 36": 4.71 lbs - 2.1 kg

Ø 48": 6.28 lbs - 2.8 kg

Ø 60": 7.85 lbs - 3.6 kg

Ø 72": 9.42 lbs - 4.3 kg

CERTIFICATION

ETL: Rated for indoor dry/damp locations. Conforms to UL Standard 1598 and certified to CAN/CSA Standard C22.2 No. 250.0.

WARRANTY

Lumenwerx provides a five-year limited warranty on electrical and mechanical performance of the luminaires, including the LED boards, drivers, and auxiliary electronics. Lumenwerx will repair or replace defective luminaires or components at our discretion, provided they have been installed and operated in accordance with our specifications. Other limitations apply, please refer to the full warranty on our website.