

# RIM TRIANGLE & HEXAGON



PENDANT  
STATIC WHITE



Project: \_\_\_\_\_

Type: \_\_\_\_\_

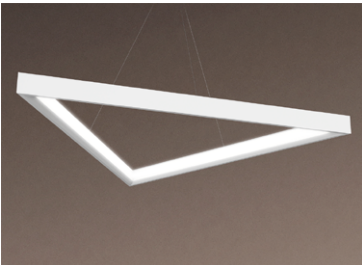

## DESCRIPTION

### RIM TRIANGLE

Available in five standard sizes, from 2' to 6' sides, the equilateral Rim Triangle fixtures are decorative with a sleek profile suitable in any interior environment, especially when combined with general lighting, wall wash, and/or perimeter effects. Rim Triangle is equipped with LED arrays illuminating inward from its triangular housing. Certain smaller Rim Triangle sizes can be combined (two to three fixtures only) to form Rim Multiple Triangle luminaires. Rim Triangle nominal light output ranges from 2000 to 11400 lumens. It is also available with Chromawerx Sola, Duo, and Quadro (consult factory).



### RIM HEXAGON

Available in three standard sizes, from 2' to 4' sides, Rim Hexagon fixtures are decorative with a sleek profile suitable in any interior environment, especially when combined with general lighting, wall wash, and/or perimeter effects. Rim Hexagon is equipped with LED arrays illuminating inward from its hexagonal housing. Rim Hexagon sizes can be combined (two to three fixtures only) to form Rim Multiple Hexagon luminaires. Rim Hexagon nominal light output ranges from 3900 to 15300 lumens. It is also available with Chromawerx Sola, Duo, and Quadro (consult factory).

Up to 90 lm/W performance

## Order Guide

LUMINAIRE ID	SIZE <sup>1</sup>	OPTIC		LIGHT SOURCE <sup>2</sup>		CRI	LUMEN PACKAGE			COLOR TEMP.	VOLTAGE
		ULO	SW	SW	90CRI						
<b>RIMTP</b> - Rim Triangle Pendant <b>RIMHP</b> - Rim Hexagon Pendant	<u>Triangle</u> <b>T24IN</b> - 24" side Triangle <b>T36IN</b> - 36" side Triangle <b>T48IN</b> - 48" side Triangle <b>T60IN</b> - 60" side Triangle <b>T72IN</b> - 72" side Triangle	<b>ULO</b> - Uniform Lambertian Optic	<b>SW</b> - Static white  <sup>2</sup> Chromawerx SOLA, DUO, and QUADRO also available. Consult factory.	<b>90CRI</b> - 90 CRI	T-24" T-36" T-48" T-60" T-72" H-24" H-36" H-48"	Low <b>2000LM</b> Medium <b>2900LM</b> <b>4300LM</b> <b>5800LM</b> <b>7200LM</b> <b>8600LM</b> <b>11400LM</b>	High <b>3800LM</b> <b>5700LM</b> <b>7600LM</b> <b>9500LM</b> <b>11400LM</b> <b>4400LM</b> <b>6600LM</b> <b>8800LM</b>	<b>27K</b> - 2700K <b>30K</b> - 3000K <b>35K</b> - 3500K <b>40K</b> - 4000K	<b>120V</b> - 120V <b>277V</b> - 277V <b>UNV</b> - 120V-277V <b>347V</b> <sup>3</sup> -347V		
	<u>Hexagon</u> <b>H24IN</b> - 24" side-to-side Hexagon <b>H36IN</b> - 36" side-to-side Hexagon <b>H48IN</b> - 48" side-to-side Hexagon										
<sup>1</sup> Other sizes available; shipped in separate pieces. Consult factory.											

REMOTE DRIVER <sup>4</sup>	ELECTRICAL <sup>6</sup>	MOUNTING				FINISH													
	<b>1C</b>																		
<b>DI</b> - 1% 0-10V <b>DA</b> <sup>5</sup> - DALI <b>LDE1</b> <sup>5</sup> - Lutron Hi-Lume 1% Eco <b>ELD1</b> - eldoLED 1% ECOdrive 0-10V <b>ELDO</b> - eldoLED0.1% SOLOdrive 0-10V  <sup>4</sup> PoE (Power-over-Ethernet) compatible. Consult factory for details. <sup>5</sup> On-site commissioning is required.	<b>1C</b> - 1 circuit  <sup>6</sup> For other circuit configurations, consult factory.	<b>DRIVER BOX</b> <sup>7</sup> <b>RCD</b> <sup>8,9</sup> - Round canopy driver box <b>RDB</b> <sup>10</sup> - Remote driver box  <sup>7</sup> For more information see page 4. <sup>8</sup> With single canopy option, not available for lumen packages over 6000 lm (3500 lm for Lutron driver options). <sup>9</sup> Not available with 347V. <sup>10</sup> Multiple remote driver boxes may be necessary for lumen packages higher than 10000 lm.	<b>CANOPY FINISH</b> <b>W</b> - Matte white <b>AL</b> - Aluminum <b>B</b> - Matte black <b>CF</b> - Custom finish, specify RAL#	<b>POWER</b> <b>POC</b> - Integrated suspension power-over-aircraft cable <b>BAC</b> - Black power cord + aircraft cable <b>WAC</b> - White power cord + aircraft cable	<b>MOUNTING POINTS</b> <b>SC</b> <sup>11</sup> - Single canopy <b>MC</b> <sup>12,13</sup> - Multiple canopies  <sup>11</sup> Only available for up to T-72" and H-48". <sup>12</sup> 3 canopies for Triangle and 4 canopies for Hexagon. <sup>13</sup> With the RCD option, the type of each canopy may differ based on the selected lumen package and driver options. Consult factory for details.	<b>MOUNTING CABLE LENGTH</b> <sup>14</sup> <b>18IN</b> - 18" <b>24IN</b> - 24" <b>36IN</b> - 36" <b>48IN</b> - 48" <b>60IN</b> - 60"  <sup>14</sup> Minimum mounting heights are based on the size of the ring on top (closest to ceiling) of the stack:		<b>W</b> - Matte white <b>AL</b> - Aluminum <b>B</b> - Matte black <b>CF</b> - Custom finish, specify RAL#											
		<table border="1"> <thead> <tr> <th>Fixture size</th> <th>Minimum height</th> </tr> </thead> <tbody> <tr> <td>T-24" - 24" side</td> <td>min. height 12.5"</td> </tr> <tr> <td>T-36" - 36" side</td> <td>min. height 18.5"</td> </tr> <tr> <td>T-48" - 48" side</td> <td>min. height 25"</td> </tr> <tr> <td>T-60" - 60" side</td> <td>min. height 31"</td> </tr> <tr> <td>T-72" - 72" side</td> <td>min. height 37.5"</td> </tr> <tr> <td>H-24" - 24" side-to-side</td> <td>min. height 28.5"</td> </tr> <tr> <td>H-36" - 36" side-to-side</td> <td>min. height 43"</td> </tr> <tr> <td>H-48" - 48" side-to-side</td> <td>min. height 57.5"</td> </tr> </tbody> </table>		Fixture size	Minimum height	T-24" - 24" side	min. height 12.5"		T-36" - 36" side	min. height 18.5"	T-48" - 48" side	min. height 25"	T-60" - 60" side	min. height 31"	T-72" - 72" side	min. height 37.5"	H-24" - 24" side-to-side	min. height 28.5"	H-36" - 36" side-to-side
Fixture size	Minimum height																		
T-24" - 24" side	min. height 12.5"																		
T-36" - 36" side	min. height 18.5"																		
T-48" - 48" side	min. height 25"																		
T-60" - 60" side	min. height 31"																		
T-72" - 72" side	min. height 37.5"																		
H-24" - 24" side-to-side	min. height 28.5"																		
H-36" - 36" side-to-side	min. height 43"																		
H-48" - 48" side-to-side	min. height 57.5"																		

[See website for the Pendant Mounting Guide](#)



# RIM TRIANGLE & HEXAGON



PENDANT  
STATIC WHITE

## Dimensions

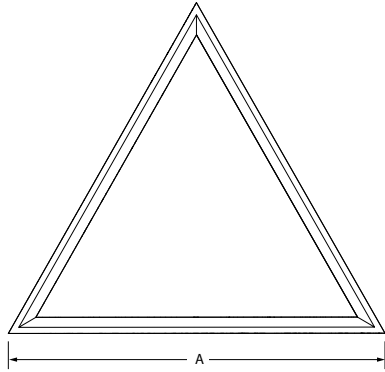

SIZE	A
	SIDE LENGTH
T-24"	24 9/16"
T-36"	36 9/16"
T-48"	48 9/16"
T-60"	60 9/16"
T-72"	72 9/16"

**RIMTP** - Rim Triangle Pendant

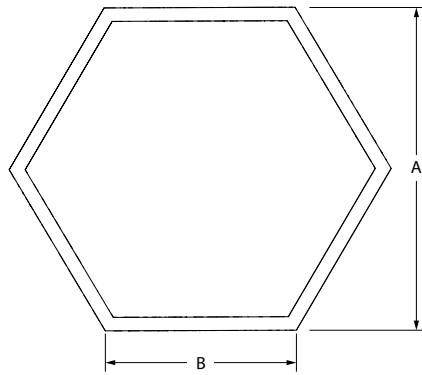

SIZE	A	B
	SIDE-TO-SIDE LENGTH	SIDE LENGTH
H-24"	24 5/8"	14 3/16"
H-36"	36 5/8"	21 1/8"
H-48"	48 5/8"	28 1/16"

**RIMHP** - Rim Hexagon Pendant

## Section Views

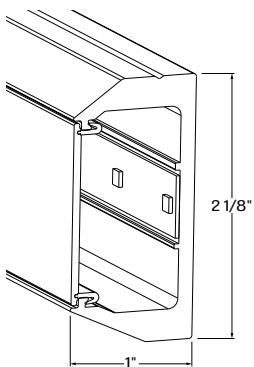

**RIMTP** - Rim Triangle Pendant

**RIMHP** - Rim Hexagon Pendant

# RIM TRIANGLE & HEXAGON



PENDANT  
STATIC WHITE

## Photometrics

RIMTP - RIM TRIANGLE PENDANT - Delivered lumens at 40K at 90 CRI

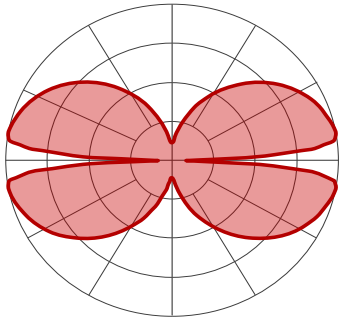

T-24" - 24" side

LED output	WATTS	NOMINAL DELIVERED LUMENS	LPW
Low	22.2	2000	90
Medium	33.3	2900	87
High	45.2	3800	84

T-36" - 36" side

LED output	WATTS	NOMINAL DELIVERED LUMENS	LPW
Low	32.2	2900	90
Medium	49.4	4300	87
High	67.9	5700	84

T-48" - 48" side

LED output	WATTS	NOMINAL DELIVERED LUMENS	LPW
Low	43.3	3900	90
Medium	66.7	5800	87
High	90.5	7600	84

T-60" - 60" side

LED output	WATTS	NOMINAL DELIVERED LUMENS	LPW
Low	54.4	4900	90
Medium	82.8	7200	87
High	113.1	9500	84

T-72" - 72" side

LED output	WATTS	NOMINAL DELIVERED LUMENS	LPW
Low	64.4	5800	90
Medium	98.9	8600	87
High	135.7	11400	84

RIMHP - RIM HEXAGON PENDANT - Delivered lumens at 40K at 90 CRI

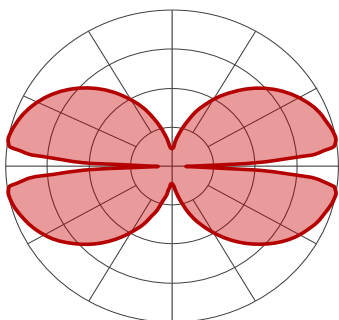

H-24" - 24" side-to-side

LED output	WATTS	NOMINAL DELIVERED LUMENS	LPW
Low	25.6	2300	90
Medium	39.1	3400	87
High	52.4	4400	84

H-36" - 36" side-to-side

LED output	WATTS	NOMINAL DELIVERED LUMENS	LPW
Low	37.8	3400	90
Medium	57.5	5000	87
High	78.6	6600	84

H-48" - 48" side-to-side

LED output	WATTS	NOMINAL DELIVERED LUMENS	LPW
Low	51.1	4600	90
Medium	77	6700	87
High	104.8	8800	84

### MULTIPLIER TABLES

Please follow the multiplier tables to ensure correct lumen value.

CCT and CRI, will change the lumen output.

Multiplier @ 90 CRI

CCT (K)	Watts	LPW
2700	1.08	0.92
3000	1.05	0.96
3500	1.02	0.98
4000	1.00	1.00

# RIM TRIANGLE & HEXAGON



PENDANT  
STATIC WHITE

## Mounting Options

### RCD - ROUND CANOPY DRIVER BOX

#### SC - SINGLE CANOPY

#### MC - MULTIPLE CANOPY

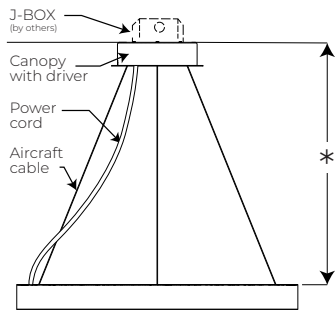

AC - Aircraft cable

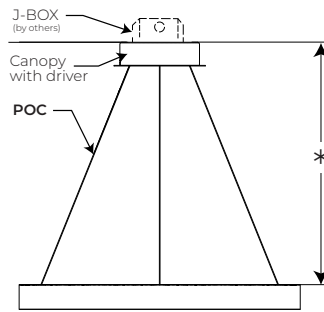

POC - Power-over-aircraft cable

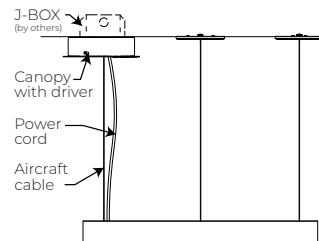

AC - Aircraft cable

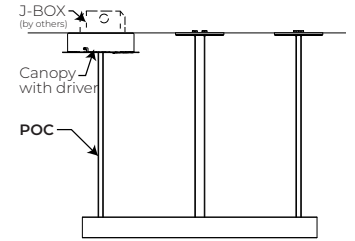

POC - Power-over-aircraft cable

### RDB - REMOTE DRIVER BOX

#### SC - SINGLE CANOPY

#### MC - MULTIPLE CANOPY

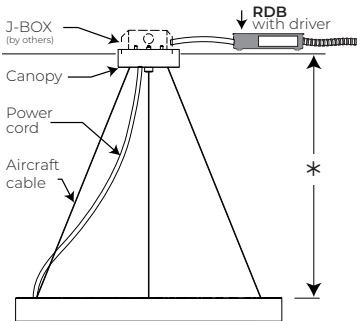

AC - Aircraft cable

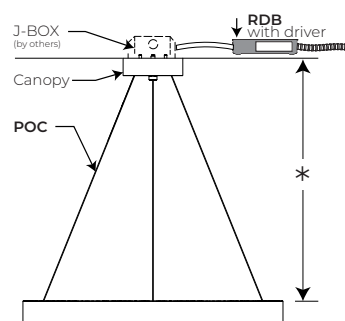

POC - Power-over-aircraft cable

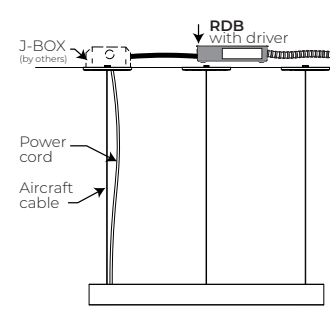

AC - Aircraft cable

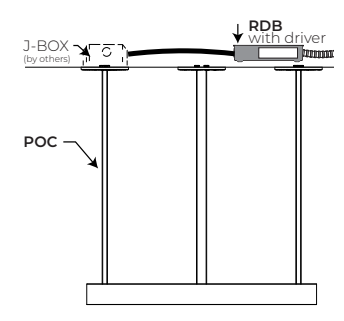

POC - Power-over-aircraft cable

\*minimum height

For single canopy option, the minimum required mounting heights:

Fixture size	* Minimum height
T-24" - 24" side	min. height 12.5"
T-36" - 36" side	min. height 18.5"
T-48" - 48" side	min. height 25"
T-60" - 60" side	min. height 31"
T-72" - 72" side	min. height 37.5"
H-24" - 24" side-to-side	min. height 28.5"
H-36" - 36" side-to-side	min. height 43"
H-48" - 48" side-to-side	min. height 57.5"

# RIM TRIANGLE & HEXAGON



PENDANT  
STATIC WHITE

## Technical Specifications

### OPTIC

**Uniform Lambertian Optic (ULO)** - Thermoformed from impact-modified white PMMA, the ULO provides even luminosity, with up to 88% transmission. Combined with the LED array running around the inside of the housing, the open form and ULO create a widespread 50% direct and 50% indirect light distribution with spacing criteria of 1.6.

### LIGHT SOURCE

Custom array of mid-flux LEDs are mounted directly to the housing for optimal thermal performance. Available in 2700K, 3000K, 3500K and 4000K with 90 CRI and elevated R9 value. Color consistency is maintained to 3 SDCM. LEDs are operated at a reduced drive current to optimize efficacy and lumen maintenance. All LEDs have been tested in accordance with IESNA LM-80-08 and results have shown L80 lumen maintenance are greater than 60,000 hours. Absolute product photometry is measured and presented in accordance with IESNA LM-79, unless otherwise indicated.

### JOINER

For sizes that are shipped in separate pieces, all sections are joined together on site using pre-installed die cast joiners.

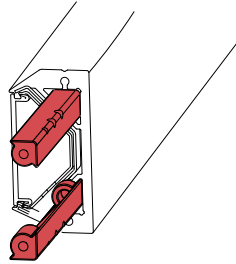

### ELECTRICAL

Factory-set, adjustable output current LED driver with universal (120-277VAC) input. Dimmable from 100% to 1% with 0-10V dimming control. Rated life (90% survivorship) of 50,000 hours at 50°C max. ambient (and 70°C max. case) temperature. At maximum driver load: Efficiency > 84%, PF > 0.9, THD < 20%. Other specifiable options include Lutron Hi-Lume 1% Eco, eldoLED 1% ECOdrive 0-10V, eldoLED 0.1% SOLOdrive 0-10V, and DALI protocol drivers. All of our standard 0-10V drivers are NEMA 410 compliant.

### PoE

Depending on the PoE manufacturer selected, Lumenwerx will install the node in factory as either integral to the luminaire or as a remote module. Factory programming of the PoE node may or may not enable the following functionalities: lumen package, Duo (tunable white), Quadro (RGBW), emergency battery backup, and sensor integration. These must be addressed and evaluated on a case-by-case basis.

### FINISH

**Interior** - 95% reflective, matte white powder coating  
**Exterior** - Matte white, matte black or aluminum powder coating. Custom finishes are also available.

### CONSTRUCTION

**Housing** - Rolled and seamlessly welded aluminum extrusion, wide variety of colored powder coating  
**Diffuser** - Uniform Lambertian optic, co-extruded flexible polycarbonate satine finished lens

### WEIGHT

TRIANGLE		HEXAGON	
24" side	4.8lbs - 2.1kg	24" side-to-side	9.6lbs - 4.3kg
36" side	7.2lbs - 3.2kg	36" side-to-side	14.4lbs - 6.5kg
48" side	9.6lbs - 4.3kg	48" side-to-side	19.2lbs - 8.7kg
60" side	12.0lbs - 5.4kg		
72" side	14.4lbs - 6.5kg		

### CERTIFICATION

**ETL** - Rated for Indoor Dry/Damp locations. Conforms to UL Standard 1598 and certified to CAN/CSA Standard C22.2 No. 250.0.

### WARRANTY

Lumenwerx provides a five-year limited warranty of electrical and mechanical performance of the luminaires, including the LED boards, drivers, and auxiliary electronics. Lumenwerx will repair or replace defective luminaires or components at our discretion, provided they have been installed and operated in accordance with our specifications. Other limitations apply, please refer to the full warranty on our website.