

SQUERO ACOUSTIX



PENDANT
STATIC WHITE, BIOS



DESCRIPTION

Squero Acoustix offers superior craftsmanship that is both optically impressive and sound absorbing. It offers all three standard Squero optics: Parabolic Louvers (MBPL, MPL, SPL), Miniature Reflector Optic (MRO), and High-Efficiency Lambertian Optic (HLO). Coupled with excellent optical choice, the acoustic felt is cut with an ultra-fine blade to ensure flawless transitions at every cut corner and seam. Squero Acoustix is available in static white and BIOS. For SOLA and DUO, please see other spec sheet.

SENSORS
For latest information on sensors, click [here](#).



Up to 145 lm/W performance

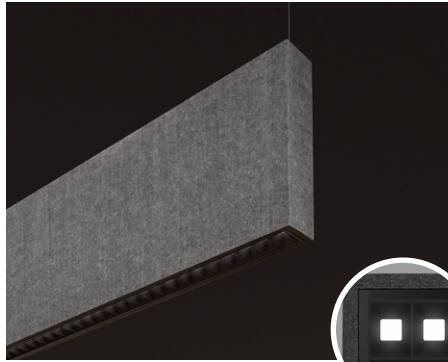

MBPL
Matte Black Parabolic Louver

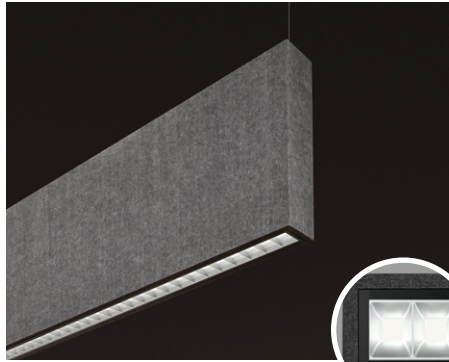

MPL
Matte Parabolic Louver

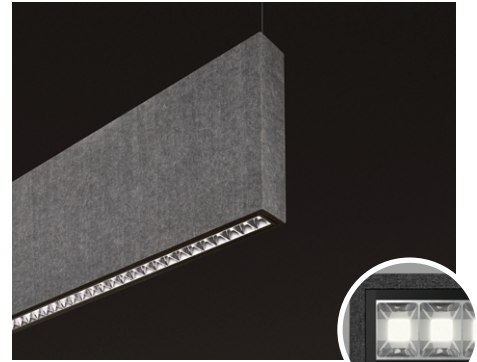

SPL
Specular Parabolic Louver

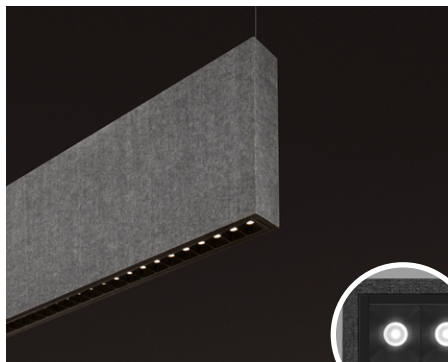

MRO
Miniature Reflector Optics



HLO
High-Efficiency Lambertian Optic

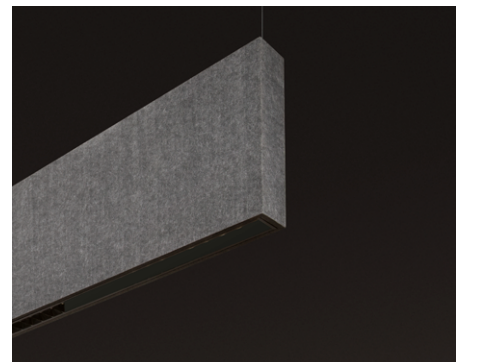

BLA
Blank

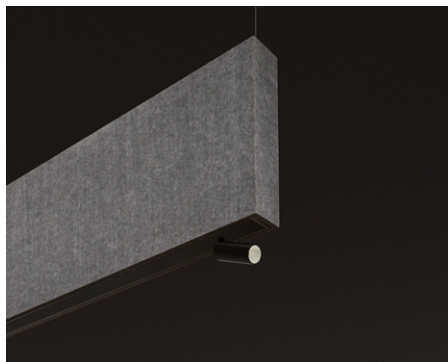

AAM
Adjustable Accent Module

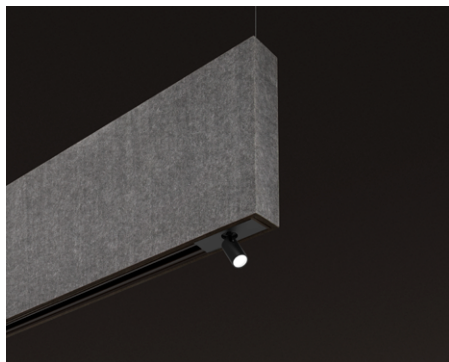

MS
Micro Spot Module



SQUERO ACOUSTIX



PENDANT
STATIC WHITE, BIOS

Project: _____
Type: _____

Order Guide

LUMINAIRE ID	DISTRIBUTION	LUMINAIRE HEIGHT	DIRECT OPTIC	MRO COLOR	INDIRECT OPTIC Specify NA for Direct fixture	LIGHT SOURCE ⁸
SQUACOP						
SQUACOP - Squero Acoustix Pendant	DI - Direct/Indirect D - Direct	8IN - 8" 12IN - 12" 16IN - 16"	MRO18 ¹ - 18 degree Miniature Reflector Optic MRO35 ¹ - 35 degree Miniature Reflector Optic MRO55 ¹ - 55 degree Miniature Reflector Optic MBPL ² - Matte Black Parabolic Louver MPL ² - Matte Parabolic Louver SPL ² - Specular Parabolic Louver HLO - High-Efficiency Lambertian Optic BLA ^{3,4} - Blank ¹ Not available with BIOS. ² Not available with BIOSTU. ³ Specify with AAM or Micro Spot option. ⁴ Can also be specified as the direct optic option for a Direct/Indirect fixture.	WH ⁵ - White BK ⁵ - Black NA - Not applicable ⁵ Only available with MRO optics.	WIO2 ⁶ - Widespread Indirect Optic TIO ⁷ - Translucent Indirect Optic WAI2 ⁷ - Widespread Asymmetric Indirect Optic NA - Not applicable ⁶ Not available with BIOSTU. ⁷ Not available with BIOS.	SW - Static white BIOSS2 ⁹ - BIOS Biological Static BIOSDY ⁹ - BIOS Biological Dynamic BIOSTU ⁹ - BIOS Biological Tunable ⁸ Chromawerx SOLA and DUO also available. Consult other spec sheet. ⁹ See page 9 for details.

CRI	DIRECT LUMEN PACKAGE Specify NA for Blank	INDIRECT LUMEN PACKAGE Specify NA for Direct fixture	COLOR TEMP.	LUMINAIRE LENGTH
80CRI - 80+ CRI 90CRI ¹⁰ - 90+ CRI ¹⁰ Not available with BIOS.	350LMF - Eco low output 350 lm/ft 500LMF - Low output 500 lm/ft 750LMF - Medium output 750 lm/ft 1000LMF ^{11,12} - High output 1000 lm/ft NA - Not applicable ¹¹ Not available with MBPL optic. ¹² Not available with BIOS.	350LMF - Eco low output 350 lm/ft 500LMF - Low output 500 lm/ft 750LMF - Medium output 750 lm/ft 1000LMF ^{13,14,15} - High output 1000 lm/ft NA - Not applicable ¹³ Not available with WAI2. ¹⁴ For Direct/Indirect, Direct must not exceed 750 lm/ft. ¹⁵ Not available with BIOS.	27K ¹⁶ - 2700K 30K - 3000K 35K - 3500K 40K - 4000K 50K ¹⁶ - 5000K ¹⁶ Not available with BIOS.	#FT#IN - Specify nominal length (#) in 2' increments Standard nominal lengths: Single units: 4' to 12' Continuous runs: lengths over 12'

VOLTAGE	DRIVER ¹⁸	ELECTRICAL	ELECTRICAL SECTIONS (optional) ^{25, 26}	MOUNTING ³¹
120V - 120V 277V - 277V UNV - 120V-277V 347V ¹⁷ - 347V ¹⁷ Available with DI driver only.	DI - 1% 0-10V ELV ¹⁹ - ELV 120V TRI ¹⁹ - TRIAC 120V DA ²⁰ - DALI LDE1 ²⁰ - Lutron Hi-lume 1% Eco ELD1 - eldoLED 1% ECOdrive 0-10V ELDO - eldoLED 0.1% SOLOdrive 0-10V ¹⁸ PoE (Power-over-Ethernet) compatible. Consult factory for details. ¹⁹ Available with 120V only. ²⁰ On-site commissioning is required.	1C - 1 circuit 2C ²¹ - 2 circuits #MC ²² - Multi circuit EC - Emergency-powered fixture NL - Night light fixture DL - Daylight fixture GTD ^{23,24} - Generator transfer device fixture ²¹ Available for Direct/Indirect only. Separate direct and indirect circuits. ²² Specify total number of circuits (#), including any required for electrical section or module options. Provide drawing or layout specifications. Minimum 4' section per circuit. ²³ Minimum 4' fixture. ²⁴ Not available with 347V.	#EC## ²⁷ - Emergency-powered section #NL## ²⁷ - Night light section #DL## ²⁷ - Daylight section #GTD## ^{27,28,29} - Generator transfer device section #EMB ^{29,30} - Emergency battery NA - None ²⁵ Specify with multi circuit (#MC) electrical option only. ²⁶ Provide drawing or layout specifications. Consult factory for other configurations. Default section length is 4'. ²⁷ Specify quantity (#), and section length in inches (##). ²⁸ Minimum 4' section. ²⁹ Not available with 347V. ³⁰ Specify quantity (#). All batteries will be on the same circuit. Each battery powers a 4' section. For Direct/Indirect, minimum 8' fixture.	ACS - Aircraft cable, standard STS - Stem, standard ACC() - Aircraft cable, custom STC() - Stem, custom ³¹ Standard canopies are black for black fixtures, and white for all other finishes. See page 3 for full details on standard and custom options.

FIXTURE FINISH ³²	FELT COLOR	OPTIONS ³⁵	MODULE (optional) ^{37, 38}	
W - Matte white AL - Aluminum B - Matte black CF# - Custom finish, specify RAL# ³² Blank finish will match fixture finish.	STANDARD COLORS FWN LVN FON LEN ION CYN TBN PMN MDN FGN	PREMIUM COLORS ^{33,34} PKN CDN IVN BHN OGN LCN SLN CFN LNN SYN CNN GRN LMN BLN GHN MON EGN NVN CLN ESN ³³ Please consult factory for more color options. ³⁴ Lead time may vary.	FUI20 - Fuse 120V FU277 - Fuse 277V CTB9 ³⁶ - T-bar caddy clip, 9/16" CTB15 ³⁶ - T-bar caddy clip, 15/16" CTG9 ³⁶ - Tegular caddy clip, 9/16" CTG15 ³⁶ - Tegular caddy clip, 15/16" CST ³⁶ - Screw slot caddy clip NA - None ³⁵ Separate codes with a "*" if more than one is specified. ³⁶ Available with aircraft cable only.	#AAM21() - AAM 21° #AAM30() - AAM 30° #AAM36() - AAM 36° #MS25() - Micro Spot 25° #MS35() - Micro Spot 35° #MS50() - Micro Spot 50° NA - None ³⁷ See page 3 for ordering details. ³⁸ Not available with ELV/TRI driver options.



SQUERO ACOUSTIX



PENDANT

STATIC WHITE, BIOS

Module Code

For a module, specify the options in the parentheses.
The light source is static white.
CRI of module matches specification of main fixture.

Examples: 1AAM21(5W-35K-W-NA)
1MS25(5W-27K-W)

MODULE (optional)				
MODULE ^{1,2}	WATTAGE	COLOR TEMPERATURE	FINISH	OPTION
#AAM21() - AAM 21° #AAM30() - AAM 30° #AAM36() - AAM 36° ¹ Specify quantity (#). ² 6" blank per module. Blank finish will match fixture finish.	5W - 5 W, up to 364 lm output 8W - 8 W, up to 624 lm output	27K - 2700K 30K - 3000K 35K - 3500K 40K - 4000K 50K - 5000K	W - Matte white B - Matte black	HCL - Honeycomb louver NA - None
MODULE ^{1,2}	WATTAGE	COLOR TEMPERATURE	FINISH	
#MS25() - Micro Spot 25° #MS35() - Micro Spot 35° #MS50() - Micro Spot 50° ¹ Specify quantity (#). ² 6" blank per module. Blank finish will match fixture finish.	5W - 5 W, up to 430 lm output	27K - 2700K 30K - 3000K 35K - 3500K 40K - 4000K 50K - 5000K	W - Matte white B - Matte black	

Pendant Mounting Code

Aircraft Cable

Standard

ACS - Aircraft cable, standard

- Ø 5" for power canopy
- Ø 3" for non-power canopy
- Canopies are black for black fixtures, and white for all other fixture finishes
- Power cord is black for black fixtures, and white for all other fixture finishes
- Aircraft cable length is 36"

Custom

Example: ACC(3NPC-72IN-W-PCB-NA)

ACC() - Aircraft cable, custom

NON-POWER CANOPY SIZE	AIRCRAFT CABLE LENGTH	CANOPY FINISH	POWER CORD COLOR	OPTION
3NPC - Ø 3" non-power canopy 5NPC - Ø 5" non-power canopy	36IN - 36" 72IN - 72" 120IN - 120" #IN ¹ - Other lengths, specify in inches ¹ Maximum length is 288". For longer lengths, please consult factory.	W - Matte white AL - Aluminum B - Matte black CF# - Custom finish, specify RAL#	PCW - White PCB - Black	SEM ² - Seismic mounting SLS ² - Sloped ceiling for aircraft cable NA - None ² Not available with the Ø 3" non-power canopy size.

Stem

Standard

STS - Stem, standard

- Ø 5" for power canopy
- Ø 5" for non-power canopy
- Canopies are black for black fixtures, and white for all other fixture finishes
- Stem finish is the same color as fixture
- Stem length is 18"
- Stem is not field adjustable

Custom

Example: STC(5NPC-36IN-W-STW-SLS)

STC() - Stem, custom

NON-POWER CANOPY SIZE	STEM LENGTH	CANOPY FINISH	STEM COLOR	OPTION
5NPC - Ø 5" non-power canopy	18IN - 18" 36IN - 36" #IN ³ - Specify length in inches ³ Minimum length is 6". Maximum length is 72". Stem is not field adjustable.	W - Matte white AL - Aluminum B - Matte black CF# - Custom finish, specify RAL#	STW - Matte white STAL - Aluminum STB - Matte black STCF# - Custom finish, specify RAL#	SLS - Sloped ceiling for stem NA - None

SQUERO ACOUSTIX



PENDANT

STATIC WHITE, BIOS

Standard Color Options

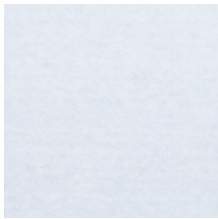

FWN - FROST WHITE

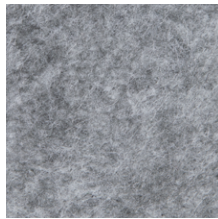

FON - FOG

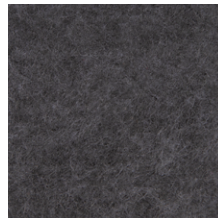

ION - IRON

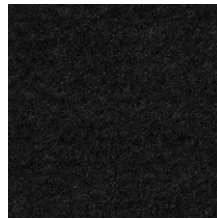

TBN - TRUE BLACK



MDN - MIDNIGHT BLUE



LVN - LAVENDER



LEN - LATTE



CYN - CHERRY



PMN - PLUM



FGN - FOREST GREEN

Premium Color Options*



PKN - PAPRIKA



OGN - ORANGE



LNN - LEMON



LMN - LIME



EGN - EVERGREEN



CDN - CLOUDY

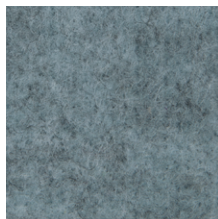

LCN - LICHEN



SYN - SKY



BLN - BLUEBERRY



NVN - NAVY



IVN - IVORY



SLN - STEEL



CNN - CARBON

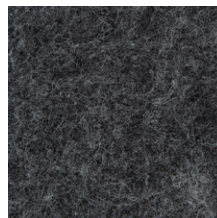

GHN - GRAPHITE

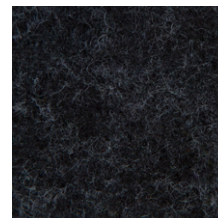

CLN - CHARCOAL



BHN - BLUSH



CFN - CAFÉ



GRN - GREIGE



MON - MOCHA



ESN - ESPRESSO

*Please consult factory for more color options.
*Lead time may vary.

SQUERO ACOUSTIX



PENDANT

STATIC WHITE, BIOS

Dimension

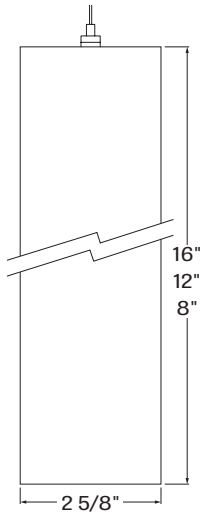

SQUERO ACOUSTIX



PENDANT
STATIC WHITE, BIOS

Photometrics

Values calculated based on a 4' fixture at 3500K and 80+ CRI for all optics.

DIRECT OPTICS

MRO18

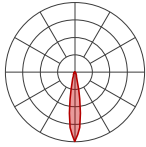

LM/FT	W/FT	LM/W
350	2.7	130
500	4.0	125
750	6.4	118
1000	9.1	110

MRO35

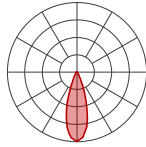

LM/FT	W/FT	LM/W
350	2.9	121
500	4.3	116
750	6.9	108
1000	9.9	101

MRO55

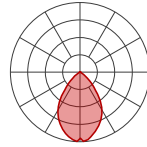

LM/FT	W/FT	LM/W
350	3.2	109
500	4.8	104
750	7.7	97
1000	11.0	91

HLO

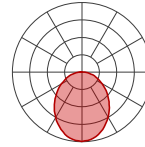

LM/FT	W/FT	LM/W
350	3.1	112
500	4.6	108
750	7.3	103
1000	10.2	98

MBPL

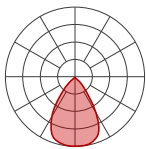

LM/FT	W/FT	LM/W
350	5.2	67
500	7.5	66
750	11.7	64

MPL

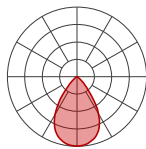

LM/FT	W/FT	LM/W
350	3.5	99
500	5.1	98
750	7.7	98
1000	10.6	95

SPL

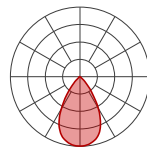

LM/FT	W/FT	LM/W
350	3.1	113
500	4.4	113
750	6.7	112
1000	9.1	109

MULTIPLIER TABLES - CCT/CRI

Use these tables to get results for different color temperatures and CRI for all Direct and Indirect photometric tables.

MRO18 / MRO35 / MRO55

CCT	WATTS		LPW	
	80+ CRI	90+ CRI	80+ CRI	90+ CRI
2700K	1.04	1.19	0.96	0.84
3000K	1.00	1.15	1.00	0.87
3500K	1.00	1.12	1.00	0.89
4000K	0.99	1.10	1.01	0.91
5000K	0.94	1.06	1.06	0.94

MBPL / MPL / SPL

CCT	WATTS		LPW	
	80+ CRI	90+ CRI	80+ CRI	90+ CRI
2700K	1.04	1.19	0.96	0.84
3000K	1.00	1.15	1.00	0.87
3500K	1.00	1.12	1.00	0.89
4000K	0.99	1.10	1.01	0.91
5000K	0.94	1.06	1.06	0.94

HLO

CCT	WATTS		LPW	
	80+ CRI	90+ CRI	80+ CRI	90+ CRI
2700K	1.05	1.27	0.95	0.79
3000K	1.02	1.23	0.98	0.81
3500K	1.00	1.19	1.00	0.84
4000K	1.00	1.19	1.00	0.84
5000K	0.96	1.12	1.04	0.89

SQUERO ACOUSTIX



PENDANT

STATIC WHITE, BIOS

Values calculated based on a 4' fixture at 3500K and 80+ CRI for all optics.

INDIRECT OPTICS

WIO2

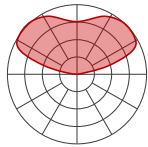

LM/FT	W/FT	LM/W
350	2.4	145
500	3.5	141
750	5.5	136
1000	7.7	130

TIO

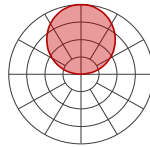

LM/FT	W/FT	LM/W
350	2.8	127
500	4.0	124
750	6.3	119
1000	8.8	114

WAI2

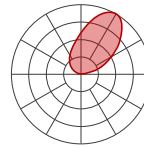

LM/FT	W/FT	LM/W
350	2.5	139
500	3.7	135
750	5.8	130

MULTIPLIER TABLES - CCT/CRI

Use these tables to get results for different color temperatures and CRI for all Direct and Indirect photometric tables.

WIO2 / TIO / WAI2

CCT	WATTS		LPW	
	80+ CRI	90+ CRI	80+ CRI	90+ CRI
2700K	1.05	1.27	0.95	0.79
3000K	1.02	1.23	0.98	0.81
3500K	1.00	1.19	1.00	0.84
4000K	1.00	1.19	1.00	0.84
5000K	0.96	1.12	1.04	0.89

DIRECT/INDIRECT - LPW CALCULATION

For Direct/Indirect performance values, follow the formula.

$$\left(\frac{\text{DIRECT LM/FT} + \text{INDIRECT LM/FT}}{\text{DIRECT W/FT} + \text{INDIRECT W/FT}} \right) = \text{LPW}$$

AAM MODULE

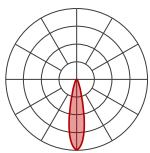

AAM 21°

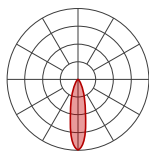

AAM 30°

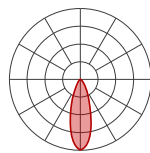

AAM 36°

DELIVERED LUMENS

Wattage	5.0									
CRI	80+					90+				
CCT	2700K	3000K	3500K	4000K	5000K	2700K	3000K	3500K	4000K	5000K
Lumen	323	340	350	357	364	265	279	289	299	312
Wattage	8.0									
CRI	80+					90+				
CCT	2700K	3000K	3500K	4000K	5000K	2700K	3000K	3500K	4000K	5000K
Lumen	553	583	600	612	624	454	478	495	513	534

MICRO SPOT MODULE

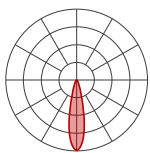

Micro Spot 25°

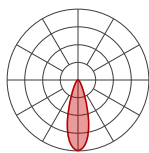

Micro Spot 35°

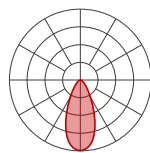

Micro Spot 50°

DELIVERED LUMENS

Wattage	5.0									
CRI	80+					90+				
CCT	2700K	3000K	3500K	4000K	5000K	2700K	3000K	3500K	4000K	5000K
Lumen	373	400	400	432	432	324	344	344	345	372

SQUERO ACOUSTIX



PENDANT

STATIC WHITE, BIOS

Acoustic Calculator

Use the Lumenwerx Acoustix Value Calculator table to determine the number of acoustic luminaires required in a space by fixture type. We have three levels of recommended sound reduction: good, better, and best. Choosing one of these options will reduce the sound accordingly. The best option indicates the best acoustic improvement. Calculations are based on a standard ceiling height of 9'.

Value calculator table

FIXTURE LENGTH	FIXTURE HEIGHT	Room dimensions under 300 sq ft			Room dimensions over 300 sq ft		
		GOOD 😊	BETTER 😊😊	BEST 😊😊😊	GOOD 😊	BETTER 😊😊	BEST 😊😊😊
% in reduction in reverberation time		25%	40%	50%	25%	40%	50%
1'	8"	4.75	2.25	1.5	7.25	3.75	2.5
	12"	7.25	3.5	2	11.25	5.5	3.5
	16"	9.5	4.75	3	14.5	7.25	4.75

Use the Lumenwerx Acoustix Value Formula to determine the number of luminaires needed in the room.

$$\frac{\text{Room square footage (sq ft)}}{\text{Fixture length (ft)} \times \text{Value}} = \text{Number of luminaires.}$$

Example: How many 4' length x 8" height luminaires are needed for a 10' x 10' room size, for a BEST (50%) acoustic:
 $(10' \times 10') \div (4' \times 1.5) = 17$ luminaires

NOTES:

- Lumenwerx acoustic calculators were developed to act as a guide. For precise acoustic performance in a space, please consult an acoustician.



SQUERO ACOUSTIX



PENDANT
STATIC WHITE, BIOS

BIOS

Three BIOS Circadian LED solutions are offered – Biological Static, Biological Dynamic, and Biological Tunable. Use the decision tree below to identify when and where to use BIOS Wellness LED Lighting Solutions.

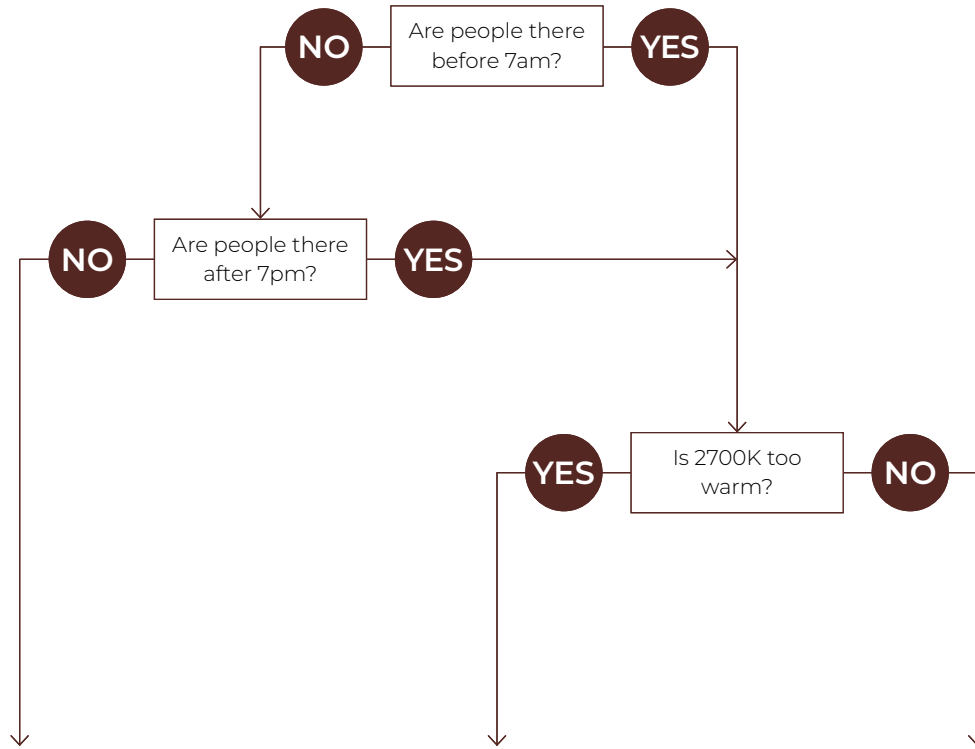

Biological Static BIOSST	Biological Dynamic BIOSDY	Biological Tunable BIOSTU
No CCT change when dimmed	500K shift when dimmed	Dims to 2700K
Daytime solution	Daytime + evening solution	Daytime + evening solution
Spaces in operation during daytime hours, between 7am and 7pm	Spaces in operation overnight, after 7pm and before 7am, and when CCT color shift in the evening is not preferred	Suitable for spaces in operation overnight, after 7pm and before 7am, and where people do not sleep (CCT color shift in the evening is preferred)
E.g. offices, medical/dental offices	E.g. hospitals	E.g. offices, shiftwork



PENDANT

STATIC WHITE, BIOS

Technical Specifications

DIRECT OPTICS

Miniature Reflector Optic (MRO)

Locates individual, precisely molded TIR elements over each LED emitter, and further shield the source with precise parabolic reflectors. The controlled beam is remarkably comfortable – especially in a small LED luminaire.

MRO is available in a specular black or gloss white finish and creates a distinctive visual texture.

Different TIR elements offer a choice of beam spreads: narrow (18° with SC of 0.3), medium (35° with SC of 0.6), and wide (55° with SC of 0.9). These concentrated distributions can provide effective task illumination in a variety of applications.

Each MRO module is 6" long with five optical chambers.



Parabolic Louvers (MBPL, MPL & SPL)

Parabolic Louver Optics provide excellent shielding and a pleasing crisp visual texture. The precisely molded louvers consist of 1" deep blades and side reflectors with shielding of 50° lengthwise and 45° crosswise.

The parabolic contour of the blades and side reflectors direct light into a comfortable downlight distribution with a spacing criterion of 1.1, while minimizing shadows from the LED array above each cell.

Three finishes are available: matte black, matte, and specular. Specular (SPL) provides higher efficacy, sharper cut-off, and an ultra quiet appearance at shallow viewing angles. Matte (MPL) offers a softer appearance, a wider beam spread, and gentle brightness transition at cut-off. Matte black (MBPL) offers the lowest UGR in Squero as the black parabolic louver is very quiet and glare free. The UGR is the best in class rating of under 10.



High-Efficiency Lambertian Optic (HLO)

The High-Efficiency Lambertian Optic (HLO) shielding of diffusing 0.075" thick acrylic with up to 88% transmission and good source obscuration is combined with matte white side reflectors to create an efficient optical chamber with uniform luminosity.

Luminaire brightness is controlled by the flux-to-shielding area ratio. For visual comfort, avoid high lumen output unless Squero is installed in a high ceiling application. Spacing criteria: 1.2 (longitudinal) x 1.1 (lateral).



Blank (BLA)

Blank covers provide spacing – functional or rhythmic – in the direct component of a Squero Combination luminaire. Covers are sized according to the Combination design, finished to match the luminaire housing, and snap into the aperture.



INDIRECT OPTICS

Widespread Indirect Optic (WIO2)

The Widespread Indirect Optic (WIO2) is a horizontal LED array with a widespread indirect micro prismatic optic that offers an impressive 160° spread. WIO2 creates an even illumination for smooth brightness on the ceiling that can achieve uniformity ratios of up to 2:1.

Uniformity [max/min]

Based on 18' continuous runs, in a 20' x 40' room, 10' wall height

Mounting height from ceiling	Spacing (Center to center)		
	8'	10'	12'
12"	5.5	10.0	9.0
18"	3.5	6.0	6.0
24"	2.5	4.0	4.5

Translucent Indirect Optic (TIO)

The Translucent Indirect Optic (TIO) is composed of a horizontal LED array that has a translucent lens to mask pixilation from the diodes. TIO has a 100° spread in the indirect that is ideal when the fixture is mounted farther away from the ceiling.

Widespread Asymmetric Indirect Optic (WAI2)

The Widespread Asymmetric Indirect Optic (WAI2) offers an upward grazing effect with a 45° forward throw. It softly highlights the ceiling in the up-light while distributing the required illumination of the rest of an interior space. For avoiding glare and enjoying visual comfort, WAI2 is an ideal solution.

LIGHT SOURCE

Static white

Custom linear array of high-flux LEDs mounted onto aluminum-backed circuitry with quick-connect wiring to facilitate service and optimize thermal management. Available in 2700K, 3000K, 3500K, 4000K, and 5000K with a minimum 80+ CRI and an option for 90+ CRI with elevated R9 value. Color consistency maintained to within 3 SDCM. All LEDs have been tested in accordance with IESNA LM-80-08 and the results have shown L80 lumen maintenance greater than 60,000 hours. Absolute product photometry is measured and presented in accordance with IESNA LM-79, unless otherwise indicated.

SQUERO ACOUSTIX



PENDANT

STATIC WHITE, BIOS

BIOS

BIOS SkyBlue™ Technology is designed to provide the specific circadian stimulus to improve overall sleep quality, recovery during the night, and overall feelings of well-being. The non-visual light signals that stimulate our circadian system have peak intensity in the "sky blue" region. As the diagram below illustrates, BIOS SkyBlue technology shifts the peak LED spectral intensity (490 nm) to align better with the peak response of circadian stimulus. Also note the enhanced deep-red (near 660 nm) spectrum.

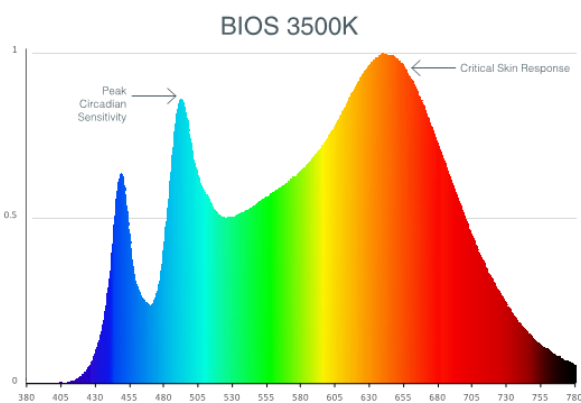

Three BIOS solutions are offered: BIOS Biological Static (BIOSST), BIOS Biological Dynamic (BIOSDY), and BIOS Biological Tunable (BIOSTU). See page 9 for details.

WELL BUILDING STANDARD



WELL for Light: The WELL building standard focuses on light quality in several features. There are three categories that are fully attributed to the construction and features of a luminaire. In WELL V1, it's Feature 54 Circadian Lighting, Feature 55 Glare Control, and Feature 58 Color Quality. In WELL V2, it's Feature L03 Circadian Lighting, Feature L04 Glare Control, and Feature L07 Electric Light Quality.

This fixture meets Features:

- Feature 54 or L03 when BIOS LED is selected
- Feature 55 or L04 meets WELL glare category (b-c-d)
- Feature 58 or L07 when 90+ CRI is selected

All LED drivers used at Lumenwerx are deemed to have a low risk level of flicker, of 5 % or less below 90Hz operational as defined by IEEE standard 1789-2015 LED.



WELL for Sound: This luminaire is recommended for use as an acoustical absorption surface to limit reverberation times (RT) in a given space. This luminaire contributes to noise reduction and vibration dampening to promote focus and concentration. Reverberation needs to be calculated in each space based on the materials used.



WELL for Mind: This luminaire meets WELL for mind as it is a human centric luminaire offering quality light, excellent color, and smooth optics. If any of these features are incorporated in a luminaire, it can improve the ability to focus, concentrate, and persist longer on a given task. This fixture harmoniously operates in a space to assist the mind.

For more information, please contact well@lumenwerx.com

LUMINAIRE LENGTH

Squero Acoustix is available in standard lengths of 4' to 12'. Continuous runs are available for run lengths over 12'. Exact run length must be noted in the product code. The minimum length is 4', and can be ordered in 2' increments. All individual sections are joined together onsite using the joiner kits provided. Lumenwerx offers joiner kits that are extremely simple to work with in the field and result in a fixture that appears virtually seamless with no light leak at any connection.

ELECTRICAL

Factory-set, adjustable output current LED driver with universal (120-277 VAC) input. Dimmable from 100% to 1% with 0-10V dimming control. Rated life (90% survivorship) of 50,000 hours at 50°C max. ambient (and 70°C max. case) temperature. At maximum driver load: Efficiency>84%, PF>0.9, THD<20%. Other specifiable options include Lutron Hi-Lume 1% Eco, eldoLED 1% ECOdrive 0-10V, eldoLED 0.1% SOLOdrive 0-10V, ELV, TRIAC, and DALI protocol drivers. All of our standard 0-10V drivers are NEMA 410 compliant.

PoE

Depending on the PoE manufacturer selected, Lumenwerx will install the node in factory as either integral to the luminaire or as a remote module. Factory programming of the PoE node may or may not enable the following functionalities: lumen package, DUO (tunable white), QUADRO (RGBW), emergency battery backup, and sensor integration. These must be addressed and evaluated on a case-by-case basis.



SQUERO ACOUSTIX



PENDANT

STATIC WHITE, BIOS

ELECTRICAL SECTION OPTIONS

Electrical section options are available for fixtures specified as multi circuit (#MC). With MC, specify the total number of circuits (#), including any circuits required for optional electrical sections. A drawing is required to specify the layout. Please consult factory for custom configurations.

Electrical sections

Options include emergency-powered (#EC##), night light (#NL##), daylight (#DL##), and generator transfer device (#GTD##) sections. Specify the quantity (#), as well as the section length in inches (##).

Example 1: A 32' Direct fixture with two 8' emergency-powered sections on a second circuit.
Code: 2MC-2EC96

Example 2: A 16' Direct/Indirect fixture with separate circuits for direct and indirect, and with one 4' night light section on the direct side on a third circuit.
Code: 3MC-1NL48

Example 3: A 24' Direct fixture with one 4' generator transfer device section.
Code: 1MC-1GTD48

Battery

Each emergency battery (#EMB) powers a 4' section. All batteries will be on the same circuit. Specify the number of batteries (#) required.

Factory installed long life, high temperature, maintenance-free Lithium-Ion battery pack with self-test functionality, test switch and charge indicator. Minimum of 90 minutes operation, up to 1000 lumens per 4' (25°C) emergency lighting output and recharge time of 24 hours.

MOUNTING

Pendant fixtures can be mounted either with aircraft cable or with stem. See page 3 for details.

FINISH

Interior: 95%, reflective matte powder coated white paint

Exterior: Matte white, matte black, or aluminum powder coating. Custom finishes are also available.

ACOUSTIC FINISH

Material is 100% polyester containing up to 50% of recycled plastic bottles (PET) with an ASTM E-84 Class A fire rating and is moisture resistant.

CARE

Remove dust and debris by wiping down with a clean, dry or damp, soft, lint-free cloth, or vacuum.

ADJUSTABLE ACCENT MODULE

The Adjustable Accent Module (AAM) features a $\varnothing 1\ 9/16"$ x $3\ 1/4"$ cylinder that rotates 360° and tilts 90° . The LED light source is coupled with TIR optics to provide beam angles of 21° , 30° , and 36° while producing up to 600 lumens. LED light source CCT options are 2700K, 3000K, 3500K, 4000K, and 5000K, available in either 80+ CRI or 90+ CRI.

The AAM module can be selected in either a white or black finish and a honeycomb louver accessory is also available. The AAM driver is mounted above the cylinder, inside the SQUERO housing and accepts universal input voltage (120-277 VAC) while providing 0-10V dimming control.

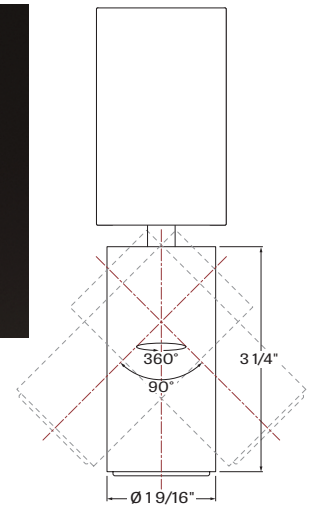

MICRO SPOT MODULE

The Micro Spot is a $\varnothing 7/8"$ x $1\ 5/16"$ adjustable spotlight that extends, retracts, rotates 360° , and tilts 90° . Its LED light source is coupled with a TIR refractor to provide beam angles of 25° , 35° , and 50° , while producing up to 400 lumens. LED light source CCT options are 2700K, 3000K, 3500K, 4000K, and 5000K, available in either 80+ CRI or 90+ CRI. The Micro Spot is offered in a white or black finish. The Micro Spot driver is mounted within the luminaire housing and accepts universal input voltage (120-277 VAC) with 0-10V dimming control.

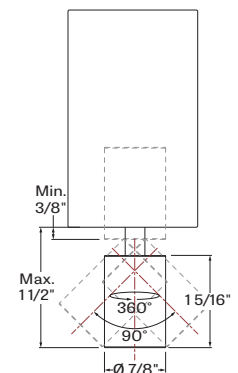
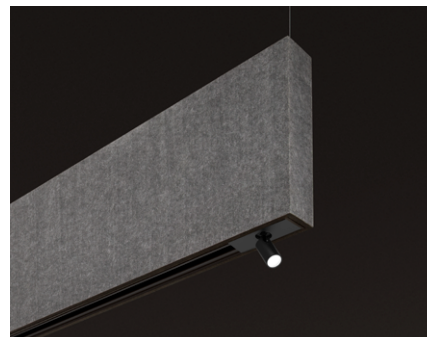

SQUERO ACOUSTIX



PENDANT

STATIC WHITE, BIOS

CONSTRUCTION

Housing: Extruded aluminum, up to 90% recycled content

Interior brackets: Die-formed cold rolled steel sheet

Joining system: Die-cast aluminum

Louvers: Injection molded optical grade polycarbonate, up to 95% reflective

Light guide: Clear PMMA laminated with microstructure film formed into optical TIR/extraction form

End caps: Die-cast aluminum

Hanger: Chromed griplock securely attached in end caps and/or joiners with stainless steel hardware

Aircraft cable suspension: \varnothing 1/16" stainless steel aircraft cable

Stem: \varnothing 1/2" threaded steel tube

WEIGHT

	Direct/Indirect	Direct
4'	21.5 lbs - 9.75 kg	12.57 lbs - 5.70 kg
6'	32.25 lbs - 14.62 kg	25.14 lbs - 11.40 kg

ENVIRONMENT

Ambient temperature at fixture location shall not exceed 30°C/86°F. For indoor use only.

CERTIFICATION

ETL: Rated for indoor dry/damp locations. Conforms to UL Standard 1598 and certified to CAN/CSA Standard C22.2 No. 250.0.

WARRANTY

Lumenwerx provides a five-year limited warranty on electrical and mechanical performance of the luminaires, including the LED boards, drivers, and auxiliary electronics. Lumenwerx will repair or replace defective luminaires or components at our discretion, provided they have been installed and operated in accordance with our specifications. Other limitations apply, please refer to the full warranty on our website.