

# SQUERO ACOUSTIX

PENDANT

CHROMAWERX - SOLA, DUO



## DESCRIPTION

Squero Acoustix offers superior craftsmanship that is both optically impressive and sound absorbing. Coupled with excellent optical choice, the acoustic felt is cut with an ultra-fine blade to ensure flawless transitions at every cut corner and seam. Squero Acoustix is available in SOLA and DUO. For static white and BIOS, please see other spec sheet.

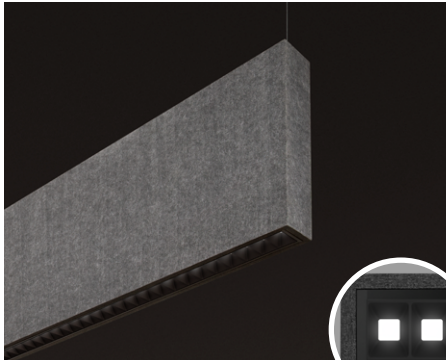

**MBPL**  
Matte Black Parabolic Louver

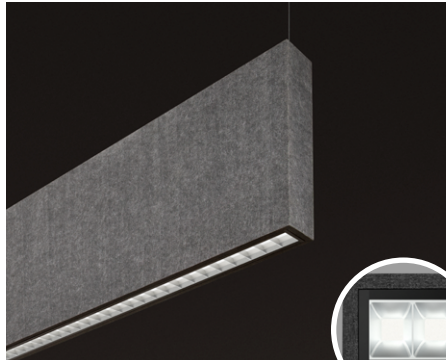

**MPL**  
Matte Parabolic Louver

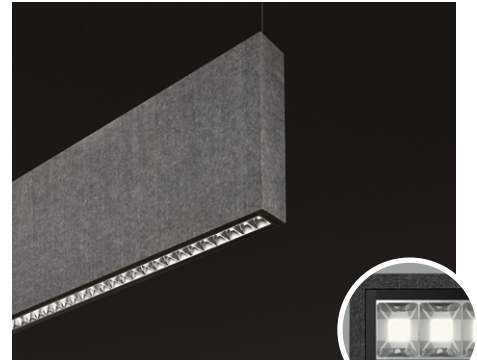

**SPL**  
Specular Parabolic Louver

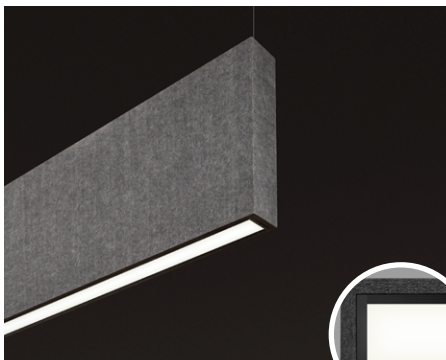

**HLO**  
High-Efficiency Lambertian Optic

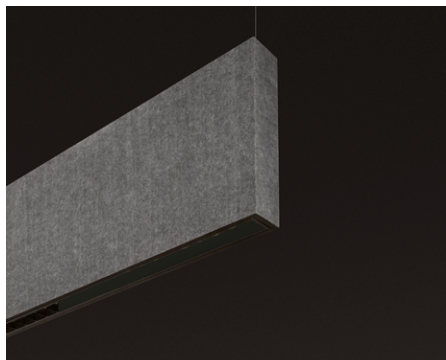

**BLA**  
Blank

# SQUERO ACOUSTIX



PENDANT

CHROMAWERX - SOLA, DUO

Project: \_\_\_\_\_

Type: \_\_\_\_\_

## Order Guide

LUMINAIRE ID	DISTRIBUTION	LUMINAIRE HEIGHT	DIRECT OPTIC	INDIRECT OPTIC Specify NA for Direct fixture	LIGHT SOURCE <sup>2</sup>	CRI
<b>SQUACOP</b>						
<b>SQUACOP</b> - Squero Acoustix Pendant	<b>DI</b> - Direct/Indirect <b>D</b> - Direct	<b>8IN</b> - 8" <b>12IN</b> - 12" <b>16IN</b> - 16"	<b>MBPL</b> - Matte Black Parabolic Louver <b>MPL</b> - Matte Parabolic Louver <b>SPL</b> - Specular Parabolic Louver <b>HLO</b> - High-Efficiency Lambertian Optic <b>BLA</b> <sup>1</sup> - Blank  <sup>1</sup> Can be specified as the direct optic option for a Direct/Indirect fixture.	<b>WIO2</b> - Widespread Indirect Optic <b>TIO</b> - Translucent Indirect Optic <b>WAI2</b> - Widespread Asymmetric Indirect Optic <b>NA</b> - Not applicable	<b>SOLA</b> - Dim-to-warm single channel control 35K to 22K <b>DUO</b> - Tunable white 2-channel control 65K to 27K  <sup>2</sup> Static white and BIOS also available. Consult other spec sheet.	<b>80CRI</b> - 80+ CRI <b>90CRI</b> - 90+ CRI

DIRECT LUMEN PACKAGE Specify NA for Blank	INDIRECT LUMEN PACKAGE Specify NA for Direct fixture	LUMINAIRE LENGTH	VOLTAGE	DRIVER <sup>6</sup>
<b>350LMF</b> - Eco low output 350 lm/ft <b>500LMF</b> - Low output 500 lm/ft <b>750LMF</b> - Medium output 750 lm/ft <b>1000LMF</b> <sup>3</sup> - High output 1000 lm/ft <b>NA</b> - Not applicable  <sup>3</sup> Not available with MBPL optic.	<b>350LMF</b> - Eco low output 350 lm/ft <b>500LMF</b> - Low output 500 lm/ft <b>750LMF</b> - Medium output 750 lm/ft <b>1000LMF</b> <sup>4,5</sup> - High output 1000 lm/ft <b>NA</b> - Not applicable  <sup>4</sup> Not available with WAI2. <sup>5</sup> For Direct/Indirect, Direct must not exceed 750 lm/ft.	<b>#FT#IN</b> - Specify nominal length (#) in 2' increments  <b>Standard nominal lengths:</b> Single units: 4' to 12' Continuous runs: lengths over 12'	<b>120V</b> - 120V <b>277V</b> - 277V <b>UNV</b> - 120V-277V	<b>SOLA</b> <b>SDI</b> - Single 0-10V input  <b>DUO</b> <b>DMX</b> <sup>7,8</sup> - DMX <b>DDA</b> <sup>8</sup> - DALI DT6 <b>DDA8</b> <sup>8</sup> - DALI DT8 <b>DDI</b> - Dual 0-10V input for CCT/intensity <b>LD2</b> <sup>8</sup> - Lutron DALI-2 digital  <sup>6</sup> PoE (Power-over-Ethernet) compatible. Consult factory for details. <sup>7</sup> For more information, see pages 12 to 17. <sup>8</sup> On-site commissioning is required.

ELECTRICAL	MOUNTING <sup>9</sup>	FIXTURE FINISH <sup>11</sup>	FELT COLOR	OPTIONS <sup>14</sup>																																										
<b>1C</b>	<b>ACS</b> - Aircraft cable, standard <b>STS</b> <sup>10</sup> - Stem, standard <b>ACC()</b> - Aircraft cable, custom <b>STC()</b> <sup>10</sup> - Stem, custom  <sup>9</sup> Standard canopies are black for black fixtures, and white for all other finishes. See page 3 for full details on standard and custom options. <sup>10</sup> Not available with DMX.	<b>W</b> - Matte white <b>AL</b> - Aluminum <b>B</b> - Matte black <b>CF#</b> - Custom finish, specify RAL#  <sup>11</sup> Blank finish will match fixture finish.	<table border="1"> <thead> <tr> <th>STANDARD COLORS</th> <th>PREMIUM COLORS <sup>12,13</sup></th> </tr> </thead> <tbody> <tr> <td><b>FWN</b> </td> <td><b>LVN</b> </td> </tr> <tr> <td><b>FON</b> </td> <td><b>LEN</b> </td> </tr> <tr> <td><b>ION</b> </td> <td><b>CYN</b> </td> </tr> <tr> <td><b>TBN</b> </td> <td><b>PMN</b> </td> </tr> <tr> <td><b>MDN</b> </td> <td><b>FGN</b> </td> </tr> <tr> <td><b>PKN</b> </td> <td><b>CDN</b> </td> </tr> <tr> <td><b>OGN</b> </td> <td><b>LCN</b> </td> </tr> <tr> <td><b>LNN</b> </td> <td><b>SYN</b> </td> </tr> <tr> <td><b>LMN</b> </td> <td><b>BLN</b> </td> </tr> <tr> <td><b>EGN</b> </td> <td><b>NVN</b> </td> </tr> <tr> <td></td> <td><b>IVN</b> </td> </tr> <tr> <td></td> <td><b>CNN</b> </td> </tr> <tr> <td></td> <td><b>GHN</b> </td> </tr> <tr> <td></td> <td><b>CLN</b> </td> </tr> <tr> <td></td> <td><b>BHN</b> </td> </tr> <tr> <td></td> <td><b>SLN</b> </td> </tr> <tr> <td></td> <td><b>CNN</b> </td> </tr> <tr> <td></td> <td><b>GRN</b> </td> </tr> <tr> <td></td> <td><b>MON</b> </td> </tr> <tr> <td></td> <td><b>ESN</b> </td> </tr> </tbody> </table> <sup>12</sup> Please consult factory for more color options. <sup>13</sup> Lead time may vary.	STANDARD COLORS	PREMIUM COLORS <sup>12,13</sup>	<b>FWN</b>	<b>LVN</b>	<b>FON</b>	<b>LEN</b>	<b>ION</b>	<b>CYN</b>	<b>TBN</b>	<b>PMN</b>	<b>MDN</b>	<b>FGN</b>	<b>PKN</b>	<b>CDN</b>	<b>OGN</b>	<b>LCN</b>	<b>LNN</b>	<b>SYN</b>	<b>LMN</b>	<b>BLN</b>	<b>EGN</b>	<b>NVN</b>		<b>IVN</b>		<b>CNN</b>		<b>GHN</b>		<b>CLN</b>		<b>BHN</b>		<b>SLN</b>		<b>CNN</b>		<b>GRN</b>		<b>MON</b>		<b>ESN</b>	<b>FU120</b> - Fuse 120V <b>FU277</b> - Fuse 277V <b>CTB9</b> <sup>15</sup> - T-bar caddy clip, 9/16" <b>CTB15</b> <sup>15</sup> - T-bar caddy clip, 15/16" <b>CTG9</b> <sup>15</sup> - Tegular caddy clip, 9/16" <b>CTG15</b> <sup>15</sup> - Tegular caddy clip, 15/16" <b>CST</b> <sup>15</sup> - Screw slot caddy clip <b>NA</b> - None  <sup>14</sup> Separate codes with a "+" if more than one is specified. <sup>15</sup> Available with aircraft cable only.
STANDARD COLORS	PREMIUM COLORS <sup>12,13</sup>																																													
<b>FWN</b>	<b>LVN</b>																																													
<b>FON</b>	<b>LEN</b>																																													
<b>ION</b>	<b>CYN</b>																																													
<b>TBN</b>	<b>PMN</b>																																													
<b>MDN</b>	<b>FGN</b>																																													
<b>PKN</b>	<b>CDN</b>																																													
<b>OGN</b>	<b>LCN</b>																																													
<b>LNN</b>	<b>SYN</b>																																													
<b>LMN</b>	<b>BLN</b>																																													
<b>EGN</b>	<b>NVN</b>																																													
	<b>IVN</b>																																													
	<b>CNN</b>																																													
	<b>GHN</b>																																													
	<b>CLN</b>																																													
	<b>BHN</b>																																													
	<b>SLN</b>																																													
	<b>CNN</b>																																													
	<b>GRN</b>																																													
	<b>MON</b>																																													
	<b>ESN</b>																																													

## Accessories

Optional, order separately

WALL CONTROLLER <sup>16</sup>	
<b>DMX</b>	<b>DDI</b>
<b>WCW##FT</b> <sup>17</sup> - DMX wall controller white <b>WCB##FT</b> <sup>17</sup> - DMX wall controller black	<b>TWCW##FT</b> <sup>18</sup> - Dual 0-10V wall controller white <b>TWCB##FT</b> <sup>18</sup> - Dual 0-10V wall controller black
<sup>16</sup> Specify wire length (##) in feet. <sup>17</sup> Available with DMX only. For more information, see pages 12 to 17, or consult factory. <sup>18</sup> Available with DDI only. For more information, see page 18, or consult factory.	

# SQUERO ACOUSTIX



PENDANT

CHROMAWERX - SOLA, DUO

## Pendant Mounting Code

### Standard

For a standard mounting, please refer to the information below.

MOUNTING	
<b>ACS</b> - Aircraft cable, standard	<b>STS</b> - Stem, standard
<ul style="list-style-type: none"> <li>• Ø 5" for power canopy</li> <li>• Ø 3" for non-power canopy</li> <li>• Canopies are black for black fixtures, and white for all other fixture finishes</li> <li>• Power cord is black for black fixtures, and white for all other fixture finishes</li> <li>• Aircraft cable length is 36"</li> </ul>	<ul style="list-style-type: none"> <li>• Ø 5" for power canopy</li> <li>• Ø 5" for non-power canopy</li> <li>• Canopies are black for black fixtures, and white for all other fixture finishes</li> <li>• Stem finish is the same color as fixture</li> <li>• Stem length is 18"</li> <li>• Stem is not field adjustable</li> </ul>

### Custom

#### Aircraft Cable

For a custom mounting, specify the options in the parentheses.

Example: ACC(3NPC-72IN-W-PCB-NA)

MOUNTING					
ACC()					
	NON-POWER CANOPY SIZE	AIRCRAFT CABLE LENGTH	CANOPY FINISH	POWER CORD COLOR	OPTION
ACC	<b>3NPC</b> - Ø 3" non-power canopy <b>5NPC</b> - Ø 5" non-power canopy	<b>36IN</b> - 36" <b>72IN</b> - 72" <b>120IN</b> - 120" <b>#IN</b> <sup>1</sup> - Other lengths, specify in inches  <sup>1</sup> Maximum length is 288". For longer lengths, please consult factory.	<b>W</b> - Matte white <b>AL</b> - Aluminum <b>B</b> - Matte black <b>CF#</b> - Custom finish, specify RAL#	<b>PCW</b> - White <b>PCB</b> - Black	<b>SEM</b> <sup>2</sup> - Seismic mounting <b>SLC</b> <sup>2</sup> - Sloped ceiling for aircraft cable <b>NA</b> - None  <sup>2</sup> Not available with the Ø 3" non-power canopy size.

#### Stem

For a custom mounting, specify the options in the parentheses.

Example: STC(5NPC-36IN-W-STW-SLS)

MOUNTING					
STC()					
	NON-POWER CANOPY SIZE	STEM LENGTH	CANOPY FINISH	STEM COLOR	OPTION
STC	<b>5NPC</b> - Ø 5" non-power canopy	<b>18IN</b> - 18" <b>36IN</b> - 36" <b>#IN</b> <sup>3</sup> - Specify length in inches  <sup>3</sup> Minimum length is 6". Maximum length is 72". Stem is not field adjustable.	<b>W</b> - Matte white <b>AL</b> - Aluminum <b>B</b> - Matte black <b>CF#</b> - Custom finish, specify RAL#	<b>STW</b> - Matte white <b>STAL</b> - Aluminum <b>STB</b> - Matte black <b>STCF#</b> - Custom finish, specify RAL#	<b>SLS</b> - Sloped ceiling for stem <b>NA</b> - None



# SQUERO ACOUSTIX



PENDANT

CHROMAWERX - SOLA, DUO

## Standard Color Options



**FWN** - FROST WHITE

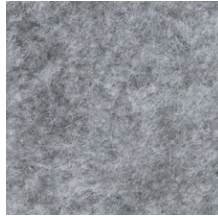

**FON** - FOG

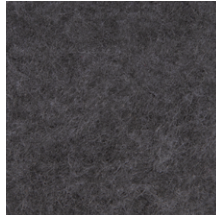

**ION** - IRON



**TBN** - TRUE BLACK



**MDN** - MIDNIGHT BLUE



**LVN** - LAVENDER



**LEN** - LATTE



**CYN** - CHERRY



**PMN** - PLUM

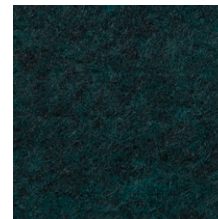

**FGN** - FOREST GREEN

## Premium Color Options\*



**PKN** - PAPRIKA



**OGN** - ORANGE



**LNN** - LEMON



**LMN** - LIME

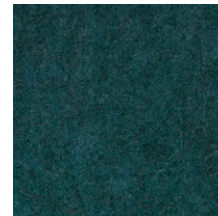

**EGN** - EVERGREEN



**CDN** - CLOUDY

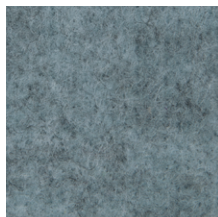

**LCN** - LICHEN



**SYN** - SKY



**BLN** - BLUEBERRY



**NVN** - NAVY



**IVN** - IVORY



**SLN** - STEEL



**CNN** - CARBON

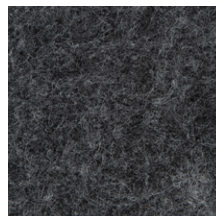

**GHN** - GRAPHITE

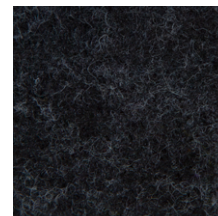

**CLN** - CHARCOAL



**BHN** - BLUSH



**CFN** - CAFÉ



**GRN** - GREIGE



**MON** - MOCHA



**ESN** - ESPRESSO

\*Please consult factory for more color options.  
\*Lead time may vary.

# SQUERO ACOUSTIX



PENDANT

CHROMAWERX - SOLA, DUO

## Dimension

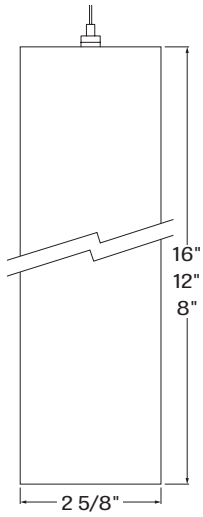

# SQUERO ACOUSTIX



PENDANT

CHROMAWERX - SOLA, DUO

## Photometrics

Values calculated based on a 4' fixture at 3500K and 80+ CRI for all optics.

### DIRECT OPTICS

### INDIRECT OPTICS

MBPL

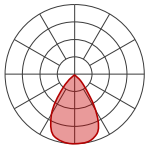

LM/FT	W/FT	LM/W
350	5.2	67
500	7.5	66
750	11.7	64

MPL

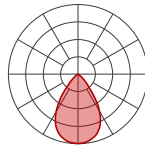

LM/FT	W/FT	LM/W
350	3.5	99
500	5.1	98
750	7.7	98
1000	10.6	95

WIO2

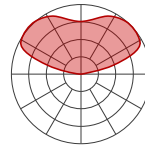

LM/FT	W/FT	LM/W
350	2.4	145
500	3.5	141
750	5.5	136
1000	7.7	130

TIO

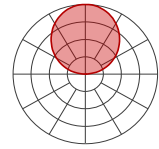

LM/FT	W/FT	LM/W
350	2.8	127
500	4.0	124
750	6.3	119
1000	8.8	114

SPL

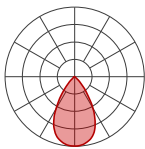

LM/FT	W/FT	LM/W
350	3.1	113
500	4.4	113
750	6.7	112
1000	9.1	109

HLO

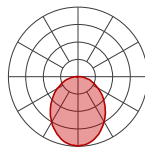

LM/FT	W/FT	LM/W
350	3.1	112
500	4.6	108
750	7.3	103
1000	10.2	98

WAI2

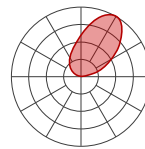

LM/FT	W/FT	LM/W
350	2.5	139
500	3.7	135
750	5.8	130

### DIRECT/INDIRECT - LPW CALCULATION

For Direct/Indirect performance values, follow the formula.

$$\frac{\left( \begin{array}{c} \text{DIRECT} \\ \text{LM/FT} \end{array} + \begin{array}{c} \text{INDIRECT} \\ \text{LM/FT} \end{array} \right)}{\left( \begin{array}{c} \text{DIRECT} \\ \text{W/FT} \end{array} + \begin{array}{c} \text{INDIRECT} \\ \text{W/FT} \end{array} \right)} = \text{LPW}$$

# SQUERO ACOUSTIX



PENDANT

CHROMAWERX - SOLA, DUO

## Acoustic Calculator

Use the Lumenwerx Acoustix Value Calculator table to determine the number of acoustic luminaires required in a space by fixture type. We have three levels of recommended sound reduction: good, better, and best. Choosing one of these options will reduce the sound accordingly. The best option indicates the best acoustic improvement. Calculations are based on a standard ceiling height of 9 feet.

Value calculator table

FIXTURE LENGTH	FIXTURE HEIGHT	Room dimensions under 300 sq ft			Room dimensions over 300 sq ft		
		GOOD 😊	BETTER 😊😊	BEST 😊😊😊	GOOD 😊	BETTER 😊😊	BEST 😊😊😊
% in reduction in reverberation time		25%	40%	50%	25%	40%	50%
1'	8"	4.75	2.25	1.5	7.25	3.75	2.5
	12"	7.25	3.5	2	11.25	5.5	3.5
	16"	9.5	4.75	3	14.5	7.25	4.75

Use the **Lumenwerx Acoustix Value Formula** to determine the number of luminaires needed in the room.

$$\frac{\text{Room square footage (sq ft)}}{\text{Fixture length (ft)} \times \text{Value}} = \text{Number of luminaires.}$$

Example: How many 4' length x 8" height luminaires are needed for a 10' x 10' room size, for a BEST (50%) acoustic:  
 $(10' \times 10') \div (4' \times 1.5) = 17$  luminaires

NOTES:

- Lumenwerx acoustic calculators were developed to act as a guide. For precise acoustic performance in a space, please consult an acoustician.



## Technical Specifications

### DIRECT OPTICS

#### Parabolic Louvers (MBPL, MPL & SPL)

Parabolic Louver Optics provide excellent shielding and a pleasing crisp visual texture. The precisely molded louvers consist of 1" deep blades and side reflectors with shielding of 50° lengthwise and 45° crosswise. The parabolic contour of the blades and side reflectors direct light into a comfortable downlight distribution with a spacing criterion of 1.1, while minimizing shadows from the LED array above each cell.

Three finishes are available: matte black, matte, and specular. Specular (SPL) provides higher efficacy, sharper cut-off, and an ultra quiet appearance at shallow viewing angles. Matte (MPL) offers a softer appearance, a wider beam spread, and gentle brightness transition at cut-off. Matte black (MBPL) offers the lowest UGR in Squero as the black parabolic louver is very quiet and glare free. The UGR is the best in class rating of under 10.



#### High-Efficiency Lambertian Optic (HLO)

The High-Efficiency Lambertian Optic (HLO) shielding of diffusing 0.075" thick acrylic with up to 88% transmission and good source obscuration is combined with matte white side reflectors to create an efficient optical chamber with uniform luminosity. Luminaire brightness is controlled by the flux-to-shielding area ratio. For visual comfort, avoid high lumen output unless Squero is installed in a high ceiling application. Spacing criteria: 1.2 (longitudinal) x 1.1 (lateral).



#### Blank (BLA)

Blank covers provide spacing – functional or rhythmic – in the direct component of a Squero Combination luminaire. Covers are sized according to the Combination design, finished to match the luminaire housing, and snap into the aperture.



### INDIRECT OPTICS

#### Widespread Indirect Optic (WIO2)

The Widespread Indirect Optic (WIO2) is a horizontal LED array with a widespread indirect micro prismatic optic that offers an impressive 160° spread. WIO2 creates an even illumination for smooth brightness on the ceiling that can achieve uniformity ratios of up to 2:1.

#### Uniformity [max/min]

Based on 18' continuous runs, in a 20' x 40' room, 10' wall height

Mounting height from ceiling	Spacing (Center to center)		
	8'	10'	12'
12"	5.5	10.0	9.0
18"	3.5	6.0	6.0
24"	2.5	4.0	4.5

#### Translucent Indirect Optic (TIO)

The Translucent Indirect Optic (TIO) is composed of a horizontal LED array that has a translucent lens to mask pixilation from the diodes. TIO has a 100° spread in the indirect that is ideal when the fixture is mounted farther away from the ceiling.

#### Widespread Asymmetric Indirect Optic (WAI2)

The Widespread Asymmetric Indirect Optic (WAI2) offers an upward grazing effect with a 45° forward throw. It softly highlights the ceiling in the up-light while distributing the required illumination of the rest of an interior space. For avoiding glare and enjoying visual comfort, WAI2 is an ideal solution.

### LIGHT SOURCE

Custom linear array of alternating color temperature mid-flux LEDs are mounted directly to the housing for optimal thermal performance. For the DUO products, a color temperature range from 6500K-2700K is achievable with color points on or below the black body curve. For the SOLA products, a color temperature range from 3500K-2200K is controlled synchronously with intensity. Color consistency between fixtures is maintained to within 3 SDCM.

All LEDs have been tested in accordance with IESNA LM-80-08 and the results have shown L80 lumen maintenance greater than 60,000 hours. Absolute product photometry is measured and presented in accordance with IESNA LM-79, unless otherwise indicated.

# SQUERO ACOUSTIX



PENDANT

CHROMAWERX - SOLA, DUO

## Chromawerx SOLA

It is a single-channel control that dims output while warming the color temperature in a pre-determined relationship. A simple analog control sends a common signal to dual output digital drivers, which are programmed to adjust a specially populated LED array to emulate the effect of dimming a filament source. Dimming range is programmable but the default option runs from 3500K at 100% of full power to 2200K at 5% of full power. CRI is maintained above 80 throughout the dimming range.

## Chromawerx DUO

It is a two-channel control. It uses an analog (0-10V) protocol for separate control of luminaire CCT and intensity or a digital (DMX, DALI and LD2) protocol for synchronous control of both warm and cool LED arrays to enable the user to set color temperature and light output. Commonly called "tunable white", Chromawerx two-channel control provides the range of cool (6500K) to warm (2700K) color that can be useful for helping to entrain circadian rhythms, stimulate alertness for improved educational and work productivity, and compensate for jet lag, among other applications. The Chromawerx drivers are programmed to limit maximum light output and power usage across all color temperatures. CRI is maintained above 80. When paired with DALI drivers (DDA/DDA8), color tuning follows a linear dimming curve.

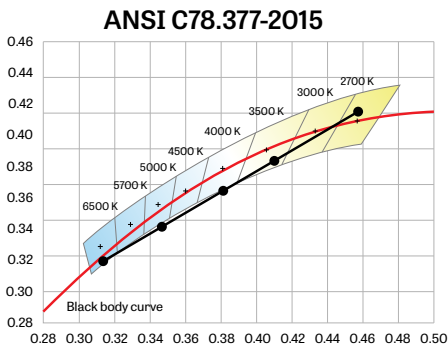

## WELL BUILDING STANDARD



**WELL for Light:** The WELL building standard focuses on light quality in several features. There are three categories that are fully attributed to the construction and features of a luminaire. In WELL V1, it's Feature 54 Circadian Lighting, Feature 55 Glare Control, and Feature 58 Color Quality. In WELL V2, it's Feature L03 Circadian Lighting, Feature L04 Glare Control, and Feature L07 Electric Light Quality.

This fixture meets Features:

- Feature 54 or L03 when DUO is selected
- Feature 55 or L04 meets WELL glare category (b-c-d)
- Feature 58 or L07 when 90+ CRI is selected

All LED drivers used at Lumenwerx are deemed to have a low risk level of flicker, of 5% or less below 90Hz operational as defined by IEEE standard 1789-2015 LED.



**WELL for Sound:** This luminaire is recommended for use as an acoustical absorption surface to limit reverberation times (RT) in a given space. This luminaire contributes to noise reduction and vibration dampening to promote focus and concentration. Reverberation needs to be calculated in each space based on the materials used.



**WELL for Mind:** This luminaire meets WELL for mind as it is a human centric luminaire offering quality light, excellent color, and smooth optics. If any of these features are incorporated in a luminaire, it can improve the ability to focus, concentrate, and persist longer on a given task. This fixture harmoniously operates in a space to assist the mind.

For more information, please contact [well@lumenwerx.com](mailto:well@lumenwerx.com)

## LUMINAIRE LENGTH

Squero Acoustix is available in standard lengths of 4' to 12'. Continuous runs are available for run lengths over 12'. Exact run length must be noted in the product code. The minimum length is 4', and can be ordered in 2' increments. All individual sections are joined together onsite using the joiner kits provided. Lumenwerx offers joiner kits that are extremely simple to work with in the field and result in a fixture that appears virtually seamless with no light leak at any connection.

# SQUERO ACOUSTIX



PENDANT

CHROMAWERX - SOLA, DUO

## ELECTRICAL

### SOLA

#### SD1

Factory-set, adjustable output current LED driver with universal (120-277 VAC) input. Using a single 0-10V control signal, the light output warms in color temperature as it dims down to 1% and 2200K. At maximum driver load, efficiency<86%, PF>0.9, THD<20%.

### DUO

#### DMX

Factory-set adjustable output current electronic driver with 120-277 VAC line input. Using DMX wall controls (optionally supplied by Lumenwerx) or an existing DMX control system, both channels of LEDs are independently adjustable. Each DMX driver can be independently addressed using the built-in RDM (Remote Device Management) in the field. Dimming down to 1% is attainable. Rated life (90% survivorship) of 50,000 hours at 50°C maximum ambient temperature. At maximum driver load, efficiency<84%, PF>0.9, THD<20%.

#### DALI

Factory-set adjustable output current electronic driver with 120-277 VAC line input. Using an existing DALI control system (supplied by others), one control channel adjusts the fixture color temperature, and the other control channel adjusts fixture brightness. With DALI Type 6, two DALI addresses are required to control both channels. With DALI Type 8, one DALI address is required to control both channels. Dimming down to 1% is attainable. Rated life (90% survivorship) of 50,000 hours at 50°C maximum ambient temperature. At maximum driver load, efficiency<84%, PF>0.9, THD<20%.

#### DD1

Factory-set adjustable output current LED driver with universal (120-277 VAC) input. Controlled via two individual 0-10V signals, one for setting light output down to a minimum of 1% and the other for adjusting the CCT (default range of 6500K-2700K). Rated life of 50,000 hours at 70°C maximum driver case temperature and 100% load conditions. Typical efficiency of 86%, PF>0.9, THD<20% at 100% load conditions.

#### LD2

Lutron DALI-2 digital drivers provide a high-performance tunable white solution with single-address digital control. Guaranteed performance and compatibility when used with Lutron DALI-2 controls.

## PoE

Depending on the PoE manufacturer selected, Lumenwerx will install the node in factory as either integral to the luminaire or as a remote module. Factory programming of the PoE node may or may not enable the following functionalities: lumen package, DUO (tunable white), QUADRO (RGBW), emergency battery backup, and sensor integration. These must be addressed and evaluated on a case-by-case basis.

## MOUNTING

Pendant fixtures can be mounted either with aircraft cable or with stem. See page 3 for details.

## FINISH

**Interior:** 95%, reflective matte powder coated white paint  
**Exterior:** Matte white, matte black, or aluminum powder coating. Custom finishes are also available.

## ACOUSTIC FINISH

Material is 100% polyester containing up to 50% of recycled plastic bottles (PET) with an ASTM E-84 Class A fire rating and is moisture resistant.

## CARE

Remove dust and debris by wiping down with a clean, dry or damp, soft, lint-free cloth, or vacuum.

## CONSTRUCTION

**Housing:** Extruded aluminum, up to 90% recycled content  
**Interior brackets:** Die-formed cold rolled steel sheet  
**Joining system:** Die-cast aluminum  
**Louvers:** Injection molded optical grade polycarbonate, up to 95% reflective  
**Light guide:** Clear PMMA laminated with microstructure film formed into optical TIR/extraction form  
**End caps:** Die-cast aluminum  
**Hanger:** Chromed griplock securely attached in end caps and/or joiners with stainless steel hardware  
**Aircraft cable suspension:** Ø 1/16" stainless steel aircraft cable  
**Stem:** Ø 1/2" diameter threaded steel tube

## WEIGHT

	Direct/Indirect	Direct
4'	21.5 lbs - 9.75 kg	12.57 lbs - 5.70 kg
6'	32.25 lbs - 14.62 kg	25.14 lbs - 11.40 kg

## ENVIRONMENT

Ambient temperature at fixture location shall not exceed 30°C/86°F. For indoor use only.



# SQUERO ACOUSTIX

PENDANT

CHROMAWERX - SOLA, DUO



## CERTIFICATION

**ETL:** Rated for indoor dry/damp locations. Conforms to UL Standard 1598 and certified to CAN/CSA Standard C22.2 No. 250.0.

## WARRANTY

Lumenwerx provides a five-year limited warranty on electrical and mechanical performance of the luminaires, including the LED boards, drivers, and auxiliary electronics. Lumenwerx will repair or replace defective luminaires or components at our discretion, provided they have been installed and operated in accordance with our specifications. Other limitations apply, please refer to the full warranty on our website.

Wall controllers are covered by the manufacturer warranty.

# SQUERO ACOUSTIX



PENDANT

CHROMAWERX - SOLA, DUO

## DUO DMX SPECIFICATION

A qualified DMX integrator is required to assure proper installation and commissioning of the DMX network. **When placing the PO, please provide the contact information of your DMX integrator.**

Please answer the following questions to help us identify your DMX network requirements.

YES

Do you require a wall controller provided by Lumenwerx?

NO

DMX control system supplied by others. Lumenwerx will supply DMX-enabled fixtures with default DMX addressing. See following pages for technical DMX informations. ✓

DMX controller supplied by Lumenwerx

**How many zones do you have?**

A zone consists of one or more luminaires behaving identically.



1 Zone



2 Zones

**How to calculate the required number of drivers:**

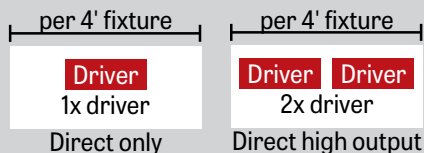

To Calculate # of drivers

1 - 4 Zones

5 or more Zones

Do you have more than 32 drivers in total?

NO

YES

Order a standard Lumenwerx wall controller.

### WALL CONTROLLER

**WCW** - wall controller white  
**WCB** - wall controller black

Add the control code at the end of your order code. Please provide a fixture layout or RCP (Reflected Ceiling Plan) showing the locations of the DMX fixtures, zones and the DMX wall controller. Refer to your DMX integrator for the installation. ✓

Subject to factory evaluation. Please contact our controls specialist at [controls@lumenwerx.com](mailto:controls@lumenwerx.com). Additional cost and equipment will be required. ✓

Subject to factory evaluation and approval. Please contact our controls specialist at [controls@lumenwerx.com](mailto:controls@lumenwerx.com). Additional cost and equipment will be required. ✓

# SQUERO ACOUSTIX

PENDANT

CHROMAWERX - SOLA, DUO



## GENERIC DMX NETWORK ARCHITECTURE

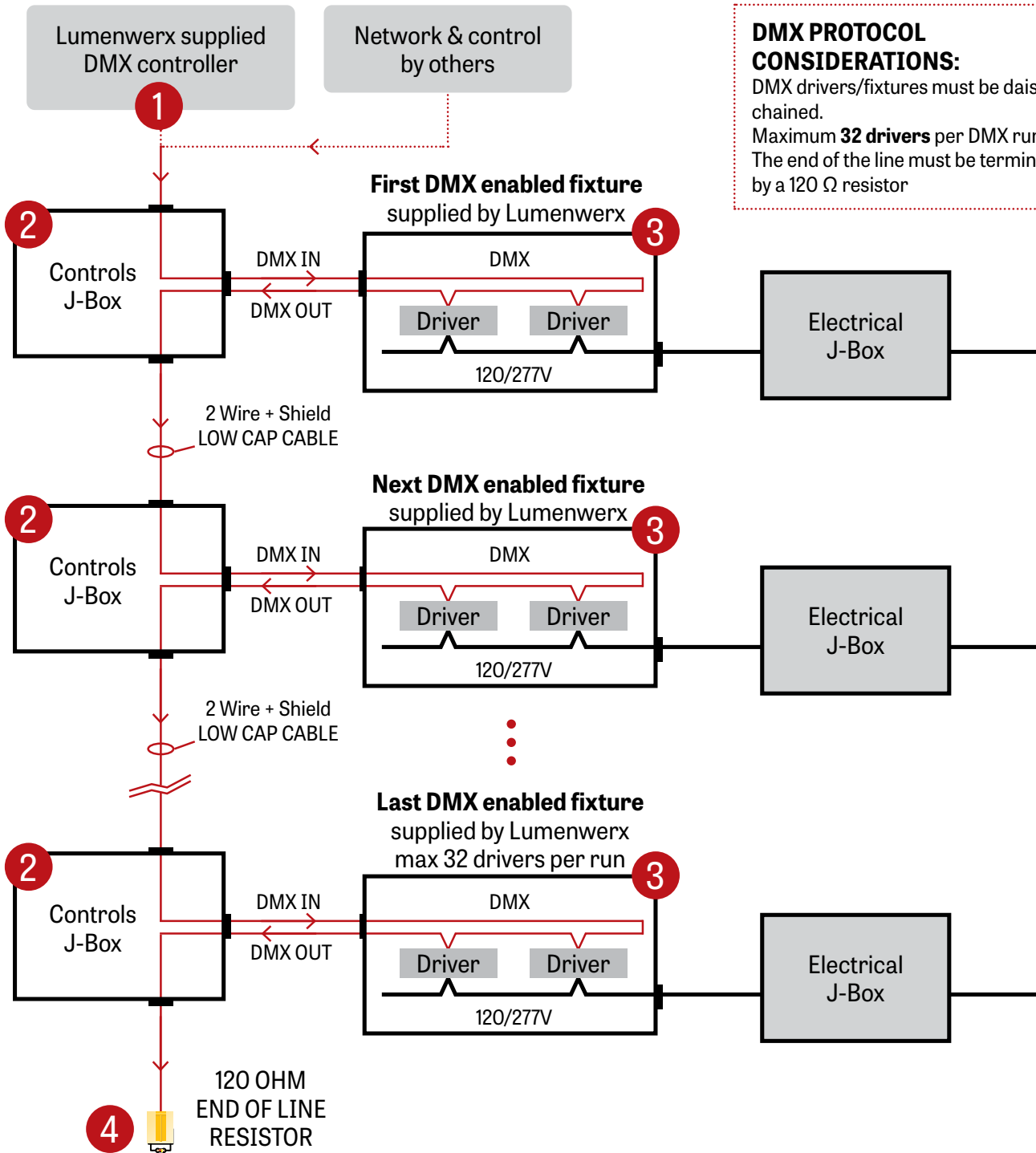

### DMX PROTOCOL CONSIDERATIONS:

DMX drivers/fixtures must be daisy chained.  
 Maximum **32 drivers** per DMX run.  
 The end of the line must be terminated by a 120 Ω resistor

# SQUERO ACOUSTIX



PENDANT

CHROMAWERX - SOLA, DUO

## 1 LUMENWERX SUPPLIED DMX CONTROLLER

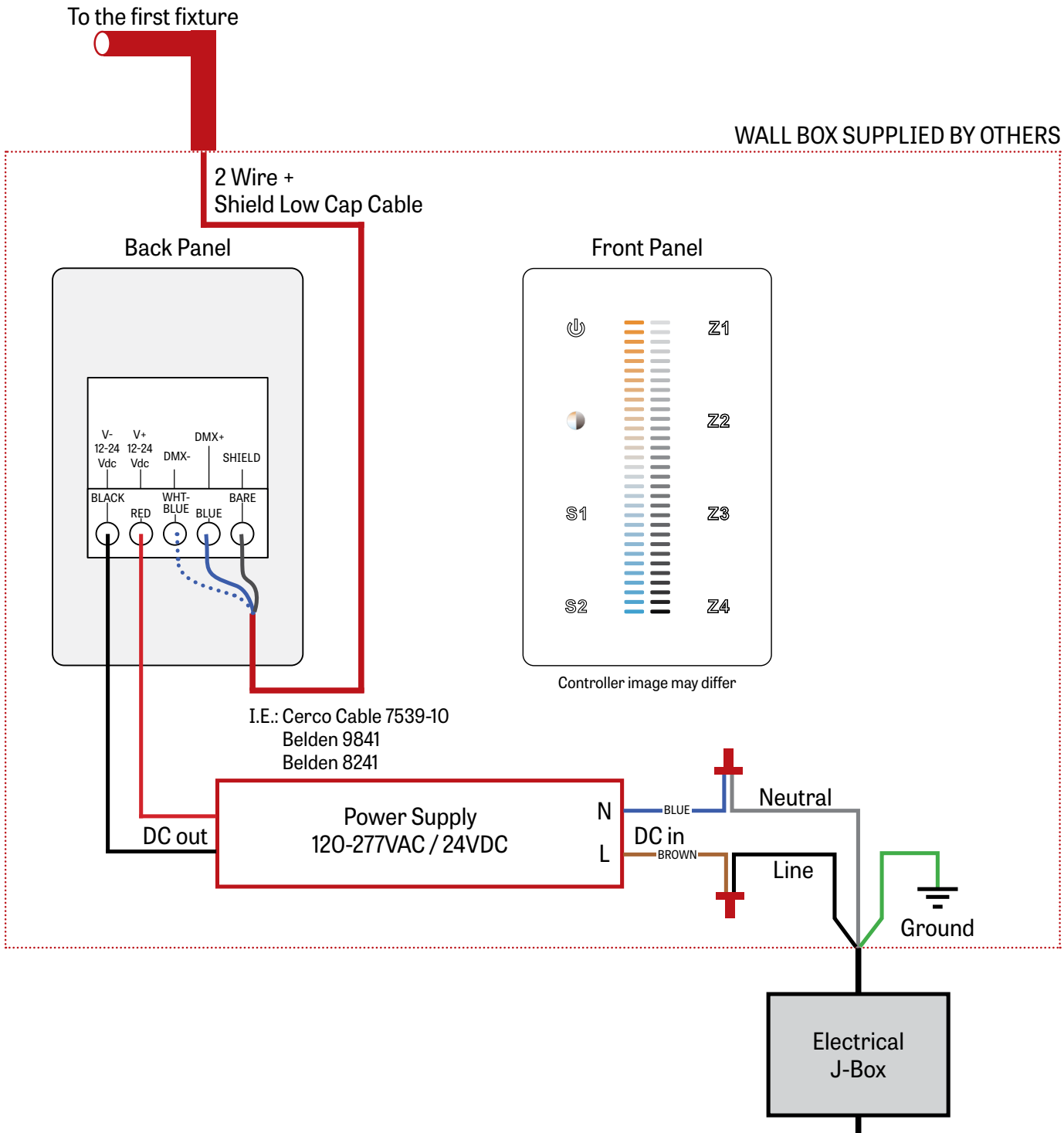

# SQUERO ACOUSTIX



PENDANT

CHROMAWERX - SOLA, DUO

## 2 J-BOX DMX DAISY CHAIN DETAIL

Low capacitance DMX Cable from Previous Fixture

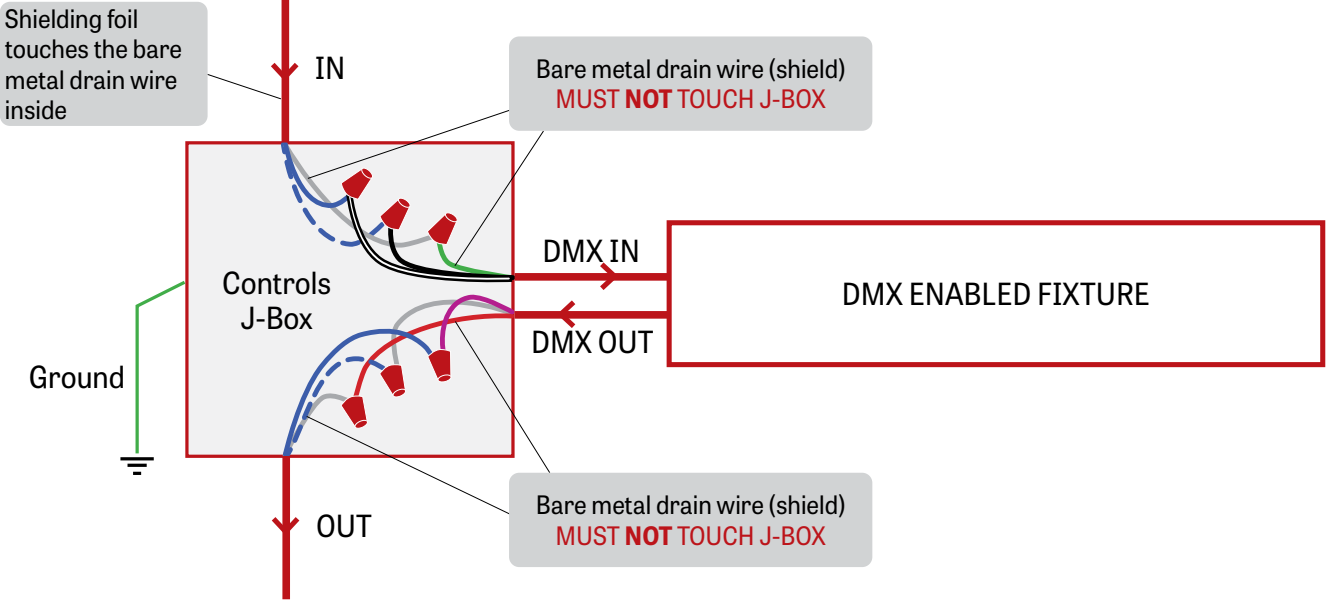

Low capacitance DMX cable to next fixture

## 3 DMX CONNECTION PENDANT & WALL

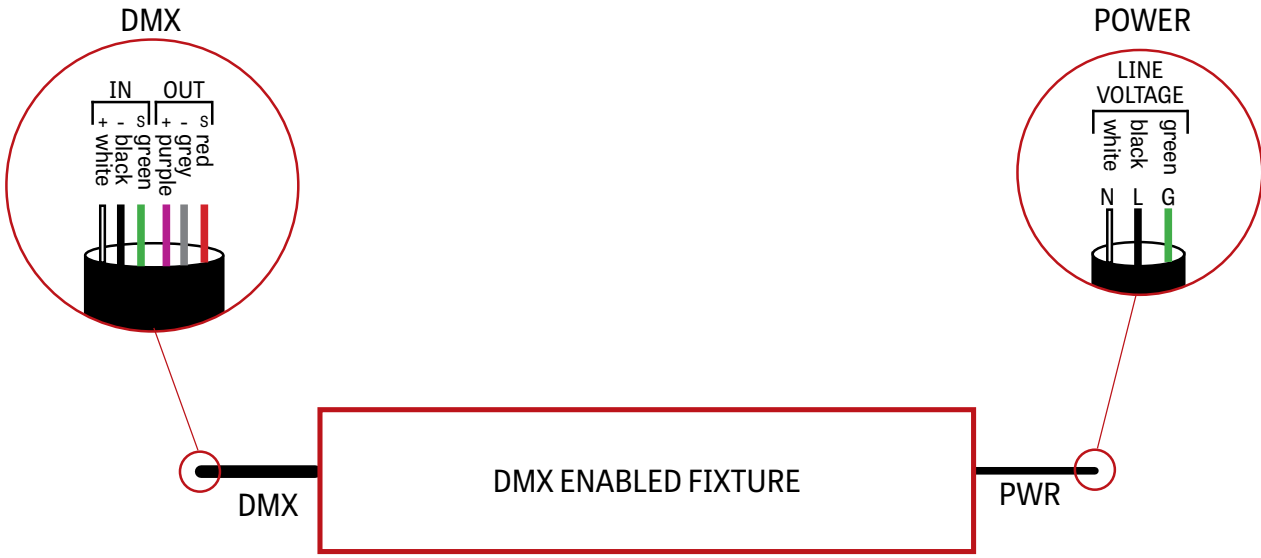

# SQUERO ACOUSTIX



PENDANT

CHROMAWERX - SOLA, DUO

## 4 DMX LAST FIXTURE DETAIL

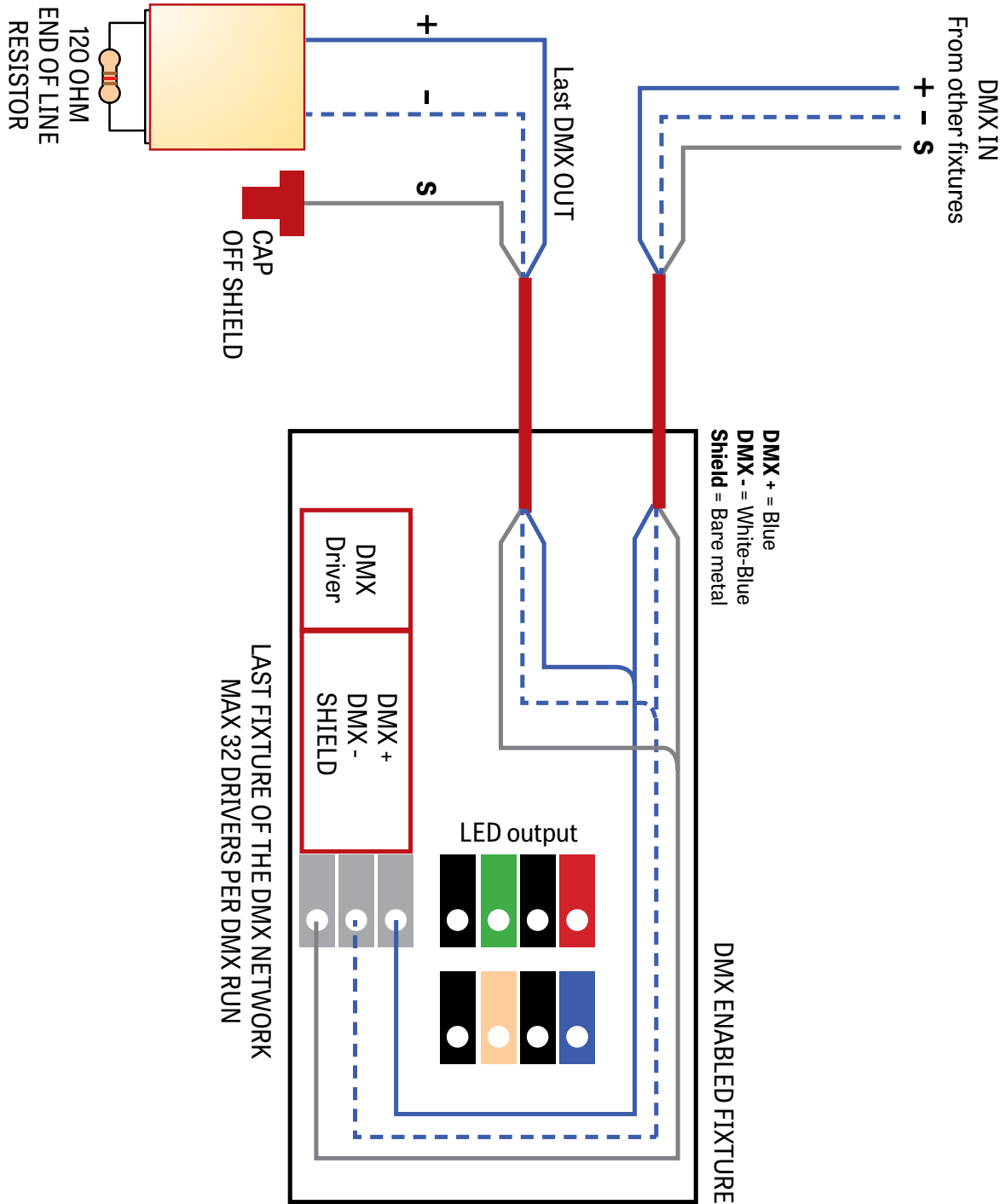

# SQUERO ACOUSTIX



PENDANT

CHROMAWERX - SOLA, DUO

## DMX WALL CONTROLLER

### DUO 1-4 ZONE

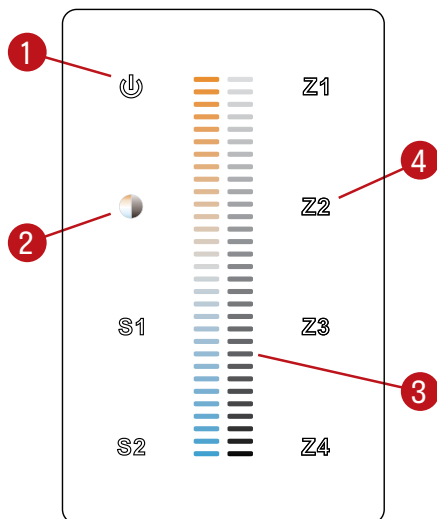

- (1) Power: Use this button to turn ON or OFF the fixture.
- (2) Brightness/CCT: Use the color/brightness toggle button to choose between color/brightness. When Blue: brightness is selected, when Yellow: color is selected.
- (3) Slider: Depending on the mode chosen in step 2, the slider will allow the user to set desired color or brightness.
- (4) Zone select: Up to 4 zones can be selected either independently or together. Once selected, the commands will be sent to the zone identified by a Blue LED.

### Default DMX Addresses:

1 Warm

2 Cool

# SQUERO ACOUSTIX



PENDANT

CHROMAWERX - SOLA, DUO

## DUAL 0-10V WALL CONTROLLER

### Front Panel

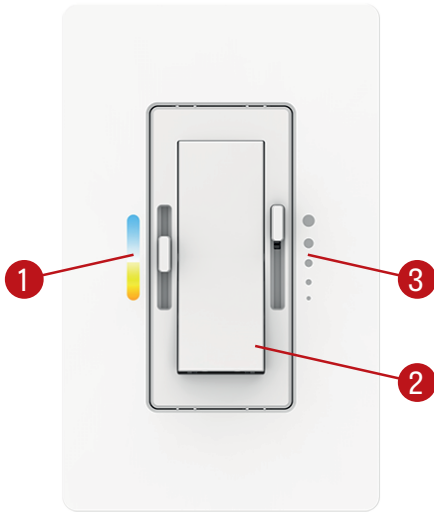

Controller image may differ

### Dimensions

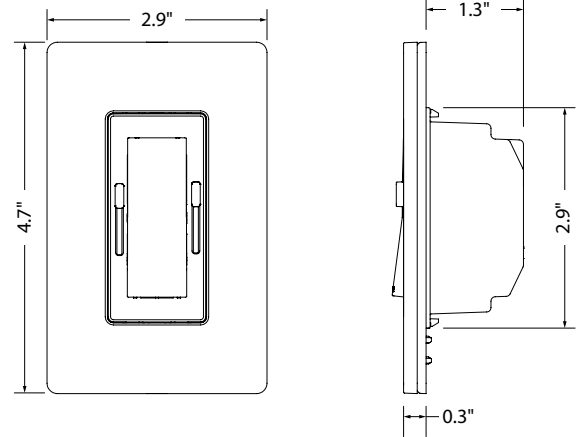

- (1) CCT control: Use this button to adjust the color temperature.
- (2) On/Off switch: Use this button to turn ON or OFF the fixture.
- (3) Dimming control: Use this button to adjust the brightness.

### Wiring Diagram

