

SQUERO HUBS

PENDANT

STATIC WHITE, BIOS



DESCRIPTION

Squero Hubs create fresh luminaire forms with distinctive angles and intersections. Hubs connect standard Squero pendant modules with 12 precise geometric alignment for 2, 3 and 4 way arrangement. With milled aluminum construction, Hubs assure rigid locking to the Squero luminaire modules and provide for cable suspension and through wiring. Concealed fastening, crisp details, and multiple color options add a touch of flair to any pattern.

SENSORS
For latest information on sensors, click [here](#).

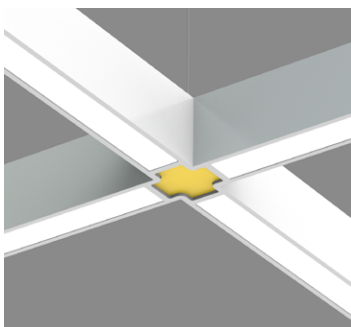
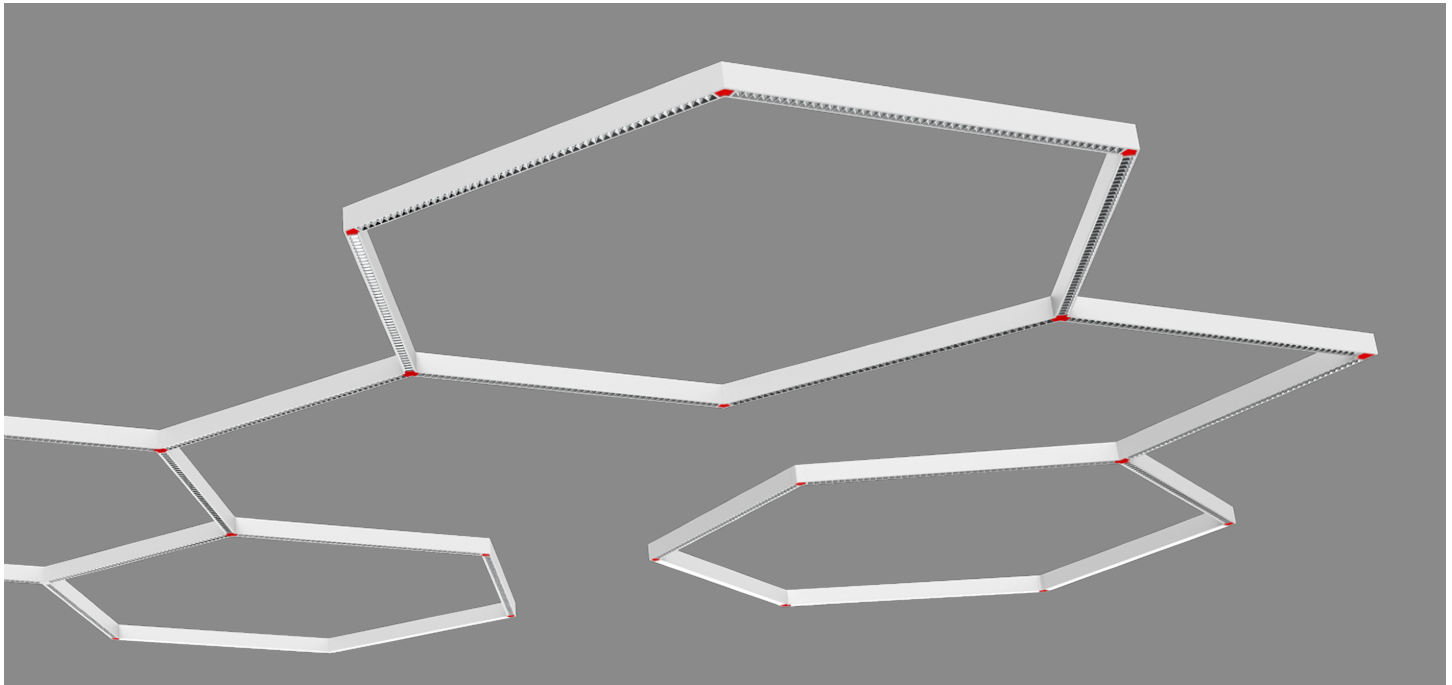

HUB ACCENT
4 WAY CONNECTION

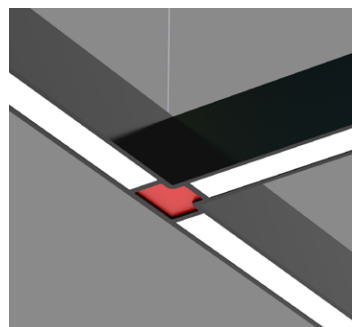

HUB ACCENT
3 WAY CONNECTION

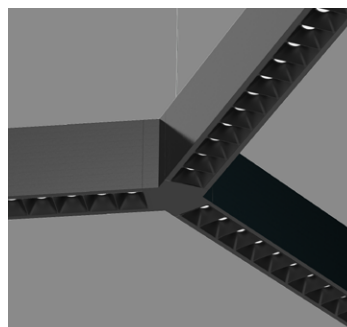

HUB FLUSH
3 WAY CONNECTION

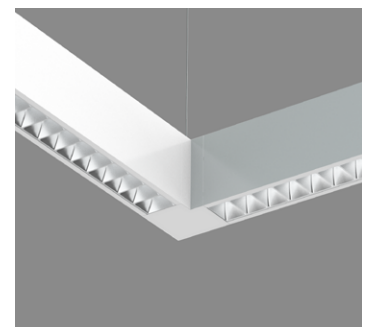

HUB FLUSH
2 WAY CONNECTION

* More Hub types are available. See page 5 for details.

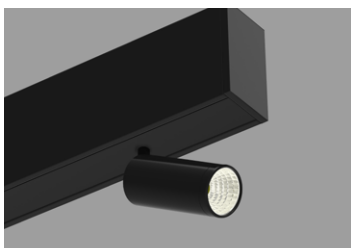

AAM
Adjustable Accent Module

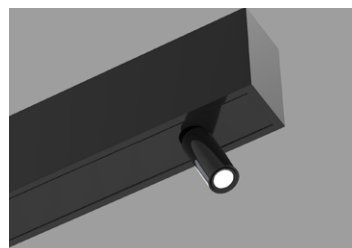

MS
Micro Spot Module

3737 Cote Vertu St-Laurent, Quebec, Canada H4R 2C9
T (514) 225-4304 F (514) 931-4862
www.lumenwerx.com



Lumenwerx reserves the right to modify product specifications without notification.
© Lumenwerx, ULC. All rights reserved.
SQUERO-HUBS-PENDANT-SPEC-REV3



SQUERO HUBS

PENDANT

STATIC WHITE, BIOS



Project: _____

Type: _____

Order Guide

Example: SQUHUBP-D-MRO18-2FT-HLO-4FT-BLA-6IN-WH-NA-SW-80CRI-350LMF-NA-27K-6FT6IN-1HFV90-NA-120V-DI-1C-NA-ACS-W-NA-NA-1AAM21(80CRI-350LM-27K-W-NA)

A drawing of your combination is required - anything from a line drawing to an architectural drawing.

LUMINAIRE ID	DISTRIBUTION	TOTAL LUMINAIRE LENGTH ¹	DIRECT OPTICS ^{3,4} Specify the total length for each required optic.	MRO COLOR	INDIRECT OPTIC Specify NA for Direct fixture
SQUHUBP					
SQUHUBP - Squero Hubs Pendant	DI - Direct/Indirect D - Direct	#FT#IN ² - Specify the total nominal length (#) in 1' and/or 1" increments Continuous runs: lengths over 12' ¹ Total luminaire length should equal the sum of all the direct optic lengths. ² Minimum section length is 2' for Direct and 4' for Direct/Indirect.	MRO18 ⁵ - 18 degree Miniature Reflector Optic MRO35 ⁵ - 35 degree Miniature Reflector Optic MRO55 ⁵ - 55 degree Miniature Reflector Optic MBPL ⁶ - Matte Black Parabolic Louver MPL ⁶ - Matte Parabolic Louver SPL ⁶ - Specular Parabolic Louver HLO - High-Efficiency Lambertian Optic BLA ⁷ - Blank	FT IN IN FT FT FT FT IN IN	WH ⁸ - White BK ⁸ - Black NA - Not applicable ⁹ Only available with MRO optics. WIO2 ⁹ - Widespread Indirect Optic TIO ¹⁰ - Translucent Indirect Optic WAI2 ¹⁰ - Widespread Asymmetric Indirect Optic NA - Not applicable ⁹ Not available with BIOSTU. ¹⁰ Not available with BIOS.

LIGHT SOURCE ¹¹	CRI	DIR. LUMEN PACK.	IND. LUMEN PACK. Specify NA for Direct fixture	COLOR TEMP.	HUB TYPE, DEGREE AND QUANTITY ²⁰ Specify quantity (#) for each required Hub	ACCENT HUB PLATE COLOR Specify NA for Flush Hubs
----------------------------	-----	------------------	---	-------------	---	---

SW - Static white BIOSS ¹² - BIOS Biological Static BIOSDY ¹² - BIOS Biological Dynamic BIOSTU ¹² - BIOS Biological Tunable ¹¹ Chromawerx SOLA and DUO also available. Consult other spec sheet. ¹² See page 8 for details.	80CRI - 80+ CRI 90CRI ¹³ - 90+ CRI ¹³ Not available with BIOS.	350LMF - Eco low output 350 lm/ft 500LMF - Low output 500 lm/ft 750LMF - Medium output 750 lm/ft 1000LMF ^{14,15} - High output 1000 lm/ft NA - Not applicable ¹⁴ Not available with MBPL optic. ¹⁵ Not available with BIOS.	350LMF - Eco low output 350 lm/ft 500LMF - Low output 500 lm/ft 750LMF - Medium output 750 lm/ft 1000LMF ^{16,17,18} - High output 1000 lm/ft NA - Not applicable ¹⁶ Not available with WAI2. ¹⁷ For Direct/Indirect, Direct must not exceed 750 lm/ft. ¹⁸ Not available with BIOS.	27K ¹⁹ - 2700K 30K - 3000K 35K - 3500K 40K - 4000K 50K ¹⁹ - 5000K ¹⁹ Not available with BIOS.	COLOR ACCENT HUBS #HCV45 - Hub "V" 45° #HCV60 - Hub "V" 60° #HCV90 - Hub "V" 90° #HCV120 - Hub "V" 120° #HCS - Hub Straight #HCT - Hub "T" #HCYR - Hub "Y" Right #HCYL - Hub "Y" Left #HCY120 - Hub "Y" 120° #HCY135 - Hub "Y" 135° #HCPL - Hub "+" #HCX - Hub "X" ²⁰ Separate codes with a "+" if more than one is specified, e.g. 1HCV90+1HCT.	FLUSH HUBS #HFV45 - Hub "V" 45° #HFV60 - Hub "V" 60° #HFV90 - Hub "V" 90° #HFV120 - Hub "V" 120° #HFS - Hub Straight #HFT - Hub "T" #HFYR - Hub "Y" Right #HFYL - Hub "Y" Left #HFY120 - Hub "Y" 120° #HFY135 - Hub "Y" 135° #HFPL - Hub "+" #HFX - Hub "X"	W - Matte white AL - Aluminum B - Matte black RAL1028 - Yellow RAL2004 - Orange RAL3020 - Red RAL4010 - Magenta RAL5002 - Blue RAL6018 - Green CF# - Custom finish, specify RAL# NA - Not applicable
---	--	---	--	--	---	--	---

VOLTAGE	DRIVER ²²	ELECTRICAL	ELECTRICAL SECTIONS (optional) ^{29,30}	MOUNTING ³⁵
---------	----------------------	------------	---	------------------------

120V - 120V 277V - 277V UNV - 120V-277V 347V ²¹ - 347V ²¹ Available with DI driver only.	D1 - 1% 0-10V ELV ²³ - ELV 120V TRI ²³ - TRIAC 120V DA ²⁴ - DALI LDE1 ²⁴ - Lutron Hi-lume 1% Eco ELD1 - eldoLED 1% ECOdrive 0-10V ELDO - eldoLED 0.1% SOLOdrive 0-10V ²² PoE (Power-over-Ethernet) compatible. Consult factory for details. ²³ Available with 120V only. ²⁴ On-site commissioning is required.	1C - 1 circuit 2C ²⁵ - 2 circuits #MC ²⁶ - Multi circuit EC - Emergency-powered fixture NL - Night light fixture DL - Daylight fixture GTD ^{27,28} - Generator transfer device fixture ²⁵ Available for Direct/Indirect only. Separate direct and indirect circuits. ²⁶ Specify total number of circuits (#), including any required for electrical section or module options. Provide drawing or layout specifications. Minimum 4' section per circuit. ²⁷ Minimum 4' fixture. ²⁸ Not available with 347V.	#EC## ³¹ - Emergency-powered section #NL## ³¹ - Night light section #DL## ³¹ - Daylight section #GTD## ^{31,32,33} - Generator transfer device section #EMB ^{33,34} - Emergency battery NA - None ²⁹ Specify with multi circuit (#MC) electrical option only. ³⁰ Provide drawing or layout specifications. Consult factory for other configurations. Default section length is 4'. ³¹ Specify quantity (#), and section length in inches (##). ³² Minimum 4' section. ³³ Not available with 347V. ³⁴ Specify quantity (#). All batteries will be on the same circuit. Each battery powers a 4' section. For Direct/Indirect, minimum 8' fixture.	ACS - Aircraft cable, standard ACC() - Aircraft cable, custom ³⁵ Standard canopies are black for black fixtures, and white for all other finishes. See page 3 for full details on standard and custom options.
--	---	---	---	---

FINISH ³⁶	CONTROL ³⁷	OPTIONS ⁴³	MODULE (optional) ^{44,45}
----------------------	-----------------------	-----------------------	------------------------------------

W - Matte white AL - Aluminum B - Matte black CF# - Custom finish, specify RAL# ³⁶ Blank and Hub finish will match fixture finish.	STANDALONE CONTROLS ^{38,39} Specify the quantity (#) of sensors per fixture. #OMS ⁴⁰ - Onboard Occupancy #OMS## ⁴¹ - Onboard Occupancy with bi-level dimming #ODS - Onboard Daylight #OCS - Onboard Occupancy & Daylight CONNECTED CONTROLS ⁴² LU - Lutron AWN - Lutron Athena Wireless Node RF Only AWNS - Lutron Athena Wireless Node Sensor ENC - Encelium WL - Cooper Wavelinx AN - Acuity nLight CA - Casambi LG - Legrand NA - None ³⁷ Standalone and connected control options cannot be combined. ³⁸ Available with DI driver and 1 circuit options only. ³⁹ Minimum 4' per zone. Provide control zone length. ⁴⁰ Fixture turns off when no occupancy. ⁴¹ Fixture dims to specified light level % (##). ⁴² Consult factory for connected controls.	FU120 - Fuse 120V FU277 - Fuse 277V CTB9 - T-bar caddy clip, 9/16" CTB15 - T-bar caddy clip, 15/16" CTG9 - Tegular caddy clip, 9/16" CTG15 - Tegular caddy clip, 15/16" CST - Screw slot caddy clip NA - None ⁴³ Separate codes with a "+" if more than one is specified.	#AAM21() - AAM 21° #AAM30() - AAM 30° #AAM36() - AAM 36° #MS25() - Micro Spot 25° #MS35() - Micro Spot 35° #MS50() - Micro Spot 50° NA - None ⁴⁴ See page 3 for ordering details. ⁴⁵ Not available with ELV/TRI driver options.
---	--	--	--



SQUERO HUBS

PENDANT

STATIC WHITE, BIOS



Module Code

For a module, specify the options in the parentheses.
The light source is static white.
CRI of module matches specification of main fixture.

Examples: 1AAM21(5W-35K-W-NA)

1MS25(5W-27K-W)

MODULE (optional)				
MODULE ^{1,2}	WATTAGE	COLOR TEMPERATURE	FINISH	OPTION
#AAM21() - AAM 21° #AAM30() - AAM 30° #AAM36() - AAM 36° ¹ Specify quantity (#). ² 6" blank per module. Blank finish will match fixture finish.	5W - 5 W, up to 364 lm output 8W - 8 W, up to 624 lm output	27K - 2700K 30K - 3000K 35K - 3500K 40K - 4000K 50K - 5000K	W - Matte white B - Matte black	HCL - Honeycomb louver NA - None

MODULE ^{1,2}	WATTAGE	COLOR TEMPERATURE	FINISH
#MS25() - Micro Spot 25° #MS35() - Micro Spot 35° #MS50() - Micro Spot 50° ¹ Specify quantity (#). ² 6" blank per module. Blank finish will match fixture finish.	5W - 5 W, up to 430 lm output	27K - 2700K 30K - 3000K 35K - 3500K 40K - 4000K 50K - 5000K	W - Matte white B - Matte black

Pendant Mounting Code

Aircraft Cable

Standard

ACS - Aircraft cable, standard

- Ø 5" for power canopy
- Ø 3" for non-power canopy
- Canopies are black for black fixtures, and white for all other fixture finishes
- Power cord is black for black fixtures, and white for all other fixture finishes
- Aircraft cable length is 36"

Custom

Example: ACC(3NPC-72IN-W-PCB-NA)

ACC() - Aircraft cable, custom

NON-POWER CANOPY SIZE	AIRCRAFT CABLE LENGTH	CANOPY FINISH	POWER CORD COLOR	OPTION
3NPC - Ø 3" non-power canopy 5NPC - Ø 5" non-power canopy	36IN - 36" 72IN - 72" 120IN - 120" #IN ¹ - Other lengths, specify in inches ¹ Maximum length is 288". For longer lengths, please consult factory.	W - Matte white AL - Aluminum B - Matte black CF# - Custom finish, specify RAL#	PCW - White PCB - Black	SEM ² - Seismic mounting SLC ² - Sloped ceiling for aircraft cable NA - None ² Not available with the Ø 3" non-power canopy size.

SQUERO HUBS

PENDANT

STATIC WHITE, BIOS



Dimensions

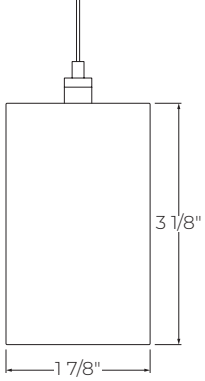

HUBS

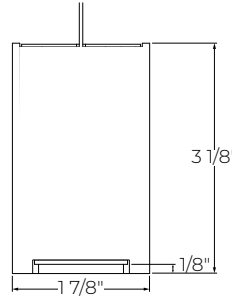

Hubs Accent

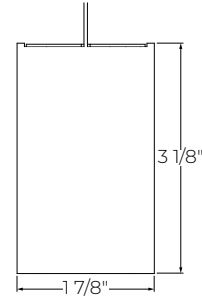

Hubs Flush

SQUERO HUBS

PENDANT

STATIC WHITE, BIOS



Hub Options

	COLOR ACCENT	FLUSH		COLOR ACCENT	FLUSH	
2 WAY CONNECTION	HCV45 - Hub "V" 45°	HFV45 - Hub "V" 45°	(A) 2 3/32" (B) 1/4" 	HCV90 - Hub "V" 90°	HFV90 - Hub "V" 90°	(A) 1" 11/32" (B) 1/8"
	HCV60 - Hub "V" 60°	HFV60 - Hub "V" 60°	(A) 1" 21/32" (B) 9/32" 	HCV120 - Hub "V" 120°	HFV120 - Hub "V" 120°	(A) 1" 1/16" (B) 3/32"
	HCS - Hub Straight	HFS - Hub Straight	(A) 1" 1/2" (B) 5/16" 			
3 WAY CONNECTION	HCYR - Hub "Y" Right	HCYL - Hub "Y" Left	HFYR - Hub "Y" Right	HFYL - Hub "Y" Left	(A) 1" 13/16" (B) 3/8" 	(A) 1" 13/16" (B) 3/8"
	HCV120 - Hub "Y" 120°	HCY135 - Hub "Y" 135°	HFY120 - Hub "Y" 120°	HFY135 - Hub "Y" 135°	(A) 1" 3/16" (B) 3/16" 	(A) 1" 21/32" (B) 1/2"
	HCT - Hub "T"	HFT - Hub "T"	(A) 1" 9/16" (B) 5/16" 			
4 WAY CONNECTION	HCPL - Hub "+"	HCX - Hub "X"	HFPL - Hub "+"	HFY - Hub "Y"	(A) 2" 1/4" (B) 2" 1/4" 	(A) 2" 1/4" (B) 2" 1/4"

SQUERO HUBS

PENDANT

STATIC WHITE, BIOS



Photometrics

Values calculated based on a 4' fixture at 3500K and 80+ CRI for all optics.

DIRECT OPTICS

MRO18

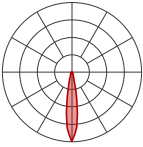

LM/FT	W/FT	LM/W
350	2.7	130
500	4.0	125
750	6.4	118
1000	9.1	110

MRO35

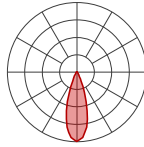

LM/FT	W/FT	LM/W
350	2.9	121
500	4.3	116
750	6.9	108
1000	9.9	101

MRO55

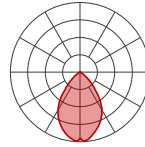

LM/FT	W/FT	LM/W
350	3.2	109
500	4.8	104
750	7.7	97
1000	11.0	91

HLO

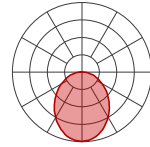

LM/FT	W/FT	LM/W
350	3.1	112
500	4.6	108
750	7.3	103
1000	10.2	98

MBPL

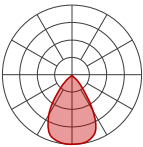

LM/FT	W/FT	LM/W
350	5.2	67
500	7.5	66
750	11.7	64

MPL

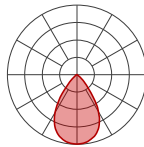

LM/FT	W/FT	LM/W
350	3.5	99
500	5.1	98
750	7.7	98
1000	10.6	95

SPL

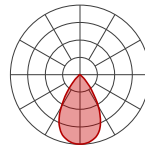

LM/FT	W/FT	LM/W
350	3.1	113
500	4.4	113
750	6.7	112
1000	9.1	109

MULTIPLIER TABLES - CCT/CRI

Use these tables to get results for different color temperatures and CRI for all Direct and Indirect photometric tables.

MRO18 / MRO35 / MRO55

CCT	WATTS		LPW	
	80+ CRI	90+ CRI	80+ CRI	90+ CRI
2700K	1.04	1.19	0.96	0.84
3000K	1.00	1.15	1.00	0.87
3500K	1.00	1.12	1.00	0.89
4000K	0.99	1.10	1.01	0.91
5000K	0.94	1.06	1.06	0.94

MBPL / MPL / SPL

CCT	WATTS		LPW	
	80+ CRI	90+ CRI	80+ CRI	90+ CRI
2700K	1.04	1.19	0.96	0.84
3000K	1.00	1.15	1.00	0.87
3500K	1.00	1.12	1.00	0.89
4000K	0.99	1.10	1.01	0.91
5000K	0.94	1.06	1.06	0.94

HLO

CCT	WATTS		LPW	
	80+ CRI	90+ CRI	80+ CRI	90+ CRI
2700K	1.05	1.27	0.95	0.79
3000K	1.02	1.23	0.98	0.81
3500K	1.00	1.19	1.00	0.84
4000K	1.00	1.19	1.00	0.84
5000K	0.96	1.12	1.04	0.89

SQUERO HUBS

PENDANT

STATIC WHITE, BIOS



Values calculated based on a 4' fixture at 3500K and 80+ CRI for all optics.

INDIRECT OPTICS

WIO2

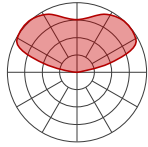

LM/FT	W/FT	LM/W
350	2.4	145
500	3.5	141
750	5.5	136
1000	7.7	130

TIO

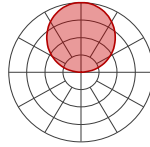

LM/FT	W/FT	LM/W
350	2.8	127
500	4.0	124
750	6.3	119
1000	8.8	114

WAI2

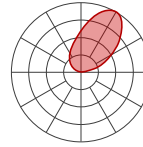

LM/FT	W/FT	LM/W
350	2.5	139
500	3.7	135
750	5.8	130

MULTIPLIER TABLES - CCT/CRI

Use these tables to get results for different color temperatures and CRI for all Direct and Indirect photometric tables.

WIO2 / TIO / WAI2

CCT	WATTS		LPW	
	80+ CRI	90+ CRI	80+ CRI	90+ CRI
2700K	1.05	1.27	0.95	0.79
3000K	1.02	1.23	0.98	0.81
3500K	1.00	1.19	1.00	0.84
4000K	1.00	1.19	1.00	0.84
5000K	0.96	1.12	1.04	0.89

DIRECT/INDIRECT - LPW CALCULATION

For Direct/Indirect performance values, follow the formula.

$$\left(\frac{\text{DIRECT LM/FT} + \text{INDIRECT LM/FT}}{\text{DIRECT W/FT} + \text{INDIRECT W/FT}} \right) = \text{LPW}$$

AAM MODULE

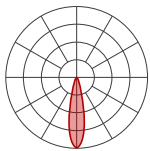

AAM 21°

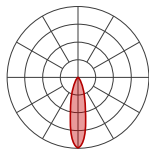

AAM 30°

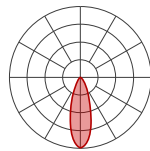

AAM 36°

DELIVERED LUMENS

Wattage	5.0									
CRI	80+					90+				
CCT	2700K	3000K	3500K	4000K	5000K	2700K	3000K	3500K	4000K	5000K
Lumen	323	340	350	357	364	265	279	289	299	312
Wattage	8.0									
CRI	80+					90+				
CCT	2700K	3000K	3500K	4000K	5000K	2700K	3000K	3500K	4000K	5000K
Lumen	553	583	600	612	624	454	478	495	513	534

MICRO SPOT MODULE

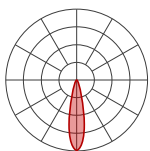

Micro Spot 25°

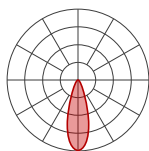

Micro Spot 35°

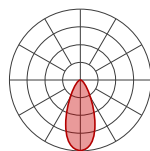

Micro Spot 50°

DELIVERED LUMENS

Wattage	5.0									
CRI	80+					90+				
CCT	2700K	3000K	3500K	4000K	5000K	2700K	3000K	3500K	4000K	5000K
Lumen	373	400	400	432	432	324	344	344	345	372

SQUERO HUBS

PENDANT

STATIC WHITE, BIOS



BIOS

Three BIOS Circadian LED solutions are offered – Biological Static, Biological Dynamic, and Biological Tunable. Use the decision tree below to identify when and where to use BIOS Wellness LED Lighting Solutions.

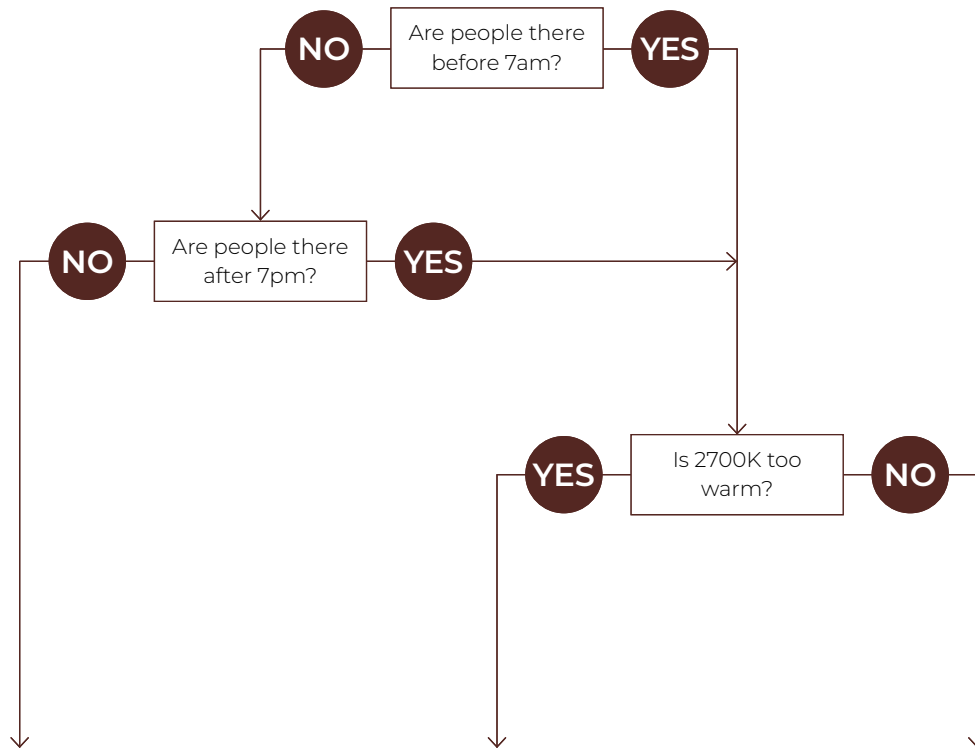

Biological Static BIOSST	Biological Dynamic BIOSDY	Biological Tunable BIOSTU
No CCT change when dimmed	500K shift when dimmed	Dims to 2700K
Daytime solution	Daytime + evening solution	Daytime + evening solution
Spaces in operation during daytime hours, between 7am and 7pm	Spaces in operation overnight, after 7pm and before 7am, and when CCT color shift in the evening is not preferred	Suitable for spaces in operation overnight, after 7pm and before 7am, and where people do not sleep (CCT color shift in the evening is preferred)
E.g. offices, medical/dental offices	E.g. hospitals	E.g. offices, shiftwork

SQUERO HUBS

PENDANT

STATIC WHITE, BIOS



Technical Specifications

DIRECT OPTICS

Miniature Reflector Optic (MRO)

Locates individual, precisely molded TIR elements over each LED emitter, and further shield the source with precise parabolic reflectors. The controlled beam is remarkably comfortable – especially in a small LED luminaire.

MRO is available in a specular black or gloss white finish and creates a distinctive visual texture.

Different TIR elements offer a choice of beam spreads: narrow (18° with SC of 0.3), medium (35° with SC of 0.6), and wide (55° with SC of 0.9). These concentrated distributions can provide effective task illumination in a variety of applications.

Each MRO module is 6" long with five optical chambers.



Parabolic Louvers (MBPL, MPL & SPL)

Parabolic Louver Optics provide excellent shielding and a pleasing crisp visual texture. The precisely molded louvers consist of 1" deep blades and side reflectors with shielding of 50° lengthwise and 45° crosswise.

The parabolic contour of the blades and side reflectors direct light into a comfortable downlight distribution with a spacing criterion of 1.1, while minimizing shadows from the LED array above each cell.

Three finishes are available: matte black, matte, and specular. Specular (SPL) provides higher efficacy, sharper cut-off, and an ultra quiet appearance at shallow viewing angles. Matte (MPL) offers a softer appearance, a wider beam spread, and gentle brightness transition at cut-off. Matte black (MBPL) offers the lowest UGR in Squero as the black parabolic louver is very quiet and glare free. The UGR is the best in class rating of under 10.



High-Efficiency Lambertian Optic (HLO)

The High-Efficiency Lambertian Optic (HLO) shielding of diffusing 0.075" thick acrylic with up to 88% transmission and good source obscuration is combined with matte white side reflectors to create an efficient optical chamber with uniform luminosity.

Luminaire brightness is controlled by the flux-to-shielding area ratio. For visual comfort, avoid high lumen output unless Squero is installed in a high ceiling application. Spacing criteria: 1.2 (longitudinal) x 1.1 (lateral).



Blank (BLA)

Blank covers provide spacing – functional or rhythmic – in the direct component of a Squero Combination luminaire. Covers are sized according to the Combination design, finished to match the luminaire housing, and snap into the aperture.



INDIRECT OPTICS

Widespread Indirect Optic (WIO2)

The Widespread Indirect Optic (WIO2) is a horizontal LED array with a widespread indirect micro prismatic optic that offers an impressive 160° spread. WIO2 creates an even illumination for smooth brightness on the ceiling that can achieve uniformity ratios of up to 2:1.

Uniformity [max/min]

Based on 18' continuous runs, in a 20' x 40' room, 10' wall height

Mounting height from ceiling	Spacing (Center to center)		
	8'	10'	12'
12"	5.5	10.0	9.0
18"	3.5	6.0	6.0
24"	2.5	4.0	4.5

Translucent Indirect Optic (TIO)

The Translucent Indirect Optic (TIO) is composed of a horizontal LED array that has a translucent lens to mask pixilation from the diodes. TIO has a 100° spread in the indirect that is ideal when the fixture is mounted farther away from the ceiling.

Widespread Asymmetric Indirect Optic (WAI2)

The Widespread Asymmetric Indirect Optic (WAI2) offers an upward grazing effect with a 45° forward throw. It softly highlights the ceiling in the up-light while distributing the required illumination of the rest of an interior space. For avoiding glare and enjoying visual comfort, WAI2 is an ideal solution.

LIGHT SOURCE

Static white

Custom linear array of high-flux LEDs mounted onto aluminum-backed circuitry with quick-connect wiring to facilitate service and optimize thermal management. Available in 2700K, 3000K, 3500K, 4000K, and 5000K with a minimum 80+ CRI and an option for 90+ CRI with elevated R9 value. Color consistency maintained to within 3 SDCM. All LEDs have been tested in accordance with IESNA LM-80-08 and the results have shown L80 lumen maintenance greater than 60,000 hours. Absolute product photometry is measured and presented in accordance with IESNA LM-79, unless otherwise indicated.

SQUERO HUBS

PENDANT

STATIC WHITE, BIOS



BIOS

BIOS SkyBlue™ Technology is designed to provide the specific circadian stimulus to improve overall sleep quality, recovery during the night, and overall feelings of well-being. The non-visual light signals that stimulate our circadian system have peak intensity in the "sky blue" region. As the diagram below illustrates, BIOS SkyBlue technology shifts the peak LED spectral intensity (490 nm) to align better with the peak response of circadian stimulus. Also note the enhanced deep-red (near 660 nm) spectrum.

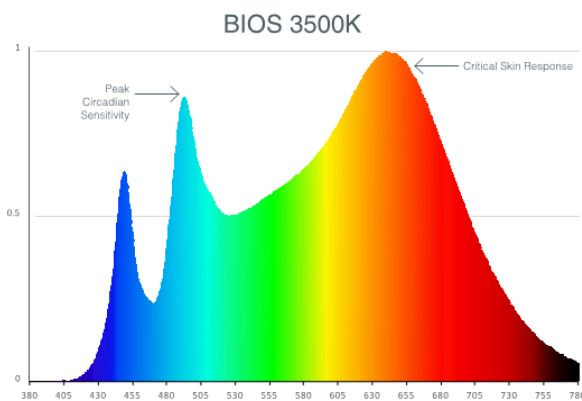

Three BIOS solutions are offered: BIOS Biological Static (BIOSST), BIOS Biological Dynamic (BIOSDY), and BIOS Biological Tunable (BIOSTU). See page 8 for details.

LUMINAIRE LENGTH

Squero Hubs can create an endless variety of forms and shapes, from geometric simplicity to organic networks. Hubs provide the vertices between Squero luminaires. Luminaire sections are available in 1' and/or 1" increments, from 2' to 12'; they can be joined to create longer runs. The minimum length is 2' for Direct fixtures, and 4' for Direct/Indirect fixtures.

HUBS

Digitally milled aluminum with draw-tight cleat of machined steel provides easy and clean installation. Cable suspension at each Hub, power feed where specified.

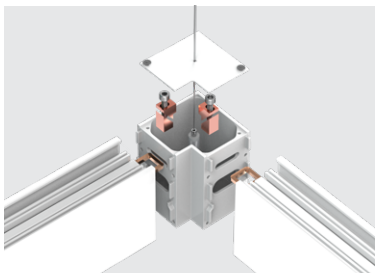

COLOR ACCENT HUBS

Optional; gloss-finished steel plate in choice of nine colors, retained by neodymium magnet, no visible fasteners, and regressed 1/8". Custom finishes are also available.

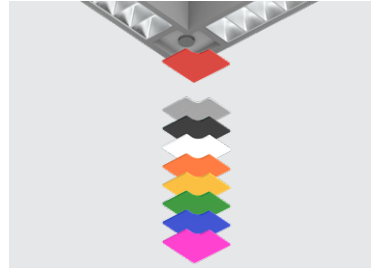

ELECTRICAL

Factory-set, adjustable output current LED driver with universal (120-277 VAC) input. Dimmable from 100% to 1% with 0-10V dimming control. Rated life (90% survivorship) of 50,000 hours at 50°C max. ambient (and 70°C max. case) temperature. At maximum driver load: Efficiency > 84%, PF > 0.9, THD < 20%. Other specifiable options include Lutron Hi-Lume 1% Eco, eldoLED 1% ECOdrive 0-10V, eldoLED 0.1% SOLOdrive 0-10V, ELV, TRIAC, and DALI protocol drivers. All of our standard 0-10V drivers are NEMA 410 compliant.

PoE

Depending on the PoE manufacturer selected, Lumenwerx will install the node in factory as either integral to the luminaire or as a remote module. Factory programming of the PoE node may or may not enable the following functionalities: lumen package, DUO (tunable white), QUADRO (RGBW), emergency battery backup, and sensor integration. These must be addressed and evaluated on a case-by-case basis.

ELECTRICAL SECTION OPTIONS

Electrical section options are available for fixtures specified as multi circuit (#MC). With MC, specify the total number of circuits (#), including any circuits required for optional electrical sections. A drawing is required to specify the layout. Please consult factory for custom configurations.

Electrical sections

Options include emergency-powered (#EC##), night light (#NL##), daylight (#DL##), and generator transfer device (#GTD##) sections. Specify the quantity (#), as well as the section length in inches (##).

Example 1: A 32' Direct fixture with two 8' emergency-powered sections on a second circuit.

Code: 2MC-2EC96

SQUERO HUBS

PENDANT

STATIC WHITE, BIOS



Example 2: A 16' Direct/Indirect fixture with separate circuits for direct and indirect, and with one 4' night light section on the direct side on a third circuit.

Code: 3MC-1NL48

Example 3: A 24' Direct fixture with one 4' generator transfer device section.

Code: 1MC-1GTD48

Battery

Each emergency battery (#EMB) powers a 4' section. All batteries will be on the same circuit. Specify the number of batteries (#) required.

Factory installed long life, high temperature, maintenance-free Lithium-Ion battery pack with self-test functionality, test switch and charge indicator. Minimum of 90 minutes operation, up to 1000 lumens per 4' (25°C) emergency lighting output and recharge time of 24 hours.

MOUNTING

Pendant fixtures can be mounted with aircraft cable. See page 3 for details

FINISH

Interior: 95%, reflective matte powder coated white paint

Exterior: Matte white, matte black, or aluminum powder coating. Custom finishes are also available.

CONTROLS

Lumenwerx offers several options for integrating occupancy and daylight harvesting controls in our luminaires.

For latest information on sensors, click [here](#).



Standalone controls

An integrated standalone sensor controls the luminaire in which it is installed. Depending on the length, more than one sensor may be necessary and may control the entire luminaire, or just a section of it. These controls operate independently. Unless otherwise agreed, sensor location, blank size, and functionality of the sensor within the luminaire are selected by Lumenwerx. See client drawings for details.

Three types are available:

OMS: An integral Passive InfraRed (PIR) sensor turns luminaires on and off automatically with field-adjustable time out period. No wall control is used. Coverage pattern for large motion has a 12' diameter with the sensor mounted 8' above the floor; for small motion, the pattern has an 8' diameter. Typically, one sensor is required for every 10' of a continuous luminaire run.

ODS: An integral, daylight harvesting sensor with closed-loop operation dims the luminaire in which it is installed in order to compensate for available daylight. The sensor measures the combination of daylight and luminaire light reflected from horizontal surfaces below the luminaire. Initial onsite calibration is required via the use of provided remote control.

OCS: Both an occupancy and a daylight sensor are installed in the luminaire.

Connected controls

With connected controls, sensors or nodes installed in the luminaire form part of a larger control system infrastructure from manufacturers such as: Lutron, Encelium, Cooper Wavelinx, Acuity nLight, Casambi, Legrand, and others. These connected controls allow for a scalable system providing features like occupancy and daylight control, manual control, scheduling and configuration of various zones and scenes. Energy reporting and system monitoring are also possible. Specific capabilities depend on the control system being used.

Lumenwerx installs the components (sensors, nodes, power packs, etc) which may be supplied to us by a third party, or procured directly by Lumenwerx, depending on the control system manufacturer.

Lumenwerx is solely responsible for the installation of specified components; the controls manufacturer is responsible for performance of the control system.

To indicate a Lumenwerx luminaire with connected controls, identify the specific onsite control system to be integrated into the luminaires using the ordering code. Due to the diversity of components, you must contact factory to assure complete compatibility with intended control system and to fully specify the luminaire.

Complete control specifications, sensor/node/power pack layout, and narrative for the control system are required for Lumenwerx to create shop drawings and submittals.

SQUERO HUBS

PENDANT

STATIC WHITE, BIOS



ADJUSTABLE ACCENT MODULE

The Adjustable Accent Module (AAM) features a $\text{Ø} 1\ 9/16'' \times 3\ 1/4''$ cylinder that rotates 360° and tilts 90° . The LED light source is coupled with TIR optics to provide beam angles of 21° , 30° , and 36° while producing up to 600 lumens. LED light source CCT options are 2700K, 3000K, 3500K, 4000K, and 5000K, available in either 80+ CRI or 90+ CRI.

The AAM module can be selected in either a white or black finish and a honeycomb louver accessory is also available. The AAM driver is mounted above the cylinder, inside the SQUERO housing and accepts universal input voltage (120-277 VAC) while providing 0-10V dimming control.

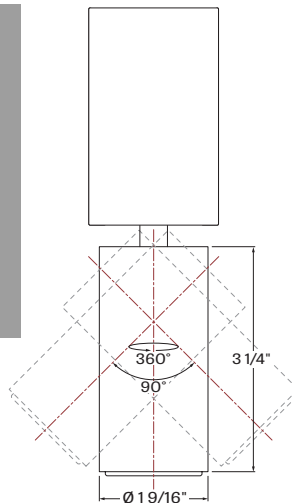
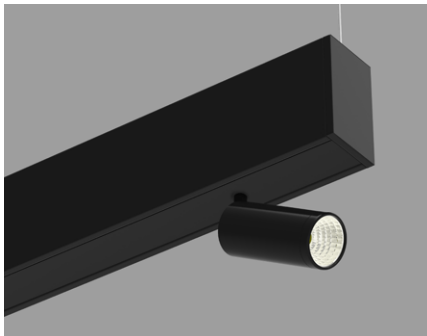

MICRO SPOT MODULE

The Micro Spot is a $\text{Ø} 7/8'' \times 1\ 5/16''$ adjustable spotlight that extends, retracts, rotates 360° , and tilts 90° . Its LED light source is coupled with a TIR refractor to provide beam angles of 25° , 35° , and 50° , while producing up to 400 lumens. LED light source CCT options are 2700K, 3000K, 3500K, 4000K, and 5000K, available in either 80+ CRI or 90+ CRI. The Micro Spot is offered in either a white or black finish. The Micro Spot driver is mounted within the luminaire housing and accepts universal input voltage (120-277 VAC) with 0-10V dimming control.

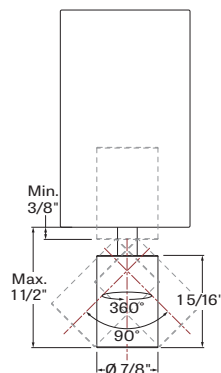
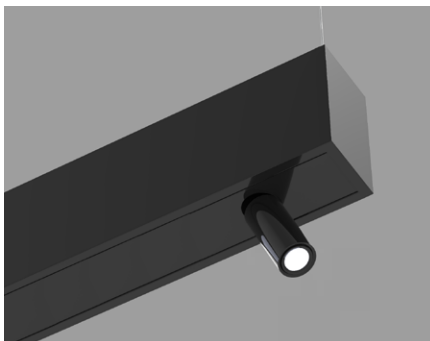

CONSTRUCTION

Housing: Extruded aluminum, up to 90% recycled content

Interior brackets: Die-formed cold rolled steel sheet

Hubs: Digitally milled from solid aluminum

Locking: Draw-tight french cleat of machined-steel with screw fastening

Top panel: Removable for access to wiring and cable; finished to match luminaire modules

Bottom panel: Milled in place, flush to the bottom of luminaire modules

Color accent plate: Gloss-finished steel plate

Louvers: Injection molded optical grade polycarbonate, up to 95% reflective

Light guide: Clear PMMA laminated with microstructure film formed into optical TIR/extraction form

End caps: Die-cast aluminum

Hanger: Chromed griplock securely attached in end caps and/or joiners with stainless steel hardware

Aircraft cable suspension: $\text{Ø} 1/16''$ stainless steel aircraft cable

CERTIFICATION

ETL: Rated for indoor dry/damp locations. Conforms to UL Standard 1598 and certified to CAN/CSA Standard C22.2 No. 250.0.

WARRANTY

Lumenwerx provides a five-year limited warranty on electrical and mechanical performance of the luminaires, including the LED boards, drivers, and auxiliary electronics. Lumenwerx will repair or replace defective luminaires or components at our discretion, provided they have been installed and operated in accordance with our specifications. Other limitations apply, please refer to the full warranty on our website.