

SQUERO HUBS

PENDANT

CHROMAWERX - SOLA, DUO



DESCRIPTION

Squero Hubs create fresh luminaire forms with distinctive angles and intersections. Hubs connect standard Squero pendant modules with 12 precise geometric alignment for 2, 3 and 4 way arrangement. With milled aluminum construction, Hubs assure rigid locking to the Squero luminaire modules and provide for cable suspension and through wiring. Concealed fastening, crisp details, and multiple color options add a touch of flair to any pattern.

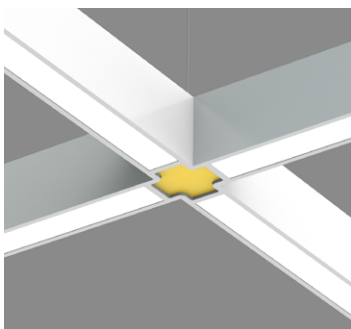
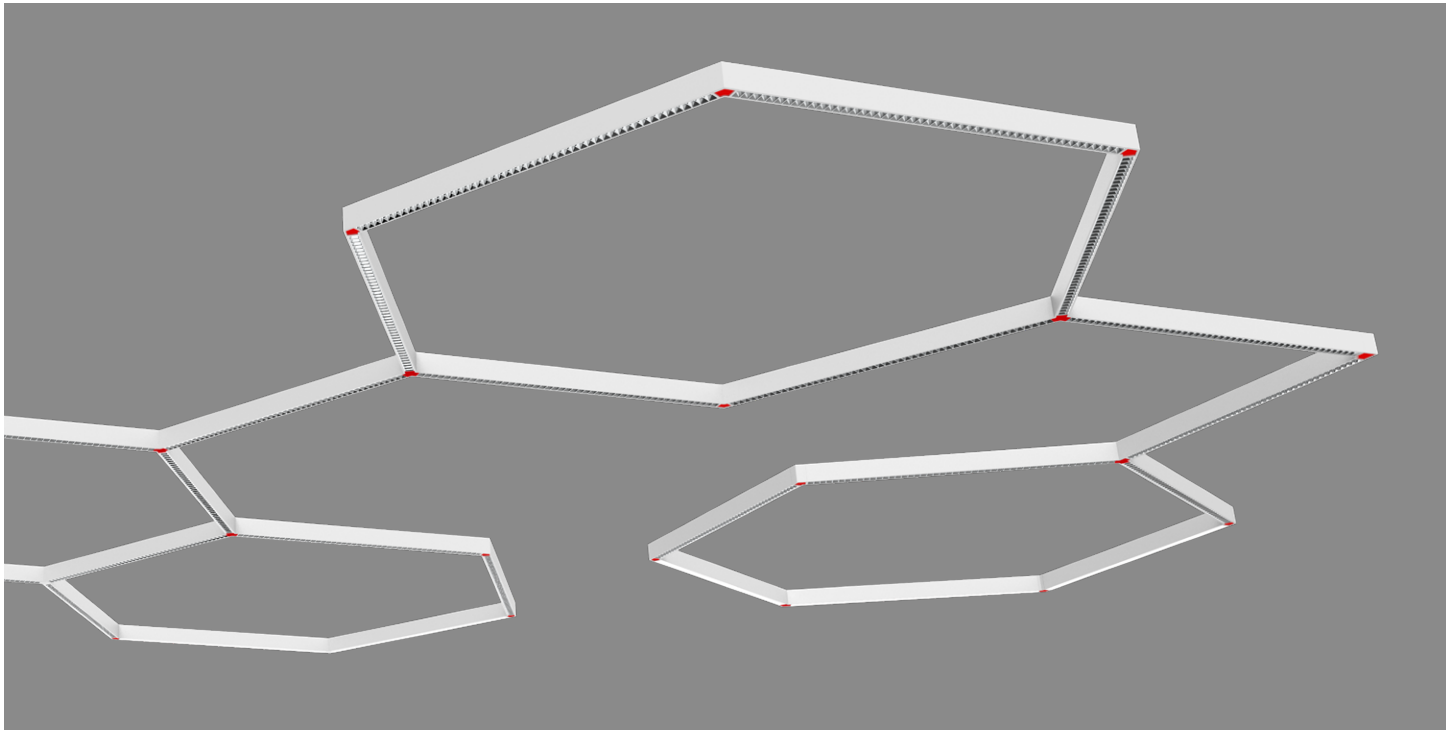

HUB ACCENT
4 WAY CONNECTION

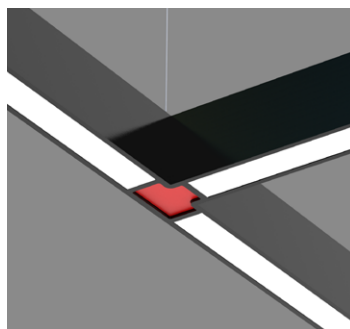

HUB ACCENT
3 WAY CONNECTION

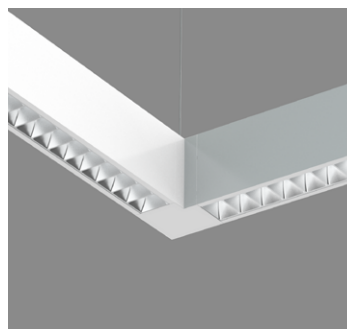

HUB FLUSH
2 WAY CONNECTION

* More Hub types are available. See page 5 for details.

SQUERO HUBS

PENDANT

CHROMAWERX - SOLA, DUO



Project: _____

Type: _____

Order Guide

Example: SQUHUBP-D-MBPL-3FT-HLO-8FT-NA-SOLA-80CRI-350LMF-NA-11FT-1HFV90-NA-120V-SD1-1C-ACS-W-NA

A drawing of your combination is required - anything from a line drawing to an architectural drawing.

LUMINAIRE ID	DISTRIBUTION	TOTAL LUMINAIRE LENGTH ¹	DIRECT OPTICS ^{3,4} Specify the total length for each required optic.	INDIRECT OPTIC Specify NA for Direct fixture
SQUHUBP				
SQUHUBP - Squero Hubs Pendant	DI - Direct/Indirect D - Direct	#FT#IN ² - Specify the total nominal length (#) in 1' and/or 1" increments Continuous runs: lengths over 12' ¹ Total luminaire length should equal the sum of all the direct optic lengths. ² Minimum section length is 3' for Direct and 4' for Direct/Indirect or DMX.	MBPL - Matte Black Parabolic Louver MPL - Matte Parabolic Louver SPL - Specular Parabolic Louver HLO - High-Efficiency Lambertian Optic BLA - Blank	FT FT FT FT IN IN
			³ Specify Parabolic Louvers in 1' increments, HLO in 4" increments, and Blank in 1" increments. ⁴ The minimum total length per louver/optic must be 3' in each section of the fixture.	WIO2 - Widespread Indirect Optic TIO - Translucent Indirect Optic WAI2 - Widespread Asymmetric Indirect Optic NA - Not applicable

LIGHT SOURCE ⁵	CRI	DIRECT LUMEN PACKAGE	INDIRECT LUMEN PACKAGE Specify NA for Direct fixture	HUB TYPE, DEGREE AND QUANTITY ⁹ Specify quantity (#) for each required Hub
SOLA - Dim-to-warm single channel control 35K to 22K DUO - Tunable white 2-channel control 65K to 27K	80CRI - 80+ CRI 90CRI - 90+ CRI	350LMF - Eco low output 350 lm/ft 500LMF - Low output 500 lm/ft 750LMF - Medium output 750 lm/ft 1000LMF ⁶ - High output 1000 lm/ft NA - Not applicable ⁶ Not available with MBPL optic.	350LMF - Eco low output 350 lm/ft 500LMF - Low output 500 lm/ft 750LMF - Medium output 750 lm/ft 1000LMF ^{7,8} - High output 1000 lm/ft NA - Not applicable ⁷ Not available with WAI2. ⁸ For Direct/Indirect, Direct must not exceed 750 lm/ft.	COLOR ACCENT HUBS #HCV45 - Hub "V" 45° #HCV60 - Hub "V" 60° #HCV90 - Hub "V" 90° #HCV120 - Hub "V" 120° #HCS - Hub Straight #HCT - Hub "T" #HCYR - Hub "Y" Right #HCYL - Hub "Y" Left #HCY120 - Hub "Y" 120° #HCY135 - Hub "Y" 135° #HCPL - Hub "+" #HCX - Hub "X" ⁹ Separate codes with a "+" if more than one is specified, e.g. 1HCV90+1HCT.
⁵ Static white and BIOS also available. Consult other spec sheet.				FLUSH HUBS #HFV45 - Hub "V" 45° #HFV60 - Hub "V" 60° #HFV90 - Hub "V" 90° #HFV120 - Hub "V" 120° #HFS - Hub Straight #HFT - Hub "T" #HFYR - Hub "Y" Right #HFYL - Hub "Y" Left #HFY120 - Hub "Y" 120° #HFY135 - Hub "Y" 135° #HFPL - Hub "+" #HFX - Hub "X"

ACCENT HUB PLATE COLOR Specify NA for Flush Hubs	VOLTAGE	DRIVER ¹⁰	ELECTRICAL	MOUNTING ¹³	FINISH ¹⁴	OPTIONS ¹⁵
W - Matte white AL - Aluminum B - Matte black RAL1028 - Yellow RAL2004 - Orange RAL3020 - Red RAL4010 - Magenta RAL5002 - Blue RAL6018 - Green CF# - Custom finish, specify RAL# NA - Not applicable	120V - 120V 277VV - 277V UNV - 120V-277V	SOLA SD1 - Single 0-10V input DUO DMX ^{11,12} - DMX DDA ¹² - DALI DT6 DDA8 ¹² - DALI DT8 DD1 - Dual 0-10V input for CCT/intensity LD2 ¹² - Lutron DALI-2 digital ¹⁰ PoE (Power-over-Ethernet) compatible. Consult factory for details. ¹¹ For more information, see pages 10 to 15. ¹² On-site commissioning is required.	1C	ACS - Aircraft cable, standard ACC() - Aircraft cable, custom ¹³ Standard canopies are black for black fixtures, and white for all other finishes. See page 3 for full details on standard and custom options.	W - Matte white AL - Aluminum B - Matte black CF# - Custom finish, specify RAL# ¹⁴ Blank and Hub finish will match fixture finish.	FU120 - Fuse 120V FU277 - Fuse 277V CTB9 - T-bar caddy clip, 9/16" CTB15 - T-bar caddy clip, 15/16" CTC9 - Tegular caddy clip, 9/16" CTG15 - Tegular caddy clip, 15/16" CST - Screw slot caddy clip NA - None ¹⁵ Separate codes with a "+" if more than one is specified.

Accessories

Optional, order separately

WALL CONTROLLER ¹⁶	
DMX	DD1
WCW##FT ¹⁷ - DMX wall controller white WCB##FT ¹⁷ - DMX wall controller black	TWCW##FT ¹⁸ - Dual 0-10V wall controller white TWCB##FT ¹⁸ - Dual 0-10V wall controller black
¹⁶ Specify wire length (##) in feet. ¹⁷ Available with DMX only. For more information, see pages 10 to 15, or consult factory. ¹⁸ Available with DD1 only. For more information, see page 16, or consult factory.	

3737 Cote Vertu St-Laurent, Quebec, Canada H4R 2C9
T (514) 225-4304 F (514) 931-4862
www.lumenwerx.com



Lumenwerx reserves the right to modify product specifications without notification.
© Lumenwerx, ULC. All rights reserved.
SQUERO-HUBS-PENDANT-TW-SPEC-REV2



April 23, 2025

SQUERO HUBS

PENDANT

CHROMAWERX - SOLA, DUO



Pendant Mounting Code

Standard

For a standard mounting, please refer to the information below.

MOUNTING

ACS - Aircraft cable, standard

- Ø 5" for power canopy
- Ø 3" for non-power canopy
- Canopies are black for black fixtures, and white for all other fixture finishes
- Power cord is black for black fixtures, and white for all other fixture finishes
- Aircraft cable length is 36"

Custom

Aircraft Cable

For a custom mounting, specify the options in the parentheses.

Example: ACC(3NPC-72IN-W-PCB-NA)

MOUNTING

ACC()

	NON-POWER CANOPY SIZE	AIRCRAFT CABLE LENGTH	CANOPY FINISH	POWER CORD COLOR	OPTION
ACC	3NPC - Ø 3" non-power canopy 5NPC - Ø 5" non-power canopy	36IN - 36" 72IN - 72" 120IN - 120" #IN ¹ - Other lengths, specify in inches ¹ Maximum length is 288". For longer lengths, please consult factory.	W - Matte white AL - Aluminum B - Matte black CF# - Custom finish, specify RAL#	PCW - White PCB - Black	SEM ² - Seismic mounting SLC ² - Sloped ceiling for aircraft cable NA - None ² Not available with the Ø 3" non-power canopy size.

SQUERO HUBS

PENDANT

CHROMAWERX - SOLA, DUO



Dimensions

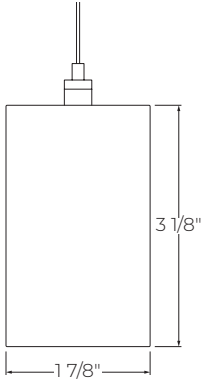

HUBS

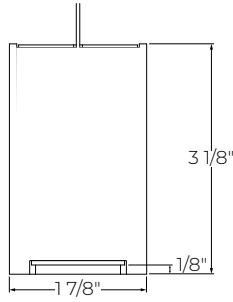

Hubs Accent

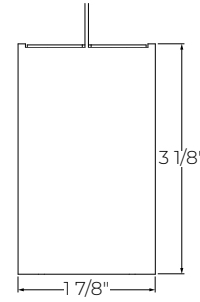

Hubs Flush

SQUERO HUBS

PENDANT

CHROMAWERX - SOLA, DUO



Hub Options

COLOR ACCENT		FLUSH		
HCV45 - Hub "V" 45°	HFV45 - Hub "V" 45°	(A) 2 3/32" (B) 1/4"		
HCV60 - Hub "V" 60°	HFV60 - Hub "V" 60°	(A) 1" 21/32" (B) 9/32"		
HCS - Hub Straight	HFS - Hub Straight	(A) 1" 1/2" (B) 5/16"		
2 WAY CONNECTION				

HCYR - Hub "Y" Right	HFYR - Hub "Y" Right	(A) 1" 13/16" (B) 3/8"		
HCYL - Hub "Y" Left	HFYL - Hub "Y" Left	(A) 1" 13/16" (B) 3/8"		
HCV120 - Hub "Y" 120°	HFV120 - Hub "Y" 120°	(A) 1" 3/16" (B) 3/16"		
HCY135 - Hub "Y" 135°	HFY135 - Hub "Y" 135°	(A) 1" 21/32" (B) 1/2"		
HCT - Hub "T"	HFT - Hub "T"	(A) 1" 9/16" (B) 5/16"		
3 WAY CONNECTION				

HCPL - Hub "+"	HFPL - Hub "+"	(A) 1" 9/16" (B) 9/16"		
HCCX - Hub "X"	HFCX - Hub "X"	(A) 2" 1/4" (B) 2" 1/4"		
4 WAY CONNECTION				

SQUERO HUBS

PENDANT

CHROMAWERX - SOLA, DUO



Photometrics

Values calculated based on a 4' fixture at 3500K and 80+ CRI for all optics.

DIRECT OPTICS

MBPL

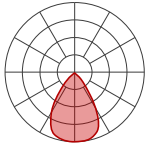

LM/FT	W/FT	LM/W
350	5.2	67
500	7.5	66
750	11.7	64

MPL

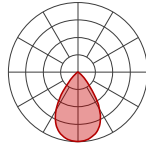

LM/FT	W/FT	LM/W
350	3.5	99
500	5.1	98
750	7.7	98
1000	10.6	95

INDIRECT OPTICS

WIO2

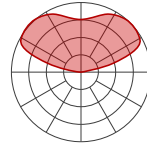

LM/FT	W/FT	LM/W
350	2.4	145
500	3.5	141
750	5.5	136
1000	7.7	130

TIO

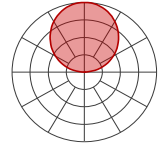

LM/FT	W/FT	LM/W
350	2.8	127
500	4.0	124
750	6.3	119
1000	8.8	114

SPL

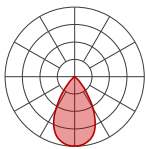

LM/FT	W/FT	LM/W
350	3.1	113
500	4.4	113
750	6.7	112
1000	9.1	109

HLO

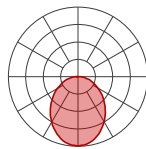

LM/FT	W/FT	LM/W
350	3.1	112
500	4.6	108
750	7.3	103
1000	10.2	98

WAI2

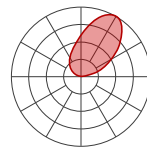

LM/FT	W/FT	LM/W
350	2.5	139
500	3.7	135
750	5.8	130

DIRECT/INDIRECT - LPW CALCULATION

For Direct/Indirect performance values, follow the formula.

$$\frac{\left(\begin{array}{c} \text{DIRECT} \\ \text{LM/FT} \end{array} + \begin{array}{c} \text{INDIRECT} \\ \text{LM/FT} \end{array} \right)}{\left(\begin{array}{c} \text{DIRECT} \\ \text{W/FT} \end{array} + \begin{array}{c} \text{INDIRECT} \\ \text{W/FT} \end{array} \right)} = \text{LPW}$$

SQUERO HUBS

PENDANT

CHROMAWERX - SOLA, DUO



Technical Specifications

DIRECT OPTICS

Parabolic Louvers (MBPL, MPL & SPL)

Parabolic Louver Optics provide excellent shielding and a pleasing crisp visual texture. The precisely molded louvers consist of 1" deep blades and side reflectors with shielding of 50° lengthwise and 45° crosswise.

The parabolic contour of the blades and side reflectors direct light into a comfortable downlight distribution with a spacing criterion of 1.1, while minimizing shadows from the LED array above each cell.

Three finishes are available: matte black, matte, and specular. Specular (SPL) provides higher efficacy, sharper cut-off, and an ultra quiet appearance at shallow viewing angles. Matte (MPL) offers a softer appearance, a wider beam spread, and gentle brightness transition at cut-off. Matte black (MBPL) offers the lowest UGR in Squero as the black parabolic louver is very quiet and glare free. The UGR is the best in class rating of under 10.



High-Efficiency Lambertian Optic (HLO)

The High-Efficiency Lambertian Optic (HLO) shielding of diffusing 0.075" thick acrylic with up to 88% transmission and good source obscuration is combined with matte white side reflectors to create an efficient optical chamber with uniform luminosity.

Luminaire brightness is controlled by the flux-to-shielding area ratio. For visual comfort, avoid high lumen output unless Squero is installed in a high ceiling application. Spacing criteria: 1.2 (longitudinal) x 1.1 (lateral).



Blank (BLA)

Blank covers provide spacing – functional or rhythmic – in the direct component of a Squero Combination luminaire. Covers are sized according to the Combination design, finished to match the luminaire housing, and snap into the aperture.



INDIRECT OPTICS

Widespread Indirect Optic (WIO2)

The Widespread Indirect Optic (WIO2) is a horizontal LED array with a widespread indirect micro prismatic optic that offers an impressive 160° spread. WIO2 creates an even illumination for smooth brightness on the ceiling that can achieve uniformity ratios of up to 2:1.

Uniformity [max/min]

Based on 18' continuous runs, in a 20' x 40' room, 10' wall height

Mounting height from ceiling	Spacing (Center to center)		
	8'	10'	12'
12"	5.5	10.0	9.0
18"	3.5	6.0	6.0
24"	2.5	4.0	4.5

Translucent Indirect Optic (TIO)

The Translucent Indirect Optic (TIO) is composed of a horizontal LED array that has a translucent lens to mask pixilation from the diodes. TIO has a 100° spread in the indirect that is ideal when the fixture is mounted farther away from the ceiling.

Widespread Asymmetric Indirect Optic (WAI2)

The Widespread Asymmetric Indirect Optic (WAI2) offers an upward grazing effect with a 45° forward throw. It softly highlights the ceiling in the up-light while distributing the required illumination of the rest of an interior space. For avoiding glare and enjoying visual comfort, WAI2 is an ideal solution.

LIGHT SOURCE

Custom linear array of alternating color temperature mid-flux LEDs are mounted directly to the housing for optimal thermal performance. For the DUO products, a color temperature range from 6500K-2700K is achievable with color points on or below the black body curve. For the SOLA products, a color temperature range from 3500K-2200K is controlled synchronously with intensity. Color consistency between fixtures is maintained to within 3 SDCM.

All LEDs have been tested in accordance with IESNA LM-80-08 and the results have shown L80 lumen maintenance greater than 60,000 hours. Absolute product photometry is measured and presented in accordance with IESNA LM-79, unless otherwise indicated.

SQUERO HUBS

PENDANT

CHROMAWERX - SOLA, DUO



Chromawerx SOLA

It is a single-channel control that dims output while warming the color temperature in a pre-determined relationship. A simple analog control sends a common signal to dual output digital drivers, which are programmed to adjust a specially populated LED array to emulate the effect of dimming a filament source. Dimming range is programmable but the default option runs from 3500K at 100% of full power to 2200K at 5% of full power. CRI is maintained above 80 throughout the dimming range.

Chromawerx DUO

It is a two-channel control. It uses an analog (0-10V) protocol for separate control of luminaire CCT and intensity or a digital (DMX, DALI and LD2) protocol for synchronous control of both warm and cool LED arrays to enable the user to set color temperature and light output. Commonly called "tunable white", Chromawerx two-channel control provides the range of cool (6500K) to warm (2700K) color that can be useful for helping to entrain circadian rhythms, stimulate alertness for improved educational and work productivity, and compensate for jet lag, among other applications. The Chromawerx drivers are programmed to limit maximum light output and power usage across all color temperatures. CRI is maintained above 80. When paired with DALI drivers (DDA/DDA8), color tuning follows a linear dimming curve.

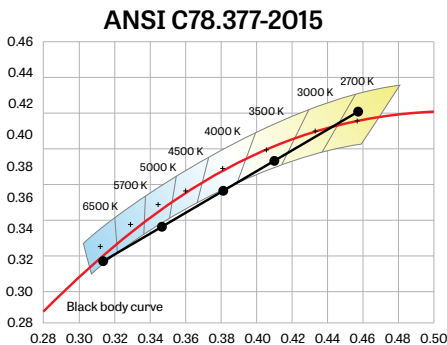

LUMINAIRE LENGTH

Squero Hubs can create an endless variety of forms and shapes, from geometric simplicity to organic networks. Hubs provide the vertices between Squero luminaires. Luminaire sections are available in 1' and/or 1" increments, from 3' to 12'; they can be joined to create longer runs. The minimum length is 3' for Direct fixtures, and 4' for Direct/Indirect fixtures or DMX.

HUBS

Digitally milled aluminum with draw-tight cleat of machined steel provides easy and clean installation. Cable suspension at each Hub, power feed where specified.

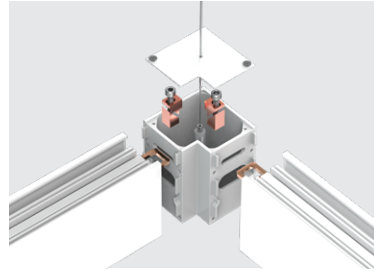

COLOR ACCENT HUBS

Optional; gloss-finished steel plate in choice of nine colors, retained by neodymium magnet, no visible fasteners, and regressed 1/8". Custom finishes are also available.

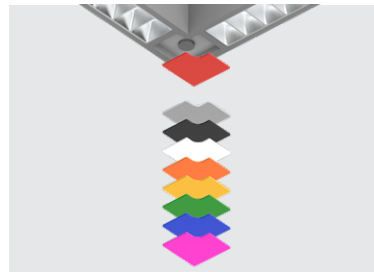

ELECTRICAL

SOLA

SDI

Factory-set, adjustable output current LED driver with universal (120-277 VAC) input. Using a single 0-10V control signal, the light output warms in color temperature as it dims down to 1% and 2200K. At maximum driver load, efficiency<86%, PF>0.9, THD<20%.

DUO

DMX

Factory-set adjustable output current electronic driver with 120-277 VAC line input. Using DMX wall controls (optionally supplied by Lumenwerx) or an existing DMX control system, both channels of LEDs are independently adjustable. Each DMX driver can be independently addressed using the built-in RDM (Remote Device Management) in the field. Dimming down to 1% is attainable. Rated life (90% survivorship) of 50,000 hours at 50°C maximum ambient temperature. At maximum driver load, efficiency<84%, PF>0.9, THD<20%.

SQUERO HUBS

PENDANT

CHROMAWERX - SOLA, DUO



DALI

Factory-set adjustable output current electronic driver with 120-277 VAC line input. Using an existing DALI control system (supplied by others), one control channel adjusts the fixture color temperature, and the other control channel adjusts fixture brightness. With DALI Type 6, two DALI addresses are required to control both channels. With DALI Type 8, one DALI address is required to control both channels. Dimming down to 1% is attainable. Rated life (90% survivorship) of 50,000 hours at 50°C maximum ambient temperature. At maximum driver load, efficiency < 84%, PF > 0.9, THD < 20%.

DD1

Factory-set adjustable output current LED driver with universal (120-277 VAC) input. Controlled via two individual 0-10V signals, one for setting light output down to a minimum of 1% and the other for adjusting the CCT (default range of 6500K-2700K). Rated life of 50,000 hours at 70°C maximum driver case temperature and 100% load conditions. Typical efficiency of 86%, PF > 0.9, THD < 20% at 100% load conditions.

LD2

Lutron DALI-2 digital drivers provide a high-performance tunable white solution with single-address digital control. Guaranteed performance and compatibility when used with Lutron DALI-2 controls.

PoE

Depending on the PoE manufacturer selected, Lumenwerx will install the node in factory as either integral to the luminaire or as a remote module. Factory programming of the PoE node may or may not enable the following functionalities: lumen package, DUO (tunable white), QUADRO (RGBW), emergency battery backup, and sensor integration. These must be addressed and evaluated on a case-by-case basis.

MOUNTING

Pendant fixtures can be mounted with aircraft cable. See page 3 for details.

FINISH

Interior: 95%, reflective matte powder coated white paint

Exterior: Matte white, matte black, or aluminum powder coating. Custom finishes are also available.

CONSTRUCTION

Housing: Extruded aluminum, up to 90% recycled content

Interior brackets: Die-formed cold rolled steel sheet

Hubs: Digitally milled from solid aluminum

Locking: Draw-tight french cleat of machined-steel with screw fastening

Top panel: Removable for access to wiring and cable; finished to match luminaire modules

Bottom panel: Milled in place, flush to the bottom of luminaire modules

Color accent plate: Gloss-finished steel plate

Louvers: Injection molded optical grade polycarbonate, up to 95% reflective

Light guide: Clear PMMA laminated with microstructure film formed into optical TIR/extraction form

End caps: Die-cast aluminum

Hanger: Chromed griplock securely attached in end caps and/or joiners with stainless steel hardware

Aircraft cable suspension: Ø 1/16" stainless steel aircraft cable

CERTIFICATION

ETL: Rated for indoor dry/damp locations. Conforms to UL Standard 1598 and certified to CAN/CSA Standard C22.2 No. 250.0.

WARRANTY

Lumenwerx provides a five-year limited warranty on electrical and mechanical performance of the luminaires, including the LED boards, drivers, and auxiliary electronics. Lumenwerx will repair or replace defective luminaires or components at our discretion, provided they have been installed and operated in accordance with our specifications. Other limitations apply, please refer to the full warranty on our website.

Wall controllers are covered by the manufacturer warranty.

SQUERO HUBS

PENDANT

CHROMAWERX - SOLA, DUO



DUO DMX SPECIFICATION

A qualified DMX integrator is required to assure proper installation and commissioning of the DMX network. **When placing the PO, please provide the contact information of your DMX integrator.**

Please answer the following questions to help us identify your DMX network requirements.

YES

Do you require a wall controller provided by Lumenwerx?

NO

DMX controller supplied by Lumenwerx

DMX control system supplied by others. Lumenwerx will supply DMX-enabled fixtures with default DMX addressing. See following pages for technical DMX informations. ✓

How many zones do you have?

A zone consists of one or more luminaires behaving identically.

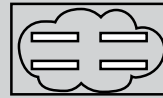

1 Zone



2 Zones

How to calculate the required number of drivers:

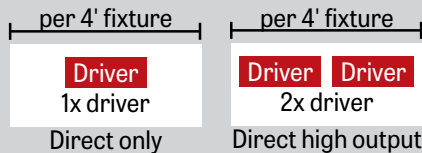

To Calculate # of drivers

1 - 4 Zones

5 or more Zones

Do you have more than 32 drivers in total?

NO

YES

Order a standard Lumenwerx wall controller.

WALL CONTROLLER

WCW - wall controller white
WCB - wall controller black

Add the control code at the end of your order code. Please provide a fixture layout or RCP (Reflected Ceiling Plan) showing the locations of the DMX fixtures, zones and the DMX wall controller. Refer to your DMX integrator for the installation. ✓

Subject to factory evaluation. Please contact our controls specialist at controls@lumenwerx.com. Additional cost and equipment will be required. ✓

Subject to factory evaluation and approval. Please contact our controls specialist at controls@lumenwerx.com. Additional cost and equipment will be required. ✓

SQUERO HUBS

PENDANT

CHROMAWERX - SOLA, DUO



GENERIC DMX NETWORK ARCHITECTURE

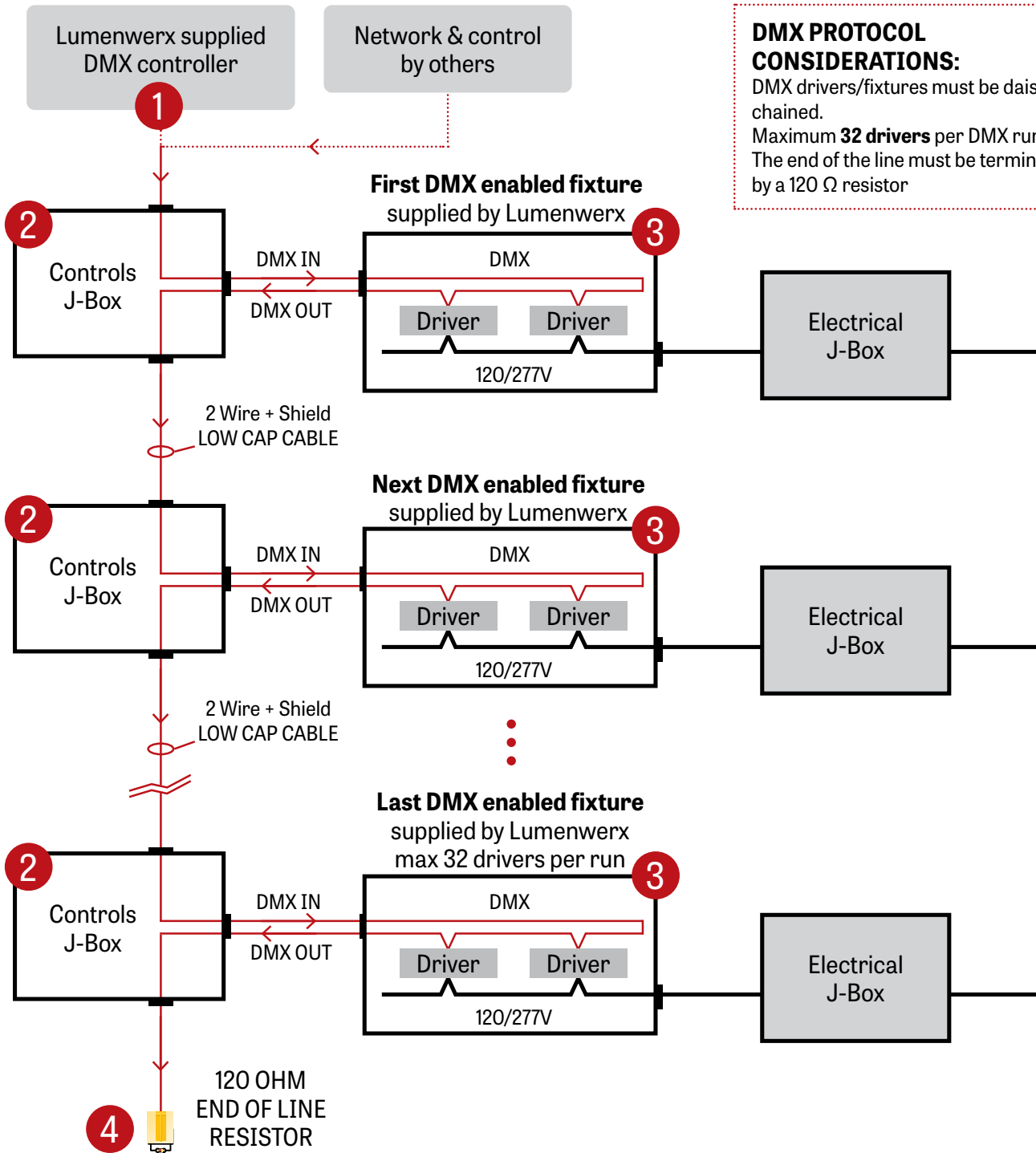

DMX PROTOCOL CONSIDERATIONS:

DMX drivers/fixtures must be daisy chained.
Maximum **32 drivers** per DMX run.
The end of the line must be terminated by a 120 Ω resistor

SQUERO HUBS

PENDANT

CHROMAWERX - SOLA, DUO



1 LUMENWERX SUPPLIED DMX CONTROLLER

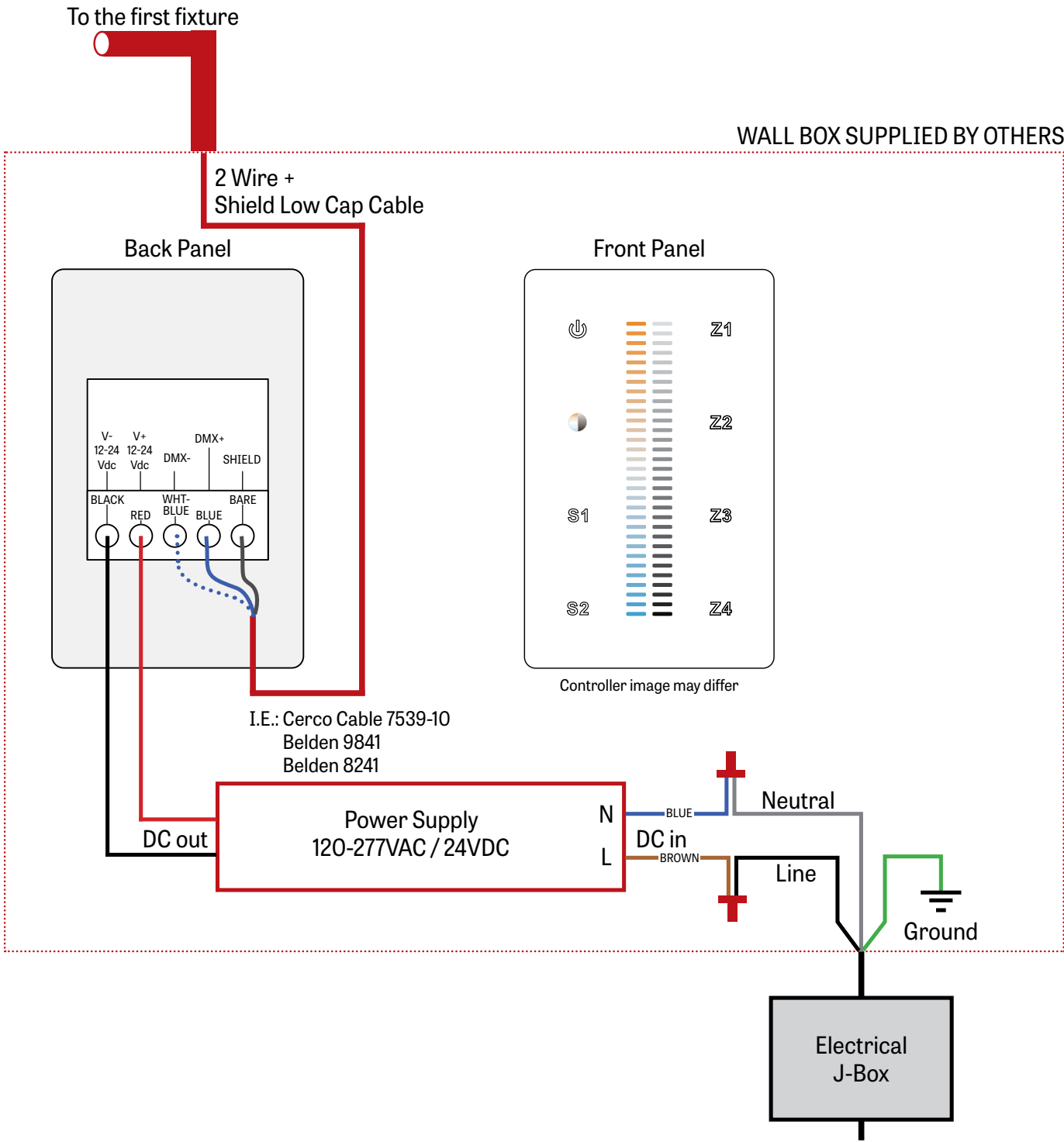

SQUERO HUBS

PENDANT

CHROMAWERX - SOLA, DUO



2 J-BOX DMX DAISY CHAIN DETAIL

Low capacitance DMX Cable from Previous Fixture

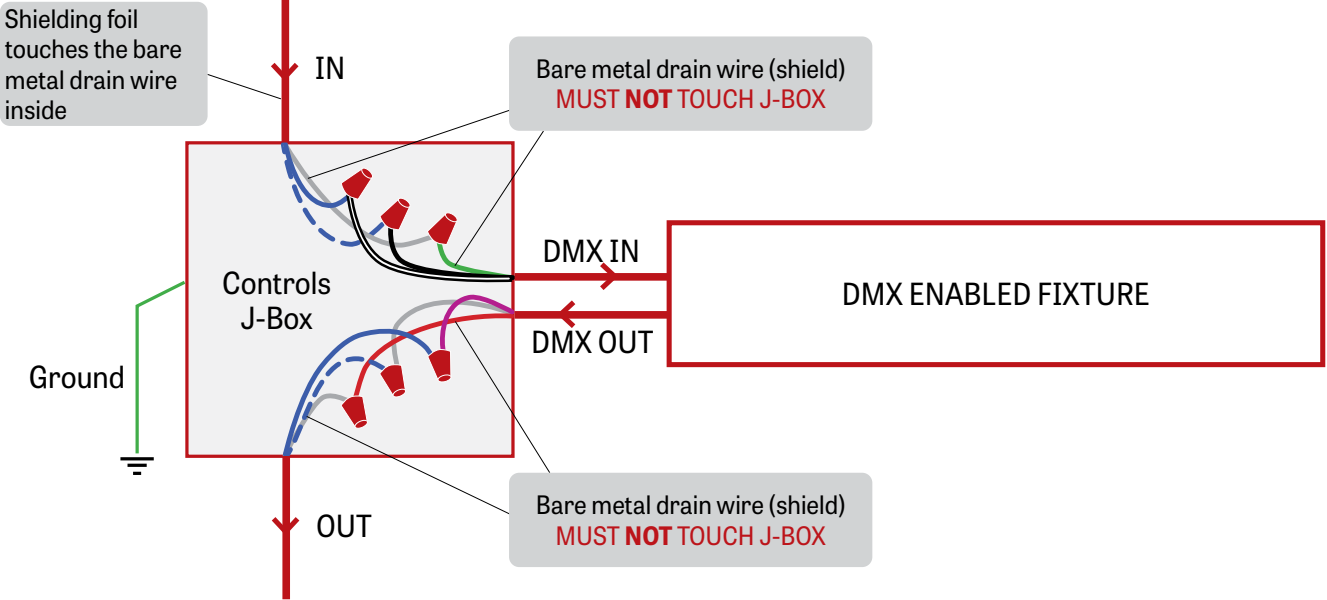

Low capacitance DMX cable to next fixture

3 DMX CONNECTION PENDANT & WALL

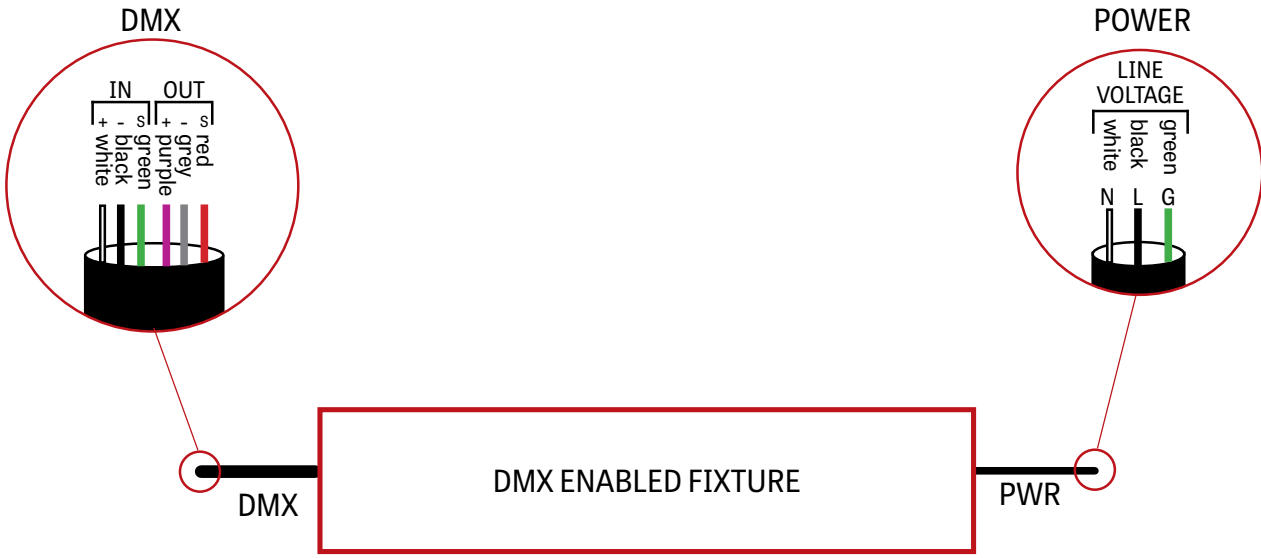

SQUERO HUBS

PENDANT

CHROMAWERX - SOLA, DUO



4 DMX LAST FIXTURE DETAIL

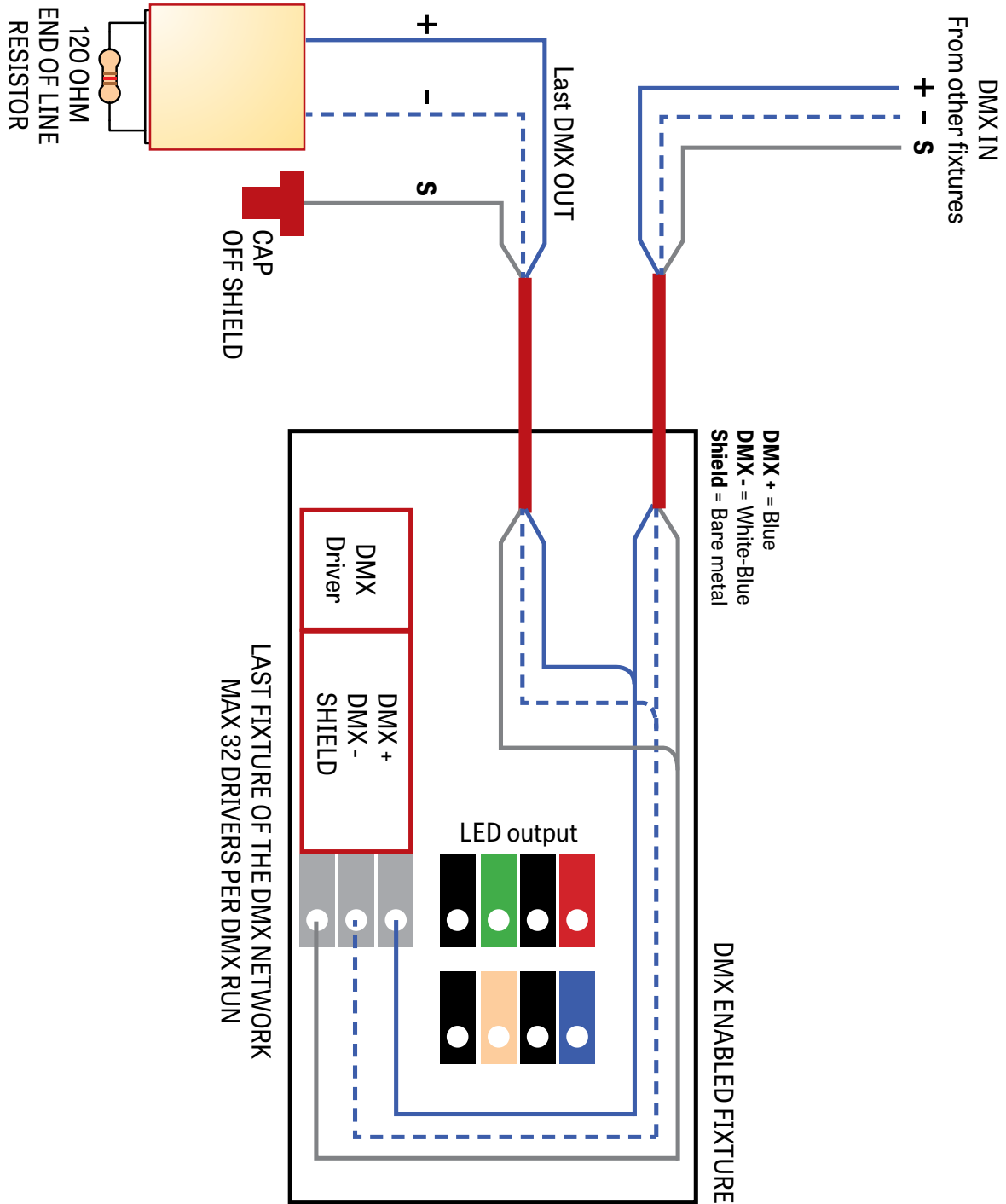

SQUERO HUBS

PENDANT

CHROMAWERX - SOLA, DUO



DMX WALL CONTROLLER

DUO 1-4 ZONE

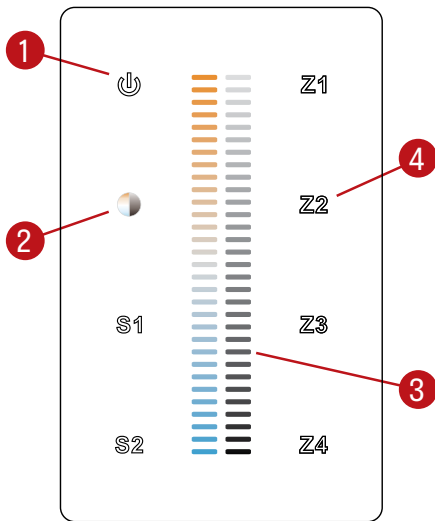

- (1) Power: Use this button to turn ON or OFF the fixture.
- (2) Brightness/CCT: Use the color/brightness toggle button to choose between color/brightness. When Blue: brightness is selected, when Yellow: color is selected.
- (3) Slider: Depending on the mode chosen in step 2, the slider will allow the user to set desired color or brightness.
- (4) Zone select: Up to 4 zones can be selected either independently or together. Once selected, the commands will be sent to the zone identified by a Blue LED.

Default DMX Addresses:

- 1 Warm
- 2 Cool

SQUERO HUBS

PENDANT

CHROMAWERX - SOLA, DUO



DUAL 0-10V WALL CONTROLLER

Front Panel

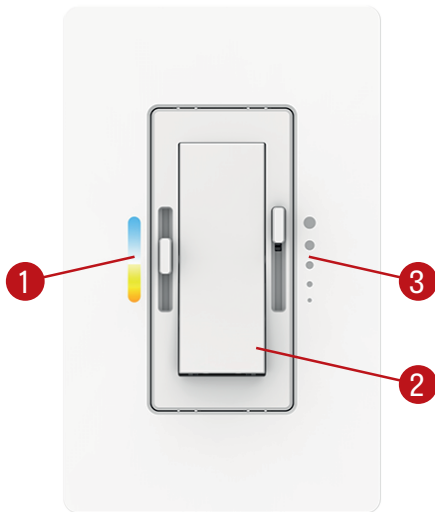

Controller image may differ

Dimensions

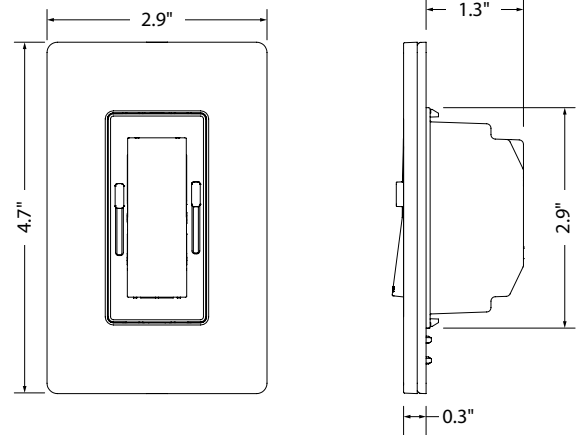

- (1) CCT control: Use this button to adjust the color temperature.
- (2) On/Off switch: Use this button to turn ON or OFF the fixture.
- (3) Dimming control: Use this button to adjust the brightness.

Wiring Diagram

