

INSTALLATION INSTRUCTIONS

! This product must be installed in accordance with the National Electrical Code and all applicable local codes, by a person familiar with the construction and operation of the product, and the hazards involved. Proper grounding is required for safety.

Ce produit doit être installé suivant le code national de l'électricité, ainsi que tous les codes locaux applicables, par une personne familière avec la construction et le fonctionnement du produit, ainsi que tous les risques qui y sont associés. La mise à terre électrique est obligatoire pour la sécurité.

! Disconnect power before installation or servicing.

! Do not cover the light element lens or heatsink with any materials or adhesive tapes when the fixture is powered.

! Handle the LED cartridge carefully during removal and installation. Tools must not touch the LED chips. Contact may result in damage and LED failure.

! Wire dimming conductors as Class 1.

! A luminaire with more than one power supply connection means shall be connected to only one branch circuit.

For electrical connections, please refer to the [wiring diagram guide](#).



For remote driver box installation instructions, please refer to the [remote driver installation sheet](#).



POC POWER-OVER-AIRCRAFT CABLE

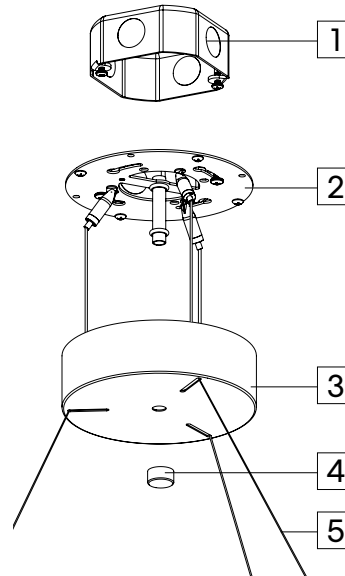

AC AIRCRAFT CABLE

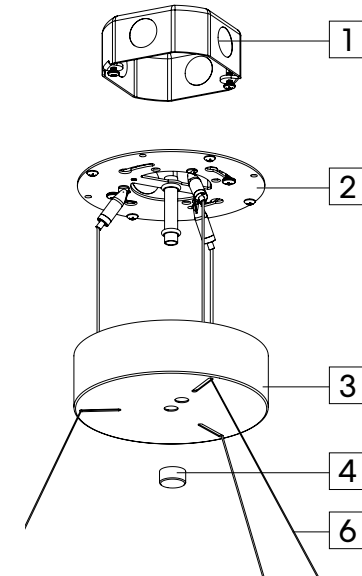

INDEX

POC.....	P2
Aircraft cable.....	P4

Number of cables may vary.

ITEMS LIST

1	Standard J-box (by others)
2	Mounting plate
3	Canopy
4	Decorative nut
5	Power-over-aircraft cable
6	Aircraft cable

TOOLS REQUIRED

- Phillips screwdriver
- Aircraft cable cutter
- 1/4" drill bit
- Scissors (for POC)

TOGO

Pendant - Remote Driver Box (RDB) - Single Canopy



POC (POWER-OVER-AIRCRAFT CABLE)

1 PREPARE MOUNTING POINTS.

Loosen the decorative nut [A] on the canopy [B]. Separate the canopy [B] from the mounting plate [C].

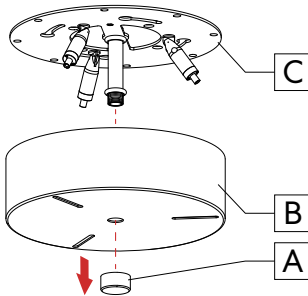

Fix the mounting plate [C] on the junction box [D].

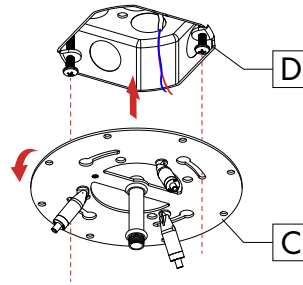

Use the mounting plate [C] as a model to mark 4 holes.

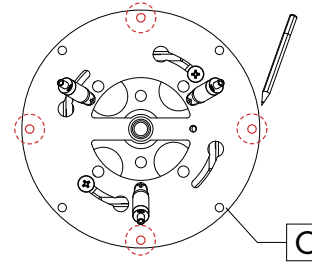

Remove the mounting plate. Drill holes (Ø 1/4") following the red marks. Install #8 drywall anchors [E].

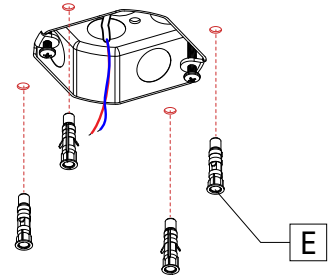

2 FIX MOUNTING PLATE TO CEILING.

Tighten the two screws [F] to secure the mounting plate [C] to the junction box.

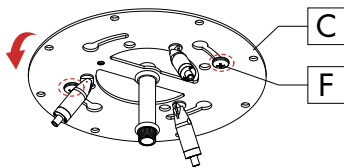

Use #8 screws [G] to fasten the mounting plate [C] to the ceiling.

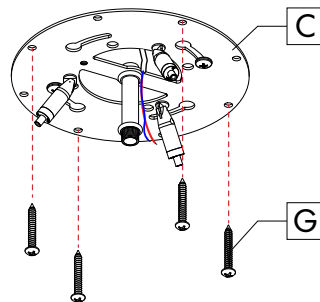

3 INSTALL AIRCRAFT CABLES.

Pass all aircraft cables [H] through the canopy [B]. Insert them into the griplocks [I]. Adjust the cables by pushing the feeder tube [I].

Cut the excess cables with an aircraft cable cutter [J].

Note: Height adjustment of the fixture must be done at this step. Leave POC (power-over-aircraft cable) length of 1.5" to make the connection inside the junction box.

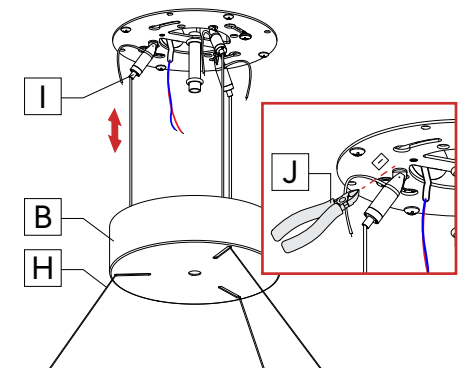

POC (POWER-OVER-AIRCRAFT CABLE)

4 MAKE ELECTRICAL CONNECTIONS.

Make electrical connections between POC (power-over-aircraft cable) [H] and the remote driver feed [K].

Note: Make sure that you are connecting the negative (-) POC (as marked on the fixture with blue color and a label) to your negative wire and the positive (+) POC (as marked on the fixture with red color and a label) to your positive wire.

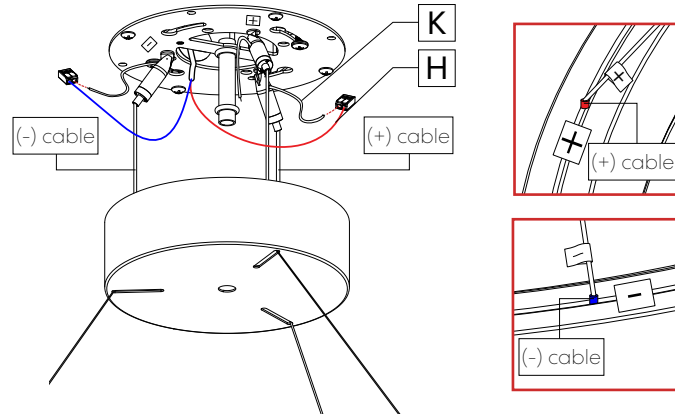

5 REINSTALL CANOPY.

Put the canopy [B] back in place and fix using the decorative nut [A].

Cut the labels [L] off the wires.

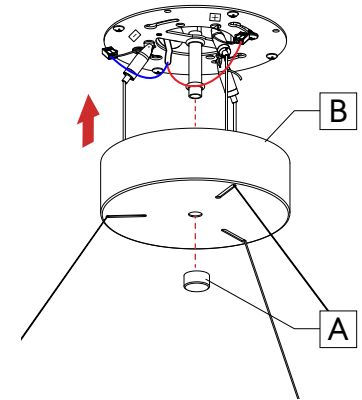
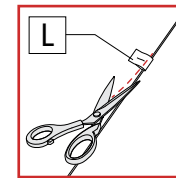

TOGO

Pendant - Remote Driver Box (RDB) - Single Canopy



AC (AIRCRAFT CABLE)

1 PREPARE MOUNTING POINTS.

Loosen the decorative nut [A] on the canopy [B]. Separate the canopy [B] from the mounting plate [C].

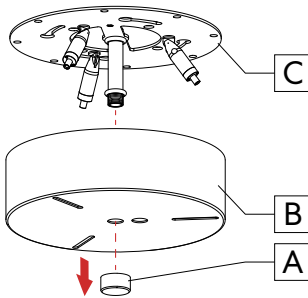

Fix the mounting plate [C] on the junction box [D].

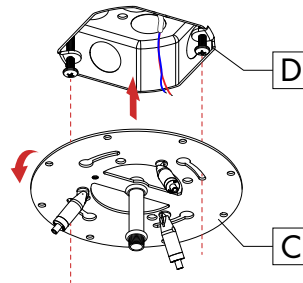

Use the mounting plate [C] as a model to mark 4 holes.

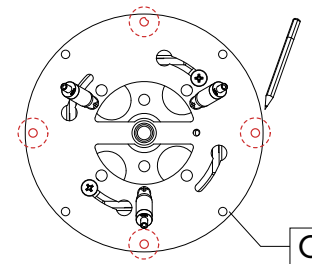

Remove the mounting plate. Drill holes (Ø 1/4") following the red marks. Install #8 drywall anchors [E].

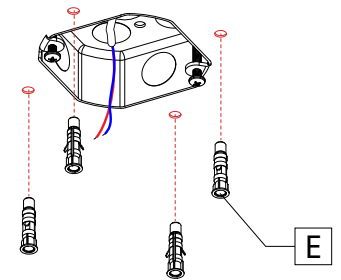

2 FIX MOUNTING PLATE TO CEILING.

Tighten the two screws [F] to secure the mounting plate [C] to the junction box.

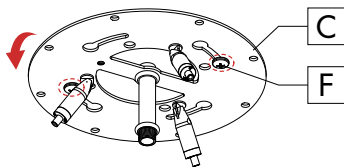

Use #8 screws [G] to fasten the mounting plate [C] to the ceiling.

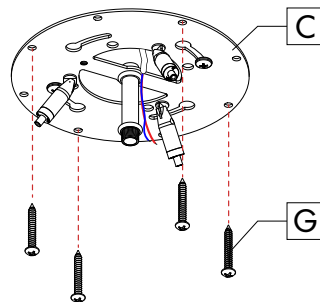

3 INSTALL AIRCRAFT CABLES.

Pass all aircraft cables [H] through the canopy [B]. Insert them into the griplocks [I]. Adjust the cables by pushing the feeder tube [I].

Cut the excess cables with an aircraft cable cutter [J].

Note: Height adjustment of the fixture must be done at this step.

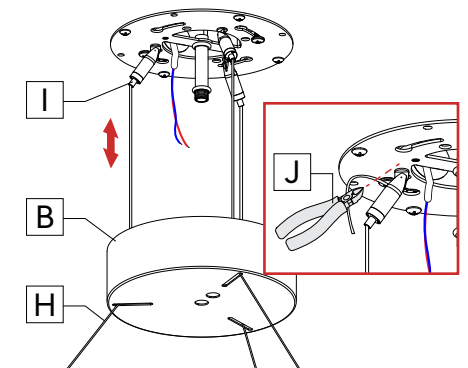

AC (AIRCRAFT CABLE)

4 MAKE ELECTRICAL CONNECTIONS.

Pass the power cord [K] into the canopy [B] and make a knot. Make electrical connections between the power cord [K] and the remote driver feed [L] with wire nuts [M] (by others).

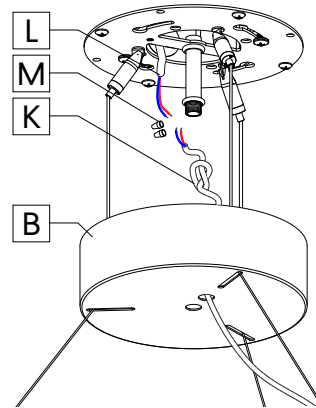

5 REINSTALL CANOPY.

Secure the power cord [K] to the aircraft cable [H] with plastic clip [N].

Put the canopy [B] back in place and fix using the decorative nut [A].

