

UBIK

RECESSED
CHROMAWERX - SOLA AND DUO

LUMENWERX



Project: _____

Type: _____

DESCRIPTION

Sleek square form meets superb function in Ubiq, a lighting family designed to provide a multitude of creative options. These compact 2" wide recessed fixtures are offered with parabolic louver, HLO, or wall wash optics for direct illumination.



Up to 145 lm/W performance

OPTICS

Parabolic Louver



Matte White



Matte Silver



Matte Black

High-Efficiency Lambertian Optic

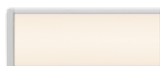

Wall Wash Optic



Matte White



Matte Silver



Matte Black

UBIK

RECESSED
CHROMAWERX - SOLA AND DUO



Project: _____
Type: _____

LUMENWERX

Order Guide

LUMINAIRE ID	DISTRIBUTION	OPTIC	LIGHT SOURCE ²	CRI
UBIR	D			
UBIR - Ubik Recessed	D - Direct	MWPL - Matte White Parabolic Louver MSPL - Matte Silver Parabolic Louver MBPL - Matte Black Parabolic Louver HLO - High-Efficiency Lambertian Optic WWW¹ - Wall Wash White Optic WWS¹ - Wall Wash Silver Optic WWB¹ - Wall Wash Black Optic	SOLA - Dim-to-warm single channel control 35K to 22K DUO - Tunable white 2-channel control 65K to 27K ² Static white and BIOS also available. Consult other spec sheet.	80 - 80CRI 90 - 90CRI

¹Available in 4' and 8' lengths only.

LUMEN PACKAGE	LUMINAIRE LENGTH	VOLTAGE	DRIVER ⁵
350 - Low output 350 lm/ft 500 - Medium output 500 lm/ft 750³ - High output 750 lm/ft ³ Available for non-IC applications only.	#FT⁴ - Specify nominal length (#) in 1 foot increments Standard nominal lengths: Single units: 4' to 12' Continuous runs: lengths over 12' ⁴ Wall wash available with 4' and 8' fixtures only.	120 - 120V 277 - 277V UNV - 120V-277V	SOLA SDI - Single 0-10V input DUO DMX⁶ - DMX, to specify see pages 8 to 13 DDA⁶ - DALI DT6 DDA8⁶ - DALI DT8 DDI - Dual 0-10V input for CCT/intensity LD2⁶ - Lutron DALI-2 digital ⁵ PoE (Power-over-Ethernet) compatible. Consult factory for details. ⁶ On-site commissioning is required.

ELECTRICAL	MOUNTING	FINISH	OPTIONS
1C			
1C - 1 circuit	TG9 - Tegular 9/16" TG15 - Tegular 15/16" TB9 - T-bar 9/16" TB15 - T-bar 15/16" ST - Screw slot T-bar DTR - Drywall trim DTL - Drywall trimless DMF - Drywall mud flange	W - Matte white AL - Aluminum B - Matte black WA - White antimicrobial Silverwerx CF# - Custom finish, specify RAL#	FU120 - Fuse 120V FU277 - Fuse 277V FWC - Flexible whip cable (6' std) CP - Chicago Plenum NA - None

Accessories

Optional, order separately

DMX WALL CONTROLLER ⁷

WCW - Wall controller white
WBW - Wall controller black

⁷Available with DMX only. For more information, see pages 8 to 13, or consult factory.

UBIK

RECESSED CHROMAWERX - SOLA AND DUO



Project: _____

Type: _____

Photometrics

Watts and lumens per watt may vary based on the type of driver selected.

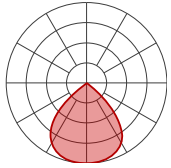

MWPL - Delivered Lumens at 35K at 80 CRI

LUMENS PER FOOT	TOTAL LUMENS PER 4FT	INPUT WATTAGE	LPW
350	1400	10.2	137
500	2000	15.2	132
750	3000	23.6	127

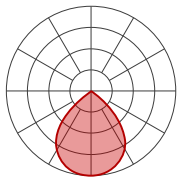

MSPL - Delivered Lumens at 35K at 80 CRI

LUMENS PER FOOT	TOTAL LUMENS PER 4FT	INPUT WATTAGE	LPW
350	1400	11.2	125
500	2000	16.7	120
750	3000	26.1	115

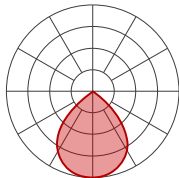

MBPL - Delivered Lumens at 35K at 80 CRI

LUMENS PER FOOT	TOTAL LUMENS PER 4FT	INPUT WATTAGE	LPW
350	1400	12.8	109
500	2000	19.0	105
750	3000	29.7	101

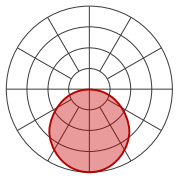

HLO - Delivered Lumens at 35K at 80 CRI

LUMENS PER FOOT	TOTAL LUMENS PER 4FT	INPUT WATTAGE	LPW
350	1400	9.7	145
500	2000	14.3	140
750	3000	22.2	135

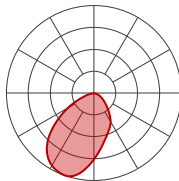

WWW - Delivered Lumens at 35K at 80 CRI

LUMENS PER FOOT	TOTAL LUMENS PER 4FT	INPUT WATTAGE	LPW
350	1400	13.5	104
500	2000	20.0	100
750	3000	31.9	94

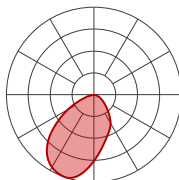

WWS - Delivered Lumens at 35K at 80 CRI

LUMENS PER FOOT	TOTAL LUMENS PER 4FT	INPUT WATTAGE	LPW
350	1400	14.3	98
500	2000	21.1	95
750	3000	33.7	89

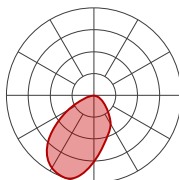

WWB - Delivered Lumens at 35K at 80 CRI

LUMENS PER FOOT	TOTAL LUMENS PER 4FT	INPUT WATTAGE	LPW
350	1400	16.1	87
500	2000	24.1	83
750	3000	38.5	78

UBIK

RECESSED
CHROMAWERX - SOLA AND DUO

LUMENWERX



Project: _____

Type: _____

Dimensions

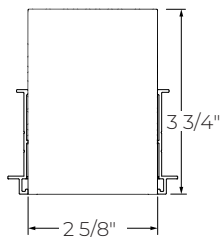

Technical Specifications

OPTICS

High-Efficiency Lambertian Optic (HLO)

The High-Efficiency Lambertian Optic (HLO) shielding of diffusing 0.075" thick acrylic with up to 88% transmission and good source obscuration is combined with matte white side reflectors to create an efficient optical chamber with uniform luminosity. Luminaire brightness is controlled by the flux-to-shielding area ratio. For visual comfort, avoid high lumen output unless Ubik is installed in a high ceiling application.

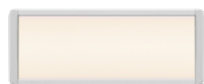

Wall Wash Optics

Ubik wall wash is an offset horizontal linear LED array that reflects from a matte white internal side kicking reflector. It then transmits through the beam-forming lens and then softened by a 2" asymmetric louver. The lens is fully illuminated, and the wall wash is only slightly angled to complement the direct optic.



Parabolic Louvers

Parabolic louvers provide excellent shielding and a pleasing crisp visual texture. The precisely molded louvers consist of 1" deep blades and is 2"x2" in size. The LED array is secured in the direct position, with the light transmitting through a beam-forming lens creating a conical distribution. Three matte (MPL) finishes are available in black, white and silver, offering a soft appearance, a wide beam spread of up 85-91 degrees, gentle brightness transition at cut-off, and exceptional UGR.



UBIK

RECESSED CHROMAWERX - SOLA AND DUO

LUMENWERX



Project: _____

Type: _____

LIGHT SOURCE

Custom linear array of alternating color temperature mid-flux LEDs are mounted directly to the housing for optimal thermal performance. For the Duo products, a color temperature range from 6500K-2700K is achievable with color points on or below the black body curve. For the Sola products, a color temperature range from 3500K-2200K is controlled synchronously with intensity. Color consistency between fixtures is maintained to within 3 SDCM. LEDs are operated at reduced drive current to optimize efficacy and lumen maintenance.

All LEDs have been tested in accordance with IESNA LM-80-08 and the results have shown L80 lumen maintenance greater than 60,000 hours. Absolute product photometry is measured and presented in accordance with IESNA LM-79, unless otherwise indicated.

CHROMAWERX - TUNABLE WHITE

Chromawerx SOLA

It is a single-channel control that dims output while warming the color temperature in a pre-determined relationship. A simple analog control sends a common signal to dual output digital drivers, which are programmed to adjust a specially populated LED array to emulate the effect of dimming a filament source. Dimming range is programmable but the default option runs from 3500K at 100% of full power to 2200K at 5% of full power. CRI is maintained above 80 throughout the dimming range.

Chromawerx DUO

It is a two-channel control. It uses an analog (0-10V) protocol for separate control of luminaire CCT and intensity or a digital (DMX, DALI and LD2) protocol for synchronous control of both warm and cool LED arrays to enable the user to set color temperature and light output. Commonly called "tunable white", Chromawerx two-channel control provides the range of warm (2700K) to cool (6500K) color that can be useful for helping to entrain circadian rhythms, stimulate alertness for improved educational and work productivity, and compensate for jet lag, among other applications. The Chromawerx drivers are programmed to limit maximum light output and power usage across all color temperatures. CRI is maintained above 80.

ANSI C78.377-2015

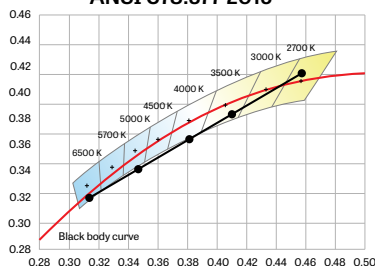

LUMINAIRE LENGTH

Ubik is made up of standard 4 to 12 foot sections that may be joined together to create longer continuous run lengths. Exact run lengths must be noted in the product code. The minimum length is 4 feet. Lengths can be ordered in 1 foot increments.

All individual sections are joined together onsite using the joiner kits provided. Lumenwerx offers joiner kits that are extremely simple to work with in the field and result in a fixture that appears virtually seamless with no light leak at any connection.



WELL for Light - The WELL building standard focuses on light quality in several features. There are three categories that are fully attributed to the construction and features of a luminaire. In WELL V1, it's Feature 54 Circadian Lighting, Feature 55 Glare Control, and Feature 58 Color Quality. In WELL V2, it's Feature L03 Circadian Lighting, Feature L04 Glare Control, and Feature L07 Electric Light Quality.

This fixture meets Features:

- Feature 54 or L03 when DUO is selected
- Feature 55 or L04 meets WELL glare category (b-c-d)
- Feature 58 or L07 when 90CRI is selected

All LED drivers used at Lumenwerx are deemed to have a low risk level of flicker, of 5 % or less below 90Hz operational as defined by IEEE standard 1789-2015 LED.



WELL for Mind -This luminaire meets WELL for mind as it is a human centric luminaire offering quality light, excellent color, and smooth optics. If any of these features are incorporated in a luminaire, it can improve the ability to focus, concentrate, and persist longer on a given task. This fixture harmoniously operates in a space to assist the mind.

For more information please contact well@lumenwerx.com.

UBIK

RECESSED
CHROMAWERX - SOLA AND DUO

LUMENWERX



Project: _____

Type: _____

ELECTRICAL

DMX (DUO only)

Factory-set adjustable output current electronic driver with 120-277 VAC line input. Using DMX wall controls (optionally supplied by Lumenwerx) or an existing DMX control system, both channels of LEDs are independently adjustable. Each DMX driver can be independently addressed using the built-in RDM (Remote Device Management) in the field. Dimming down to 1% is attainable. Rated life (90% survivorship) of 50,000 hours at 50°C maximum ambient temperature. At maximum driver load, efficiency < 84%, PF > 0.9, THD < 20%.

DALI (DUO only)

Factory-set adjustable output current electronic driver with 120-277 VAC line input. Using an existing DALI control system (supplied by others), one control channel adjusts the fixture color temperature, and the other control channel adjusts fixture brightness. With DALI Type 6, two DALI addresses are required to control both channels. With DALI Type 8, one DALI address is required to control both channels. Dimming down to 1% is attainable. Rated life (90% survivorship) of 50,000 hours at 50°C maximum ambient temperature. At maximum driver load, efficiency < 84%, PF > 0.9, THD < 20%.

SD1 (SOLA)

Factory-set, adjustable output current LED driver with universal (120-277 VAC) input. Using a single 0-10V control signal, the light output warms in color temperature as it dims down to 1% and 2200K. At maximum driver load, efficiency < 86%, PF > 0.9, THD < 20%.

DD1 (DUO)

Factory-set adjustable output current LED driver with universal (120-277 VAC) input. Controlled via two individual 0-10V signals, one for setting light output down to a minimum of 1% and the other for adjusting the CCT (default range of 2700K-6500K). Rated life of 50,000 hours at 70°C maximum driver case temperature and 100% load conditions. Typical efficiency of 86%, PF > 0.9, THD < 20% at 100% load conditions.

LD2 (DUO only)

Lutron DALI-2 digital drivers provide a high-performance tunable white solution with single-address digital control. Guaranteed performance and compatibility when used with Lutron DALI-2 controls.

PoE

Depending on the PoE manufacturer selected, Lumenwerx will install the node in factory as either integral to the luminaire, or as a remote module. Factory programming of the PoE node may or may not enable the following functionalities: lumen package, Duo (tunable white), emergency battery backup, and sensor integration. These must be addressed and evaluated on a case-by-case basis.

MOUNTING

Recessed fixtures can be mounted into exposed or concealed T-Bar or Tegular grid ceilings.

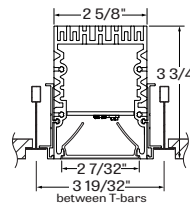

TG9 - Tegular 9/16"

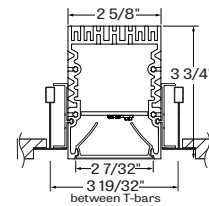

TG15 - Tegular 15/16"

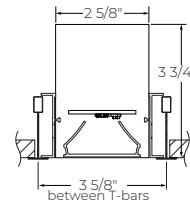

TB9 - T-bar 9/16"

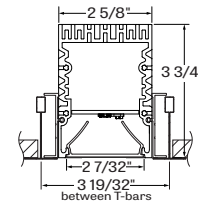

TB15 - T-bar 15/16"

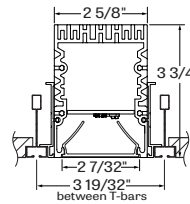

ST - Screw slot T-bar

UBIK

RECESSED
CHROMAWERX - SOLA AND DUO

LUMENWERX



Project: _____

Type: _____

Mounting for drywall ceilings are available with visible trim, trimless or mud flange.

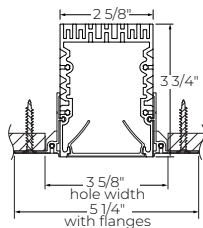

DMF - Drywall mud flange

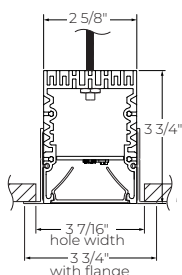

DTR - Drywall trim

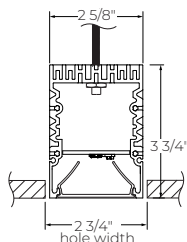

DTL - Drywall trimless

CONSTRUCTION

Housing - Extruded aluminum (0.070" nominal) up to 90% recycled content

Joiner bracket (DTL-DTR) - Cold drawn steel 8 gauge thick

Joiner bracket (other) - Galvanised steel 16 gauge thick

Louvers - Injection molded optical grade polycarbonate up to 95% reflective

HLO lens - Coextruded PMMA

Parabolic heatsink - Extruded aluminum (0.10" nominal) up to 90% recycled content

HLO/WW heatsink - Aluminum sheet 10 gauge thick

End plate - Aluminum sheet 0.19" thick

FINISH

Interior - 95%, reflective matte powder coated white paint

Exterior - Powder-coat paint in standard white, aluminum, or black. Custom colors are also available.

WEIGHT

Ubik 4ft - 14.2 lbs - 6.4 kg

Ubik 6ft - 21.3 lbs - 9.7 kg

Ubik 8ft - 28.4 lbs - 12.9 kg

Ubik 12ft - 35.5 lbs - 16.1 kg

CERTIFICATIONS

ETL - Rated for Indoor Dry/Damp locations. Conforms to UL Standard 1598 and certified to CAN/CSA Standard C22.2 No. 250.0.

IC rated - Suitable for direct contact with insulation

Chicago Plenum - City of Chicago approved (CCEA)

WARRANTY

Lumenwerx provides a five-year limited warranty of electrical and mechanical performance of the luminaires, including the LED boards, drivers, and auxiliary electronics. Lumenwerx will repair or replace defective luminaires or components at our discretion, provided they have been installed and operated in accordance with our specifications. Other limitations apply, please refer to the full warranty on our website.



Project: _____

Type: _____

DUO DMX SPECIFICATION

A qualified DMX integrator is required to assure proper installation and commissioning of the DMX network. **When placing the PO, please provide the contact information of your DMX integrator.**

Please answer the following questions to help us identify your DMX network requirements.

YES

Do you require a wall controller provided by Lumenwerx?

NO

DMX control system supplied by others. Lumenwerx will supply DMX-enabled fixtures with default DMX addressing. See following pages for technical DMX informations.

DMX controller supplied by Lumenwerx

How many zones do you have?
A zone consists of one or more luminaires behaving identically.

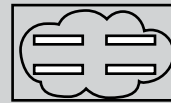

1 Zone



2 Zones

How to calculate the required number of drivers:

per 4' fixture

Driver
1x driver
Direct only

per 4' fixture

Driver Driver
2x driver
Direct high output

To Calculate # of drivers

1 - 4 Zones

5 or more Zones

Do you have more than 32 drivers in total?

NO

YES

Order a standard Lumenwerx wall controller.

WALL CONTROLLER

WCW - wall controller white
WCB - wall controller black

Add the control code at the end of your order code.

Please provide a fixture layout or RCP (Reflected Ceiling Plan) showing the locations of the DMX fixtures, zones and the DMX wall controller.

Refer to your DMX integrator for the installation.

Subject to factory evaluation. Please contact our controls specialist at controls@lumenwerx.com. Additional cost and equipment will be required.

Subject to factory evaluation and approval. Please contact our controls specialist at controls@lumenwerx.com. Additional cost and equipment will be required.



GENERIC DMX NETWORK ARCHITECTURE

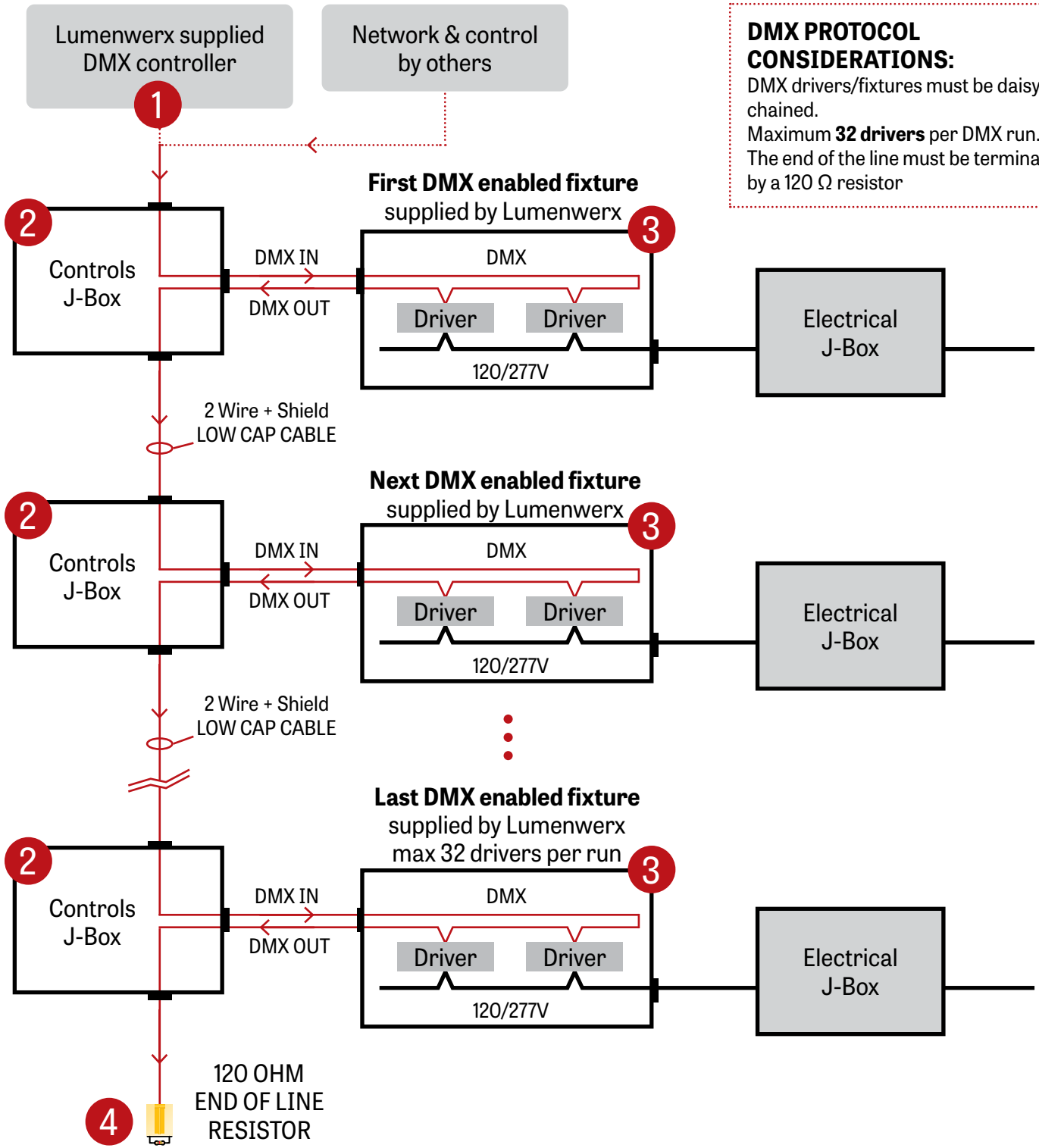

DMX PROTOCOL CONSIDERATIONS:
DMX drivers/fixtures must be daisy chained.
Maximum **32 drivers** per DMX run.
The end of the line must be terminated by a 120 Ω resistor



Project: _____

Type: _____

1 LUMENWERX SUPPLIED DMX CONTROLLER

To the first fixture

WALL BOX SUPPLIED BY OTHERS

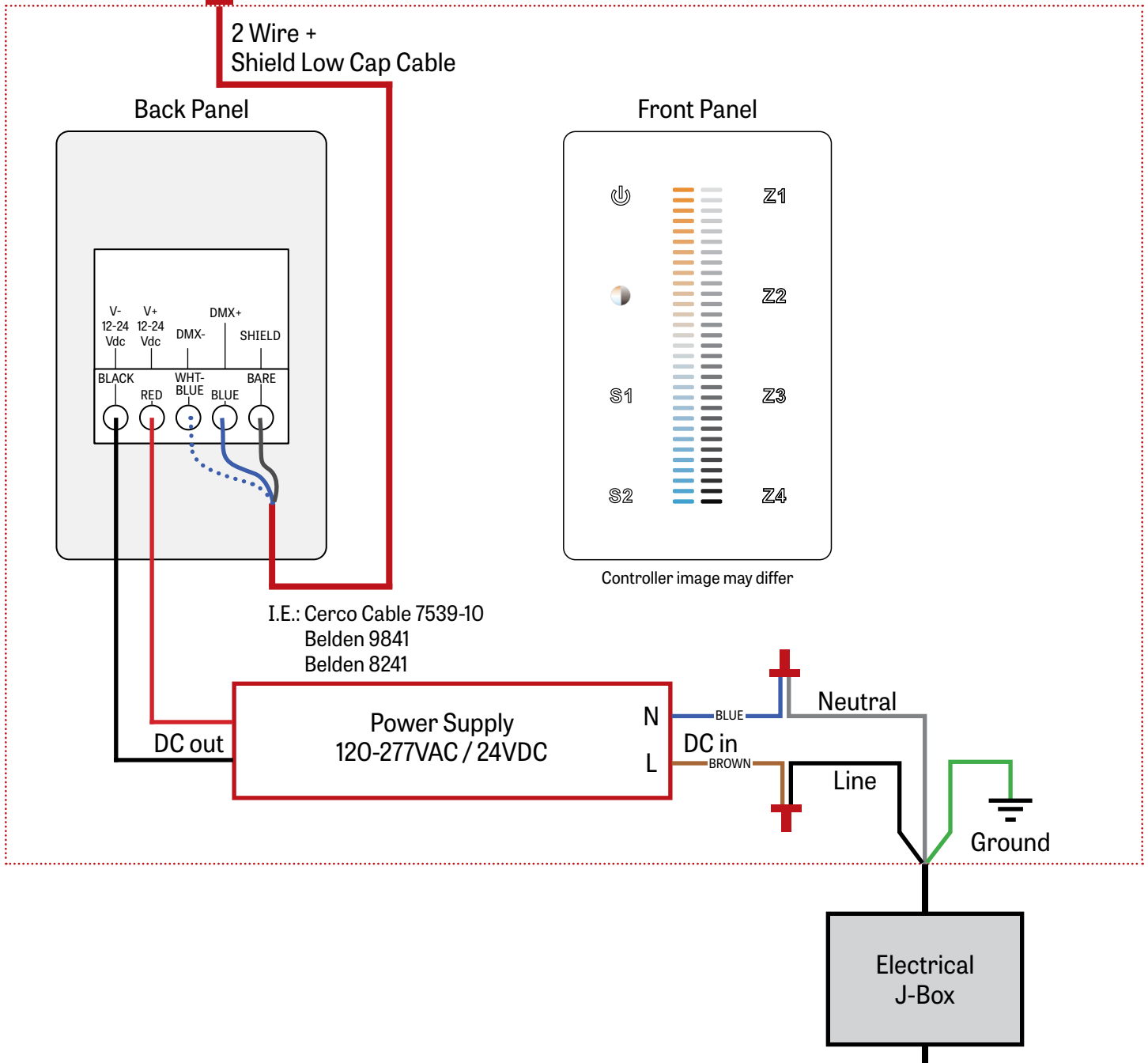



Project: _____

Type: _____

2 J-BOX DMX DAISY CHAIN DETAIL

Low capacitance DMX Cable from Previous Fixture

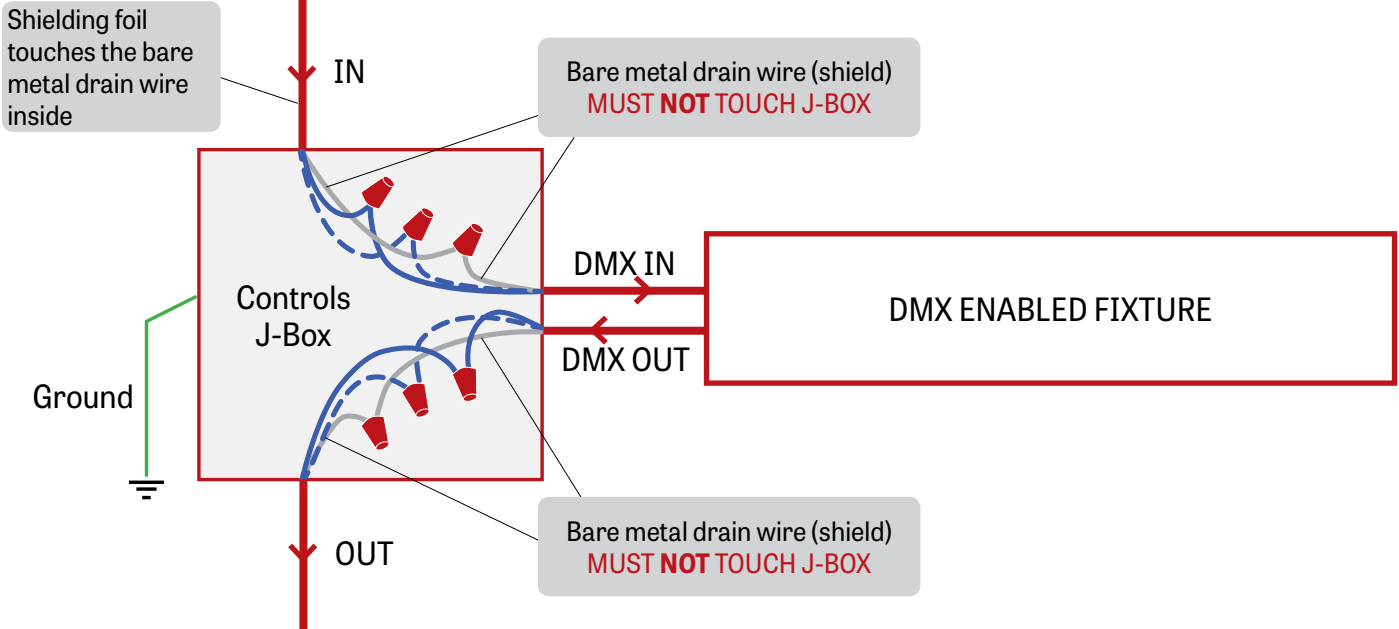

Low capacitance DMX cable to next fixture

3 DMX CONNECTION RECESSED & SURFACE

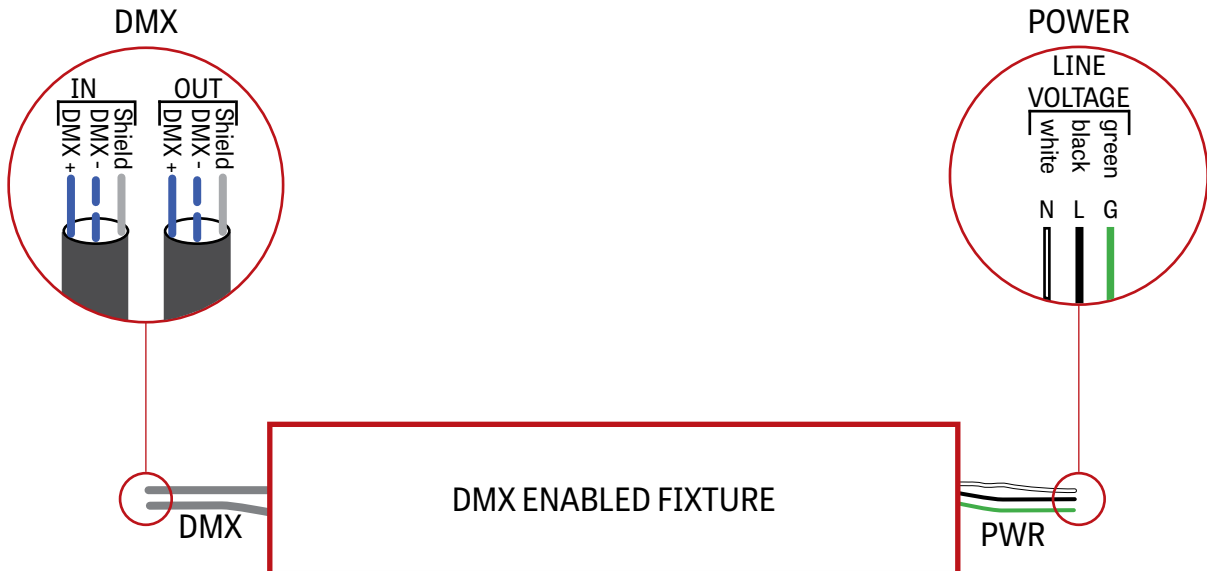



Project: _____

Type: _____

4 DMX LAST FIXTURE DETAIL

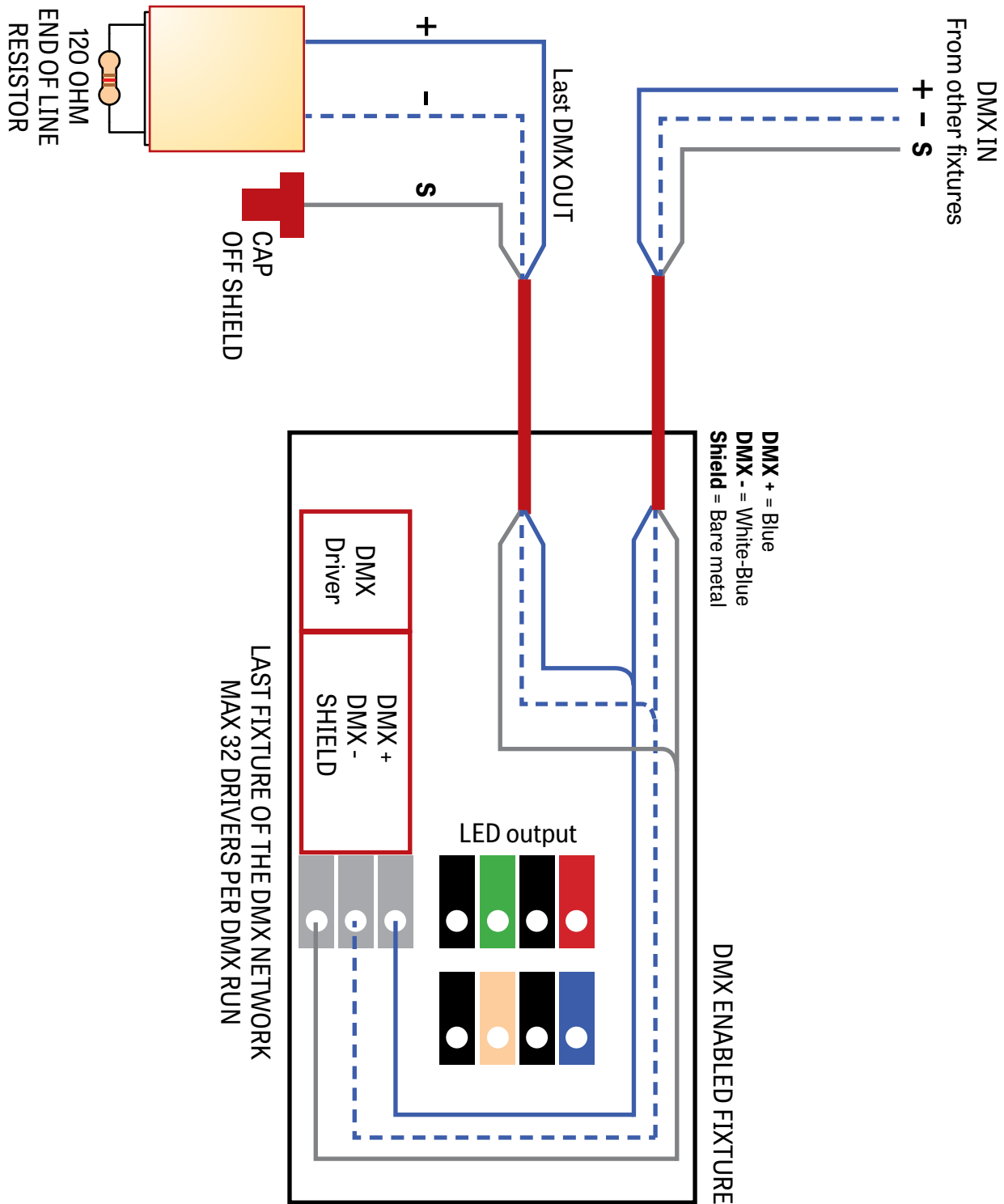

UBIK

RECESSED
CHROMAWERX - SOLA AND DUO



Project: _____

Type: _____

DMX WALL CONTROLLER

DUO 1-4 ZONE

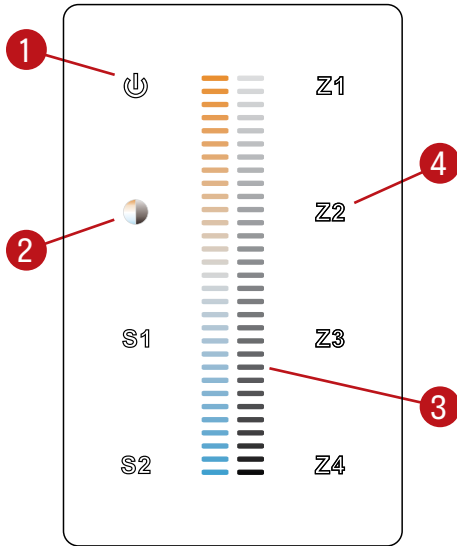

- (1) Power: Use this button to turn ON or OFF the fixture.
- (2) Brightness/CCT: Use the color/brightness toggle button to choose between color/brightness. When Blue: brightness is selected, when Yellow: color is selected.
- (3) Slider: Depending on the mode chosen in step 2, the slider will allow the user to set desired color or brightness.
- (4) Zone select: Up to 4 zones can be selected either independently or together. Once selected, the commands will be sent to the zone identified by a Blue LED.

Default DMX Addresses:

- 1 Warm
- 2 Cool