

UBIK SEAL

RECESSED
CHROMAWERX - SOLA, DUO

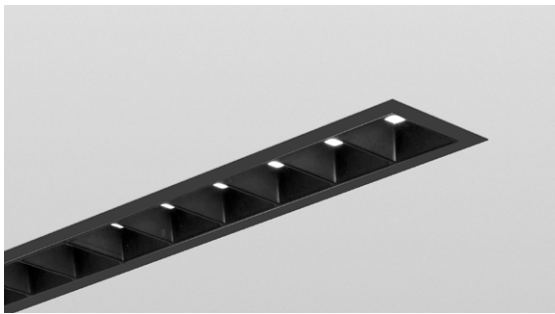

Project: _____
Type: _____



Parabolic Louver

DESCRIPTION

Sleek square form meets superb function in Ubik, a lighting family designed to provide a multitude of creative options. Ubik Seal Recessed is offered with a choice of three parabolic louver colors: matte white, matte black, and matte silver. An additional gasketed clear polycarbonate lens is mounted on top of the louvers for extra protection. Ubik Seal Recessed comes in Chromawerx SOLA and DUO. For static white and full spectrum, consult other spec sheet.

IC RATED



IP54

Order Guide

LUMINAIRE ID	DISTRIBUTION	OPTIC	LIGHT SOURCE ²	CRI
UBISEALR	D			
UBISEALR ¹ - Ubik Seal Recessed <small>¹IP54 rated gasketed construction with an additional clear polycarbonate lens.</small>	D - Direct	MWPL - Matte White Parabolic Louver MSPL - Matte Silver Parabolic Louver MBPL - Matte Black Parabolic Louver	SOLA - Dim-to-warm single channel control 35K to 22K DUO - Tunable white 2-channel control 65K to 27K <small>²Static white and full spectrum also available. Consult other spec sheet.</small>	80CRI - 80+ CRI 90CRI - 90+ CRI
LUMEN PACKAGE	LUMINAIRE LENGTH	VOLTAGE	DRIVER ⁴	
350LMF - Low output 350 lm/ft 500LMF - Medium output 500 lm/ft 750LMF ³ - High output 750 lm/ft <small>³Available for non-IC applications only.</small>	#FT - Specify nominal length (#) in 1' increments Standard nominal lengths: Single units: 4' to 12' Continuous runs: lengths over 12'	120V - 120V 277V - 277V UNV - 120V-277V	SOLA SD1 - Single 0-10V input DUO DMX ^{5,6} - DMX DDA ⁶ - DALI DT6 DDA8 ⁶ - DALI DT8 DD1 - Dual 0-10V input for CCT/intensity LD2 ⁶ - Lutron DALI-2 digital <small>⁴PoE (Power-over-Ethernet) compatible. Consult factory for details. ⁵For more information, see pages 6 to 11. ⁶On-site commissioning is required.</small>	
ELECTRICAL	MOUNTING	FINISH	OPTIONS ⁷	
1C				
1C - 1 circuit	TG9 - Tegular 9/16" TG15 - Tegular 15/16" TB9 - T-bar 9/16" TB15 - T-bar 15/16" ST - Screw slot T-bar MTR - Trim MTL - Trimless DMF - Drywall mud flange	W - Matte white AL - Aluminum B - Matte black WA - White antimicrobial Silverwerx CF# - Custom finish, specify RAL#	FU120 - Fuse 120V FU277 - Fuse 277V CP - Chicago Plenum GCK - Grid gasket CRF - Corrosion-resistant finish NA - None <small>⁷Separate codes with a "+" if more than one is specified.</small>	

Accessories

Optional, order separately

WALL CONTROLLER ⁸	
DMX WCW##FT ⁹ - DMX wall controller white WBW##FT ⁹ - DMX wall controller black <small>⁸Specify wire length (##) in feet. ⁹Available with DMX only. For more information, see pages 6 to 11, or consult factory.</small>	DD1 TWCW##FT ¹⁰ - Dual 0-10V wall controller white TWCB##FT ¹⁰ - Dual 0-10V wall controller black <small>¹⁰Available with DD1 only. For more information, see page 12, or consult factory</small>



UBIK SEAL

RECESSED
CHROMAWERX - SOLA, DUO



Photometrics

Values calculated based on a 4' fixture at 3500K and 80+ CRI for all optics. Watts and lumens per watt may vary based on the type of driver selected.

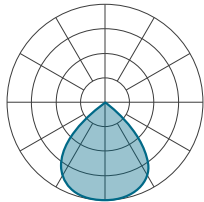

MWPL

LM/FT	W/FT	LM/W
350	2.6	135
500	3.8	132
750	5.9	127

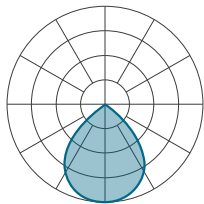

MSPL

LM/FT	W/FT	LM/W
350	2.8	125
500	4.2	120
750	6.5	115

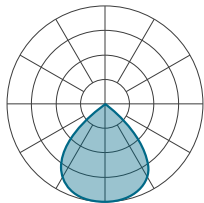

MBPL

LM/FT	W/FT	LM/W
350	3.2	109
500	4.7	105
750	7.4	101

Dimensions

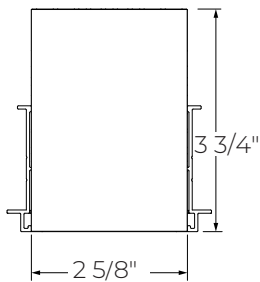

UBIK SEAL

RECESSED
CHROMAWERX - SOLA, DUO



Technical Specifications

OPTICS

Parabolic Louvers

Parabolic louvers provide excellent shielding and a pleasing crisp visual texture. The precisely molded louvers consist of 1" deep blades and is 2"x2" in size. The LED array is secured in the direct position, with the light transmitting through a beam-forming lens creating a conical distribution. Three matte finishes are available in black, white and silver, offering a soft appearance, a wide beam spread of up 85-91 degrees, gentle brightness transition at cut-off, and exceptional UGR.



LIGHT SOURCE

Custom linear array of alternating color temperature mid-flux LEDs are mounted directly to the housing for optimal thermal performance. For the DUO products, a color temperature range from 6500K-2700K is achievable with color points on or below the black body curve. For the SOLA products, a color temperature range from 3500K-2200K is controlled synchronously with intensity. Color consistency between fixtures is maintained to within 3 SDCM. LEDs are operated at reduced drive current to optimize efficacy and lumen maintenance. All LEDs have been tested in accordance with IESNA LM-80-08 and the results have shown L80 lumen maintenance greater than 60,000 hours. Absolute product photometry is measured and presented in accordance with IESNA LM-79, unless otherwise indicated.

Chromawerx SOLA

It is a single-channel control that dims output while warming the color temperature in a pre-determined relationship. A simple analog control sends a common signal to dual output digital drivers, which are programmed to adjust a specially populated LED array to emulate the effect of dimming a filament source. Dimming range is programmable but the default option runs from 3500K at 100% of full power to 2200K at 5% of full power. CRI is maintained above 80 throughout the dimming range.

Chromawerx DUO

It is a two-channel control. It uses an analog (0-10V) protocol for separate control of luminaire CCT and intensity or a digital (DMX, DALI and LD2) protocol for synchronous control of both warm and cool LED arrays to enable the user to set color temperature and light output. Commonly called "tunable white", Chromawerx two-channel control provides the range of cool (6500K) to warm (2700K) color that can be useful for helping to entrain circadian rhythms, stimulate alertness for improved educational and work productivity, and compensate for jet lag, among other applications. The Chromawerx drivers are programmed to limit maximum light output and power usage across all color temperatures. CRI is maintained above 80. When paired with DALI drivers (DDA/DDA8), color tuning follows a linear dimming curve.

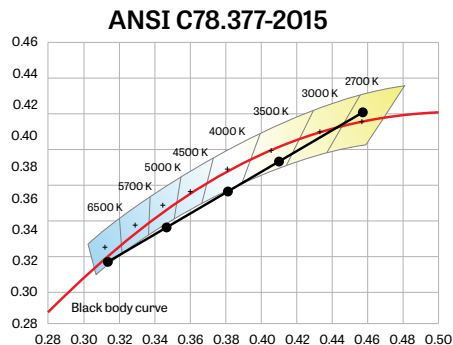

UBIK SEAL

RECESSED
CHROMAWERX - SOLA, DUO



WELL BUILDING STANDARD



WELL for Light: The WELL building standard focuses on light quality in several features. There are three categories that are fully attributed to the construction and features of a luminaire. In WELL V1, it's Feature 54 Circadian Lighting, Feature 55 Glare Control, and Feature 58 Color Quality. In WELL V2, it's Feature L03 Circadian Lighting, Feature L04 Glare Control, and Feature L07 Electric Light Quality.

This fixture meets Features:

- Feature 54 or L03 when DUO is selected
- Feature 55 or L04 meets WELL glare category (b-c-d)
- Feature 58 or L07 when 90+ CRI is selected

All LED drivers used at Lumenwerx are deemed to have a low risk level of flicker, of 5% or less below 90Hz operational as defined by IEEE standard 1789-2015 LED.



WELL for Mind: This luminaire meets WELL for mind as it is a human centric luminaire offering quality light, excellent color, and smooth optics. If any of these features are incorporated in a luminaire, it can improve the ability to focus, concentrate, and persist longer on a given task. This fixture harmoniously operates in a space to assist the mind.

For more information please contact well@lumenwerx.com.

LUMINAIRE LENGTH

Ubik is made up of standard 4' to 12' sections that may be joined together to create longer continuous run lengths. Exact run lengths must be noted in the product code. The minimum length is 4'. Lengths can be ordered in 1' increments.

All individual sections are joined together onsite using the joiner kits provided. Lumenwerx offers joiner kits that are extremely simple to work with in the field and result in a fixture that appears virtually seamless with no light leak at any connection.

ELECTRICAL

SOLA

SD1

Factory-set, adjustable output current LED driver with universal (120-277 VAC) input. Using a single 0-10V control signal, the light output warms in color temperature as it dims down to 1% and 2200K. At maximum driver load, efficiency<86%, PF>0.9, THD<20%.

DUO

DMX

Factory-set adjustable output current electronic driver with 120-277 VAC line input. Using DMX wall controls (optionally supplied by Lumenwerx) or an existing DMX control system, both channels of LEDs are independently adjustable. Each DMX driver can be independently addressed using the built-in RDM (Remote Device Management) in the field. Dimming down to 1% is attainable. Rated life (90% survivorship) of 50,000 hours at 50°C maximum ambient temperature. At maximum driver load, efficiency<84%, PF>0.9, THD<20%.

DALI

Factory-set adjustable output current electronic driver with 120-277 VAC line input. Using an existing DALI control system (supplied by others), one control channel adjusts the fixture color temperature, and the other control channel adjusts fixture brightness. With DALI Type 6, two DALI addresses are required to control both channels. With DALI Type 8, one DALI address is required to control both channels. Dimming down to 1% is attainable. Rated life (90% survivorship) of 50,000 hours at 50°C maximum ambient temperature. At maximum driver load, efficiency<84%, PF>0.9, THD<20%.

DD1

Factory-set adjustable output current LED driver with universal (120-277 VAC) input. Controlled via two individual 0-10V signals, one for setting light output down to a minimum of 1% and the other for adjusting the CCT (default range of 6500K-2700K). Rated life of 50,000 hours at 70°C maximum driver case temperature and 100% load conditions. Typical efficiency of 86%, PF>0.9, THD<20% at 100% load conditions.

LD2

Lutron DALI-2 digital drivers provide a high-performance tunable white solution with single-address digital control. Guaranteed performance and compatibility when used with Lutron DALI-2 controls.

PoE

Depending on the PoE manufacturer selected, Lumenwerx will install the node in factory as either integral to the luminaire or as a remote module. Factory programming of the PoE node may or may not enable the following functionalities: lumen package, DUO (tunable white), QUADRO (RGBW), emergency battery backup, and sensor integration. These must be addressed and evaluated on a case-by-case basis.

UBIK SEAL

RECESSED
CHROMAWERX - SOLA, DUO



MOUNTING

Recessed fixtures can be mounted into exposed or concealed T-bar or tegular ceiling, as well as in ceilings with trim, trimless, or mud flange options.

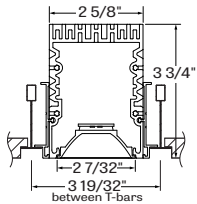

TG9 - Tegular 9/16"

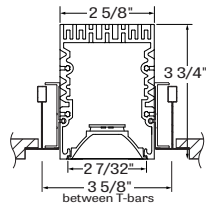

TG15 - Tegular 15/16"

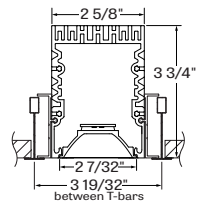

TB9 - T-bar 9/16"

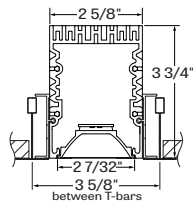

TB15 - T-bar 15/16"

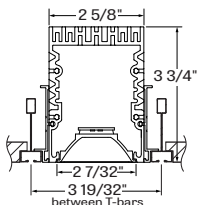

ST - Screw slot T-bar

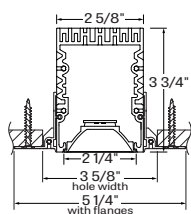

DMF - Drywall mud flange

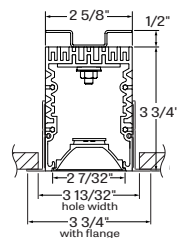

MTR - Trim

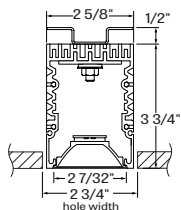

MTL - Trimless

CONSTRUCTION

- Housing:** Extruded aluminum, up to 90% recycled content
- Joiner bracket (MTL-MTR):** Cold drawn steel
- Joiner bracket (other):** Galvanised steel
- Louvers:** Injection molded optical grade polycarbonate, up to 95% reflective
- Parabolic heatsink:** Extruded aluminum, up to 90% recycled content
- End plate:** Aluminum sheet
- Gasket:** Closed-cell silicone foam gasket
- Grid gasket (GGK option):** 1/16" closed-cell silicone foam, assures a better seal between the fixture and the grid

FINISH

- Interior:** 95%, reflective matte powder coated white paint
- Exterior:** Powder-coat paint in matte white, matte black or aluminum. Optional antimicrobial finish, as well as custom finishes, also available.

WEIGHT

- 4':** 14.2 lbs - 6.4 kg
- 6':** 21.3 lbs - 9.7 kg
- 8':** 28.4 lbs - 12.9 kg
- 12':** 35.5 lbs - 16.1 kg

CERTIFICATIONS

- ETL:** IP54-Rated environment options are ETL Wet Listed. Conforms to UL Standard 1598 and certified to CAN/CSA Standard C22.2 No. 250.0. During the installation of Wet Listed fixtures, the contractor is responsible for properly sealing all mounting and electrical connection points.
- IC rated:** Suitable for direct contact with insulation
- Chicago Plenum:** City of Chicago approved (CCEA) when specified with CP option.

WARRANTY

Lumenwerx provides a five-year limited warranty on electrical and mechanical performance of the luminaires, including the LED boards, drivers, and auxiliary electronics. Lumenwerx will repair or replace defective luminaires or components at our discretion, provided they have been installed and operated in accordance with our specifications. Other limitations apply, please refer to the full warranty on our website. Wall controllers are covered by the manufacturer warranty.

DUO DMX SPECIFICATION

A qualified DMX integrator is required to assure proper installation and commissioning of the DMX network. **When placing the PO, please provide the contact information of your DMX integrator.**

Please answer the following questions to help us identify your DMX network requirements.

YES

Do you require a wall controller provided by Lumenwerx?

NO

DMX controller supplied by Lumenwerx

DMX control system supplied by others. Lumenwerx will supply DMX-enabled fixtures with default DMX addressing. See following pages for technical DMX informations.

How many zones do you have?
A zone consists of one or more luminaires behaving identically.

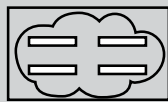

1 Zone



2 Zones

How to calculate the required number of drivers:

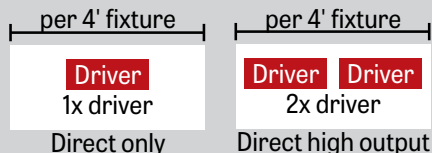

To Calculate # of drivers

1 - 4 Zones

5 or more Zones

Do you have more than 32 drivers in total?

NO

YES

Order a standard Lumenwerx wall controller.

WALL CONTROLLER

WCW - wall controller white
WCB - wall controller black

Add the control code at the end of your order code. Please provide a fixture layout or RCP (Reflected Ceiling Plan) showing the locations of the DMX fixtures, zones and the DMX wall controller. Refer to your DMX integrator for the installation.

Subject to factory evaluation. Please contact our controls specialist at controls@lumenwerx.com. Additional cost and equipment will be required.

Subject to factory evaluation and approval. Please contact our controls specialist at controls@lumenwerx.com. Additional cost and equipment will be required.

UBIK SEAL

RECESSED
CHROMAWERX - SOLA, DUO



GENERIC DMX NETWORK ARCHITECTURE

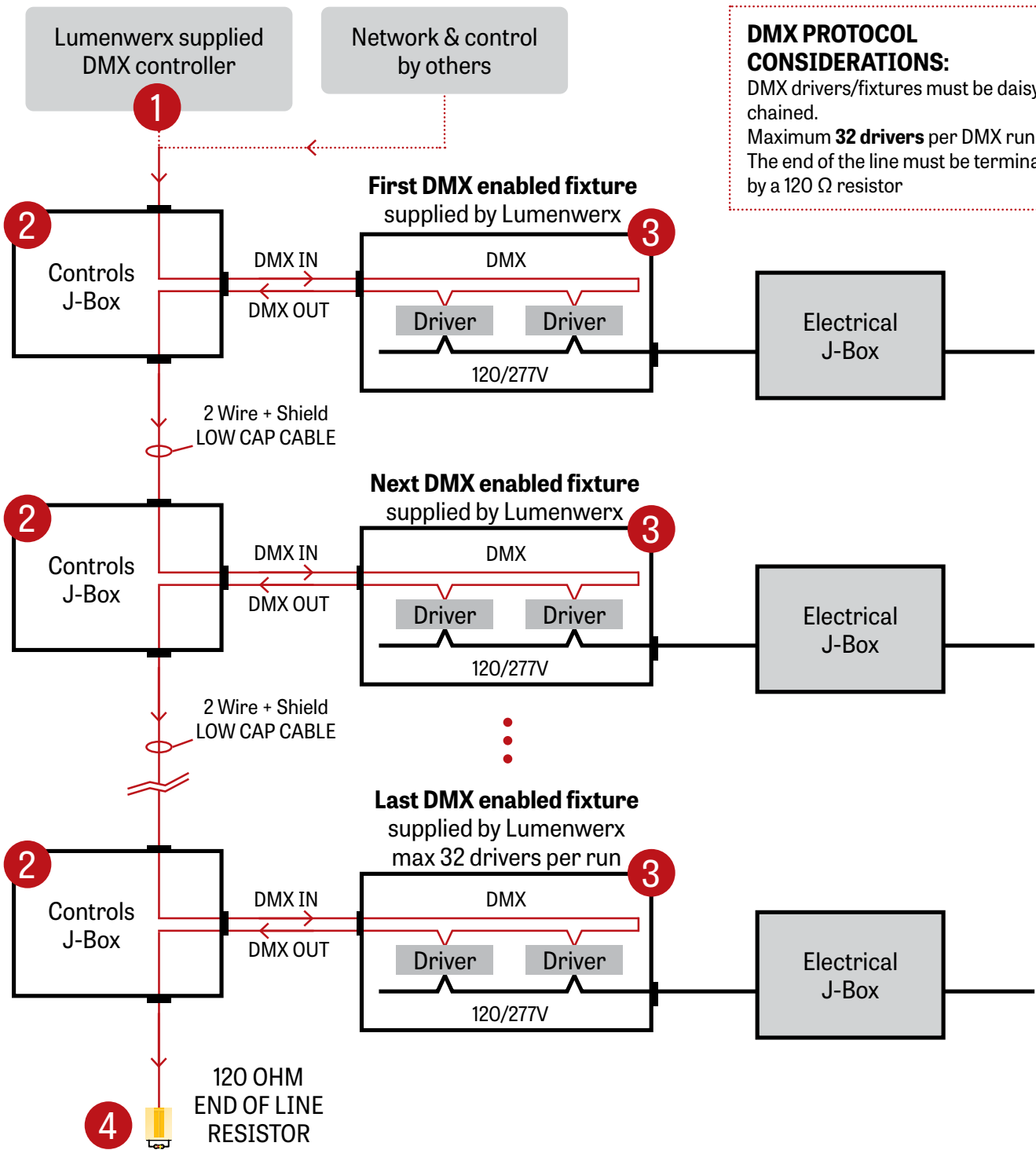

DMX PROTOCOL CONSIDERATIONS:
DMX drivers/fixtures must be daisy chained.
Maximum **32 drivers** per DMX run.
The end of the line must be terminated by a 120 Ω resistor

UBIK SEAL

RECESSED
CHROMAWERX - SOLA, DUO



1 LUMENWERX SUPPLIED DMX CONTROLLER

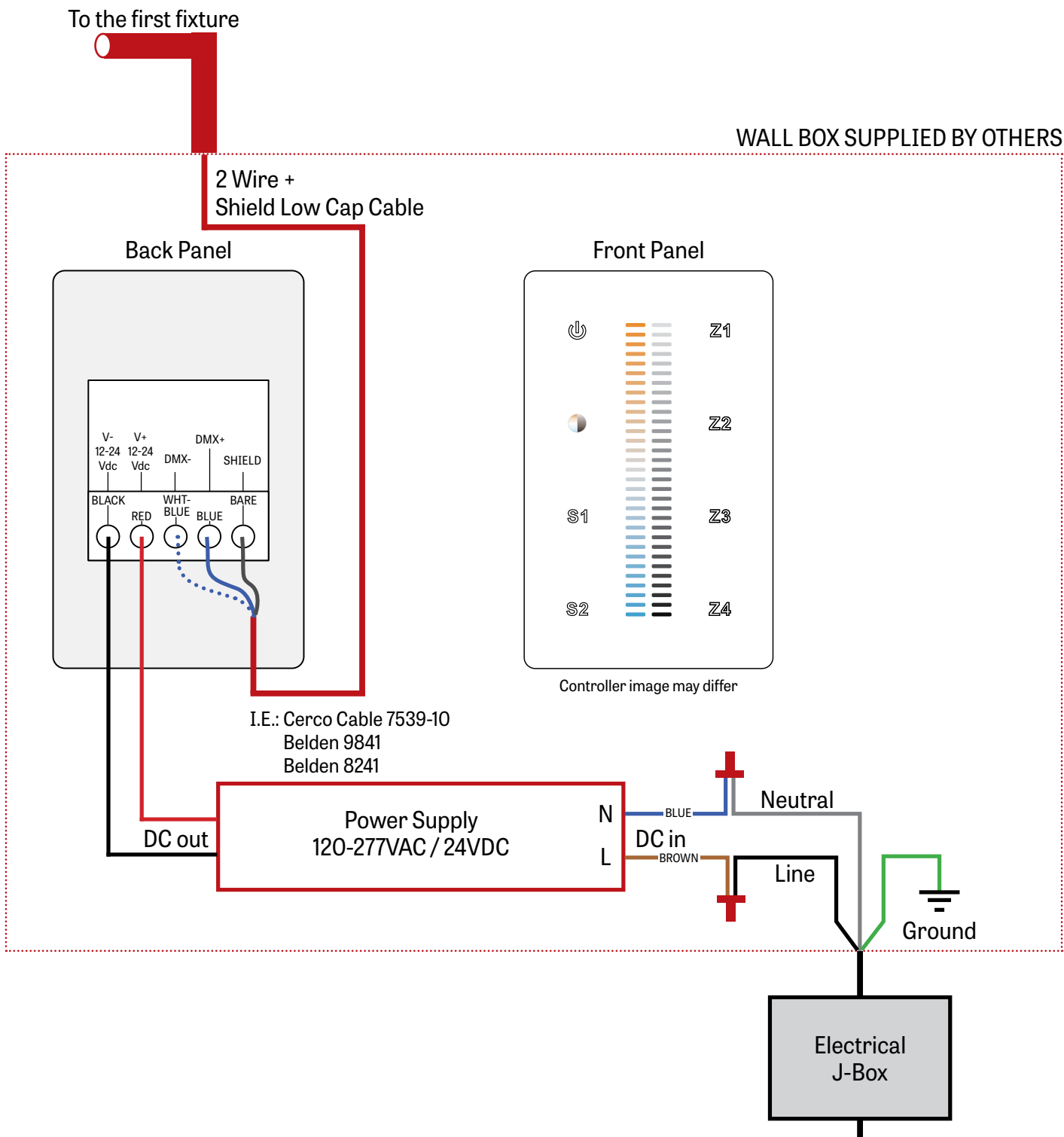

2 J-BOX DMX DAISY CHAIN DETAIL

Low capacitance DMX Cable from Previous Fixture

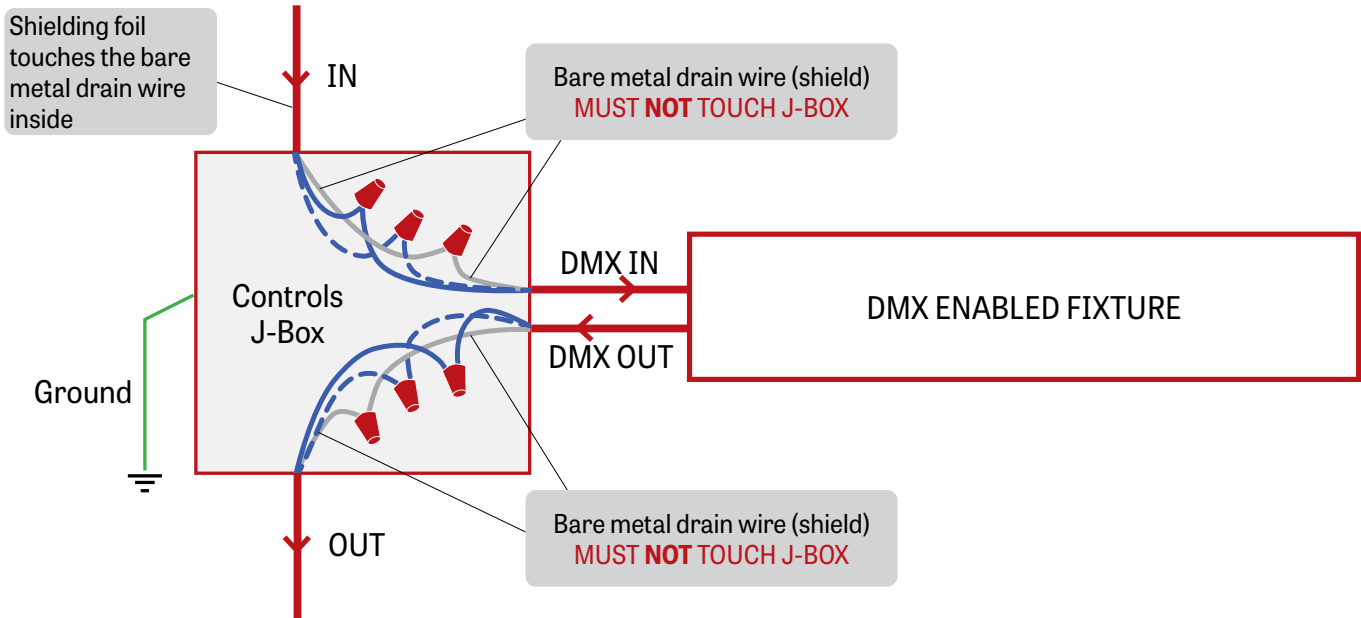

Low capacitance DMX cable to next fixture

3 DMX CONNECTION RECESSED & SURFACE

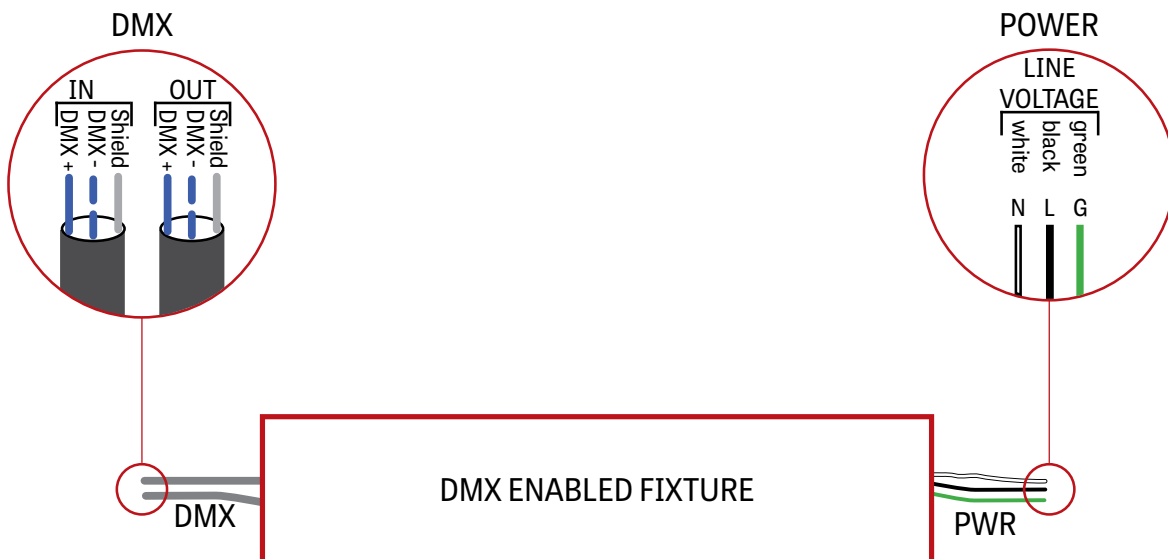

UBIK SEAL

RECESSED
CHROMAWERX - SOLA, DUO



4 DMX LAST FIXTURE DETAIL

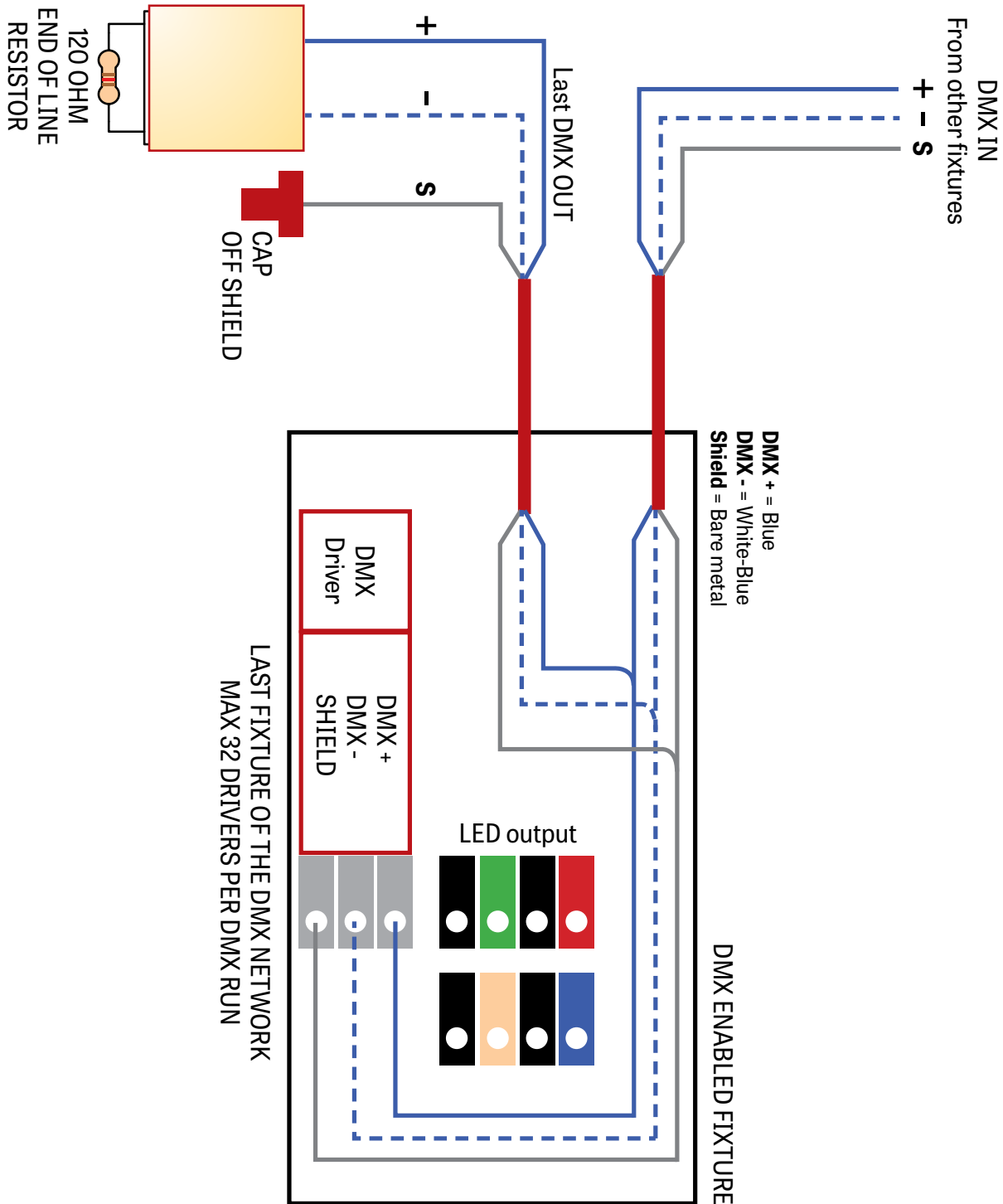

UBIK SEAL

RECESSED
CHROMAWERX - SOLA, DUO



DMX WALL CONTROLLER

DUO 1-4 ZONE

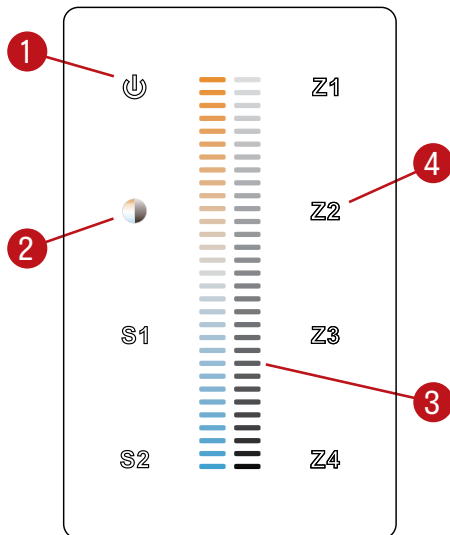

- (1) Power: Use this button to turn ON or OFF the fixture.
- (2) Brightness/CCT: Use the color/brightness toggle button to choose between color/brightness. When Blue: brightness is selected, when Yellow: color is selected.
- (3) Slider: Depending on the mode chosen in step 2, the slider will allow the user to set desired color or brightness.
- (4) Zone select: Up to 4 zones can be selected either independently or together. Once selected, the commands will be sent to the zone identified by a Blue LED.

Default DMX Addresses:

- 1 Warm
- 2 Cool

UBIK SEAL

RECESSED
CHROMAWERX - SOLA, DUO



DUAL 0-10V WALL CONTROLLER

Front Panel

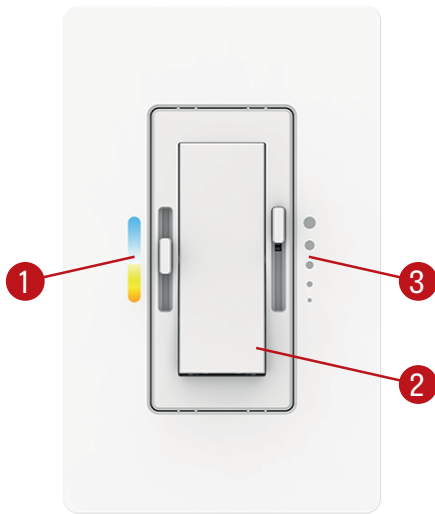

Controller image may differ

Dimensions

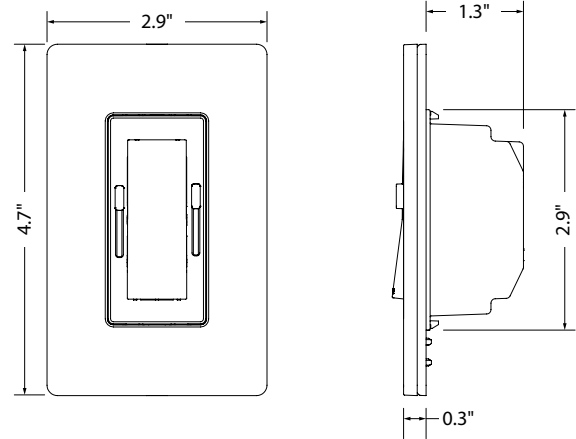

- (1) CCT control: Use this button to adjust the color temperature.
- (2) On/Off switch: Use this button to turn ON or OFF the fixture.
- (3) Dimming control: Use this button to adjust the brightness.

Wiring Diagram

