

VEGA

RECESSED
CHROMAWERX - QUADRO - RGBW

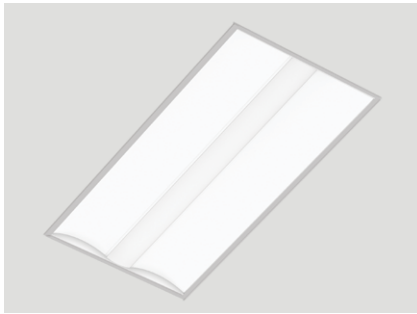

Project: _____
Type: _____



DESCRIPTION

Vega is an efficient architectural LED troffer with a distinctive luminous shielding that features a median textured optic. Using advanced LED engines, Vega provides highly efficient illumination and offers comprehensive ceiling, electrical, and controls options in 2'x2', 1'x4', and 2'x4' sizes. Vega is an ideal vehicle for Chromawerx color tuning in education, office, and healthcare applications where modular luminaires are used.

Order Guide

IC RATED



LUMINAIRE ID	SIZE	CENTER OPTIC	SIDE OPTIC	LIGHT SOURCE ¹	WHITE CRI Specify NA for solid colors	WHITE COLOR TEMP. Specify NA for solid colors
VEGR		MTO	HLO			
VEGR - Vega Recessed	1FTX4FT - 1' x 4' 2FTX2FT - 2' x 2' 2FTX4FT - 2' x 4'	MTO - Median Textured Optic	HLO - High-Efficiency Lambertian Optic	QUADRO - RGBW 4-channel control RS - Red solid GS - Green solid BS - Blue solid	80CRI - 80+ CRI 90CRI - 90+ CRI NA - Not applicable	27K - 2700K 30K - 3000K 35K - 3500K 40K - 4000K 50K - 5000K NA - Not applicable

¹Static white, full spectrum, Chromawerx SOLA, and DUO also available. Consult other spec sheets.

OUTPUT WATTAGE ²	VOLTAGE	DRIVER	ELECTRICAL	MOUNTING	FINISH	OPTIONS ⁶
			1C			
1' x 4' / 2' x 2' 20W - 20 W output 25W ³ - 25 W output 30W ³ - 30 W output	2' x 4' 120V - 120V 277V - 277V UNV - 120V-277V	QUADRO DMX ^{4,5} - DMX <u>Solid colors</u> D1 - 1% 0-10V DA ⁵ - DALI	1C - 1 circuit	TG9 - Tegular 9/16" TG15 - Tegular 15/16" TB9 - T-bar 9/16" TB15 - T-bar 15/16" ST - Screw slot T-bar DF - Drywall trim kit	W - Matte white AL - Aluminum B - Matte black CF# - Custom finish, specify RAL#	FU120 - Fuse 120V FU277 - Fuse 277V FWC - Flexible whip cable (6' std) AR ^{7,8} - Air return CP - Chicago Plenum NA - None

² See page 2 for dedicated white channel lumen outputs.
³ Not available with solid colors.

⁴ For more information, see pages 5 to 10.
⁵ On-site commissioning is required.

⁶ Separate codes with a "+" if more than one is specified.
⁷ For grid ceiling only.
⁸ Not available with 1' x 4'.

Accessories

Optional, order separately

DMX WALL CONTROLLER ^{9,10}

- WC1W##FT** - Single zone wall controller white
- WC1B##FT** - Single zone wall controller black
- WC2W##FT** - 3 zone wall controller white
- WC2B##FT** - 3 zone wall controller black

⁹ Specify wire length (##) in feet.
¹⁰ Available with DMX only. For more information, see pages 5 to 10, or consult factory.



RECESSED CHROMAWERX - QUADRO - RGBW

Dimensions (shown with 1' x 4')

GRID

SIZE	FIXTURE WIDTH A	WITH FLANGES B	BETWEEN T-BAR C	FIXTURE LENGTH D	WITH FLANGES E	BETWEEN T-BAR F
1' x 4'	11"	11 13/16"	12"	47"	47 13/16"	48"
2' x 2'	23"	23 13/16"	24"	23"	23 13/16"	24"
2' x 4'	23"	23 13/16"	24"	47"	47 13/16"	48"

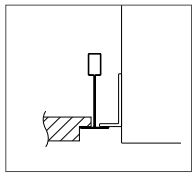
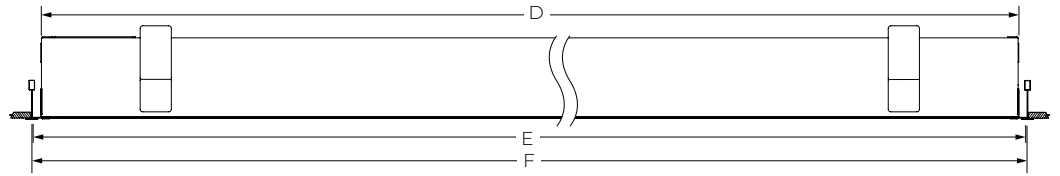
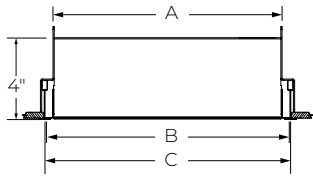

TC9
Regular 9/16"

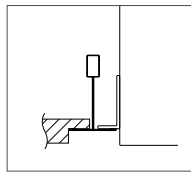

TG15
Regular 15/16"

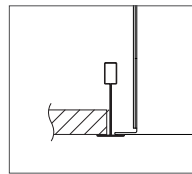

TB9
T-bar 9/16"

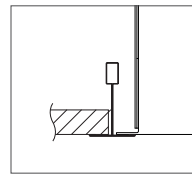

TB15
T-bar 15/16"

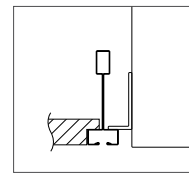

ST
Screw slot T-bar

DRYWALL TRIM KIT

SIZE	FIXTURE WIDTH A	CEILING CUT-OUT B	TRIM KIT WIDTH C	FIXTURE LENGTH D	CEILING CUT-OUT E	TRIM KIT LENGTH F
1' x 4'	11"	12 25/32"	13 3/8"	47"	48 25/32"	49 3/8"
2' x 2'	23"	24 25/32"	25 3/8"	23"	24 25/32"	25 3/8"
2' x 4'	23"	24 25/32"	25 3/8"	47"	48 25/32"	49 3/8"

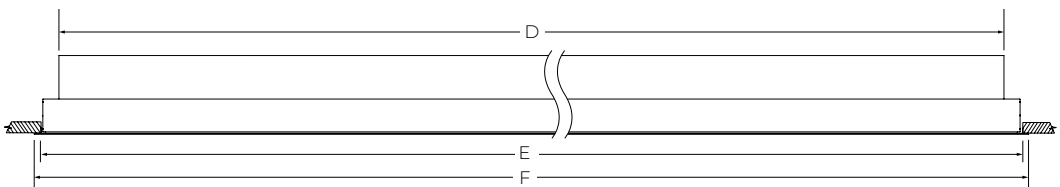
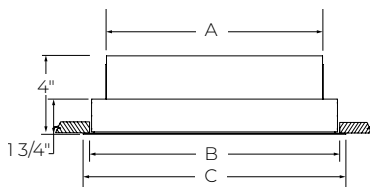

Photometrics

Dedicated white channel lumen outputs are calculated with only white light on, and based on 3500K and 90+ CRI.

1' x 4'		2' x 2'		2' x 4'	
W	LM	W	LM	W	LM
20	900	20	925	30	1550
25	1100	25	1150	40	2050
30	1300	30	1375	50	2550

RECESSED
CHROMAWERX - QUADRO - RGBW

Technical Specifications

OPTICS

Median Textured Optic (MTO)

Median Textured Optic (MTO) shielding consisting of ribbed diffusing center element.

High-Efficiency Lambertian Optic (HLO)

The High-Efficiency Lambertian Optic (HLO) uses matte white reflectors to distribute LED output across 0.075" acrylic shielding, providing up to 88% transmission and good obscuration.

LIGHT SOURCE

Custom array of mid-flux LEDs, comprised of an alternation of an RGB and a dedicated white LED. The white LED is used for when a static white CCT is required in the space. RGB LEDs are tightly binned for excellent color control between fixtures. The white LEDs have been tested in accordance with IESNA LM-80-08 and the results have shown L80 lumen maintenance greater than 60,000 hours. Absolute product photometry is measured and presented in accordance with IESNA LM-79, unless otherwise indicated.

Chromawerx QUADRO

Chromawerx QUADRO is a four-channel control that operates an RGBW LED array and addresses the need for more expressive color in architectural applications. The DMX driver supports familiar programming tools for both dynamic multi-hued color and precise white color point control. While a typical user interface will be a DMX controller by others, Lumenwerx also offers a simple control station for stand-alone color changing applications.

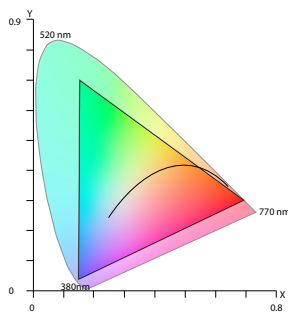

The above diagram overlays the full gamut of colors attainable with the RGBW on top of the CIE 1931 color space. Any color point inside of the triangle can be obtained by setting the correct output levels for each of the individual red, green, blue, and white channels.

ELECTRICAL

DMX

Factory-set, adjustable output current, multi-channel LED driver with universal (120-277 VAC) input. Using DMX wall controls (optionally supplied by Lumenwerx) or an existing DMX control system, four channels of LEDs (Red/Green/Blue/White) are independently adjustable. Each DMX driver has multiple output channels that can be independently addressed at the factory or on-site using built-in RDM (Remote Device Management) functionality. Dimming range from 100%-0%. At maximum driver load, efficiency < 89%, PF > 0.9, THD < 20%.

PoE

Depending on the PoE manufacturer selected, Lumenwerx will install the node in factory as either integral to the luminaire or as a remote module. Factory programming of the PoE node may or may not enable the following functionalities: lumen package, DUO (tunable white), QUADRO (RGBW), emergency battery backup, and sensor integration. These must be addressed and evaluated on a case-by-case basis.

MOUNTING

Recessed fixtures can be mounted into exposed or concealed T-bar or tegular ceiling, as well as in drywall ceilings with trim kit.

FINISH

Interior: 95%, reflective matte powder coated white paint

Exterior: Matte white, matte black or aluminum powder coating. Custom finishes are also available.

CONSTRUCTION

Housing: Die-formed cold rolled sheet steel

Reflectors: Die-formed cold rolled steel, 95% reflective matte white painted

Interior brackets: Die-formed cold rolled sheet steel

Center basket: Extruded aluminum

Lens: Acrylic

Drywall trim kit: Extruded aluminum

RECESSED CHROMAWERX - QUADRO - RGBW

WEIGHT

	Grid		Drywall trim kit	
1' x 4'	17.18 lbs	7.8 kg	20.26 lbs	9.2 kg
2' x 2'	16.08 lbs	7.3 kg	18.59 lbs	8.44 kg
2' x 4'	27.53 lbs	12.5 kg	31.27 lbs	14.2 kg

CERTIFICATIONS

ETL: Rated for indoor dry/damp locations. Conforms to UL Standard 1598 and certified to CAN/CSA Standard C22.2 No. 250.0.

Chicago Plenum: City of Chicago Approved (CCEA) when specified with CP option.

IC rated: Suitable for direct contact with insulation

WARRANTY

Lumenwerx provides a five-year limited warranty on electrical and mechanical performance of the luminaires, including the LED boards, drivers, and auxiliary electronics. Lumenwerx will repair or replace defective luminaires or components at our discretion, provided they have been installed and operated in accordance with our specifications. Other limitations apply, please refer to the full warranty on our website.

Wall controllers are covered by the manufacturer warranty.

RECESSED
CHROMAWERX - QUADRO - RGBW

QUADRO DMX SPECIFICATION

A qualified DMX integrator is required to assure proper installation and commissioning of the DMX network. **When placing the PO, please provide the contact information of your DMX integrator.**

Please answer the following questions to help us identify your DMX network requirements.

YES

Do you require a wall controller provided by Lumenwerx?

NO

DMX control system supplied by others. Lumenwerx will supply DMX-enabled fixtures with default DMX addressing. See following pages for technical DMX informations. ✓

DMX controller supplied by Lumenwerx

How many zones do you have?

A zone consists of one or more luminaires behaving identically.

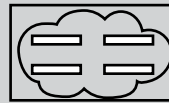

1 Zone



2 Zones

How to calculate the required number of drivers:

per 4' fixture
Driver
1x driver
Less than 12.5W/ft, direct only

per 4' fixture
Driver Driver
2x driver
Above 12.5W/ft or for all direct/indirect fixture

To Calculate # of drivers

1 Zone

2 to 3 Zones

4 or more Zones

Do you have more than 32 drivers in total?

NO

YES

Order a standard Lumenwerx wall controller type 1.

WALL CONTROLLER

WC1W - Single zone wall controller white
WC1B - Single zone wall controller black

Add the control code at the end of your order code.

Please provide a fixture layout or RCP (Reflected Ceiling Plan) showing the locations of the DMX fixtures, zones and the DMX wall controller.

Refer to your DMX integrator for the installation. ✓

Subject to factory evaluation. Please contact our controls specialist at controls@lumenwerx.com. Additional cost and equipment will be required. ✓

NO

YES

Order a standard Lumenwerx wall controller type 2.

WALL CONTROLLER

WC2W - 3 zone wall controller white
WC2B - 3 zone wall controller black

Add the control code at the end of your order code.

Please provide a fixture layout or RCP (Reflected Ceiling Plan) showing the locations of the DMX fixtures, zones and the DMX wall controller.

Refer to your DMX integrator for the installation. ✓

Subject to factory evaluation. Please contact our controls specialist at controls@lumenwerx.com. Additional cost and equipment will be required. ✓

Subject to factory evaluation and approval. Please contact our controls specialist at controls@lumenwerx.com. Additional cost and equipment will be required. ✓

GENERIC DMX NETWORK ARCHITECTURE

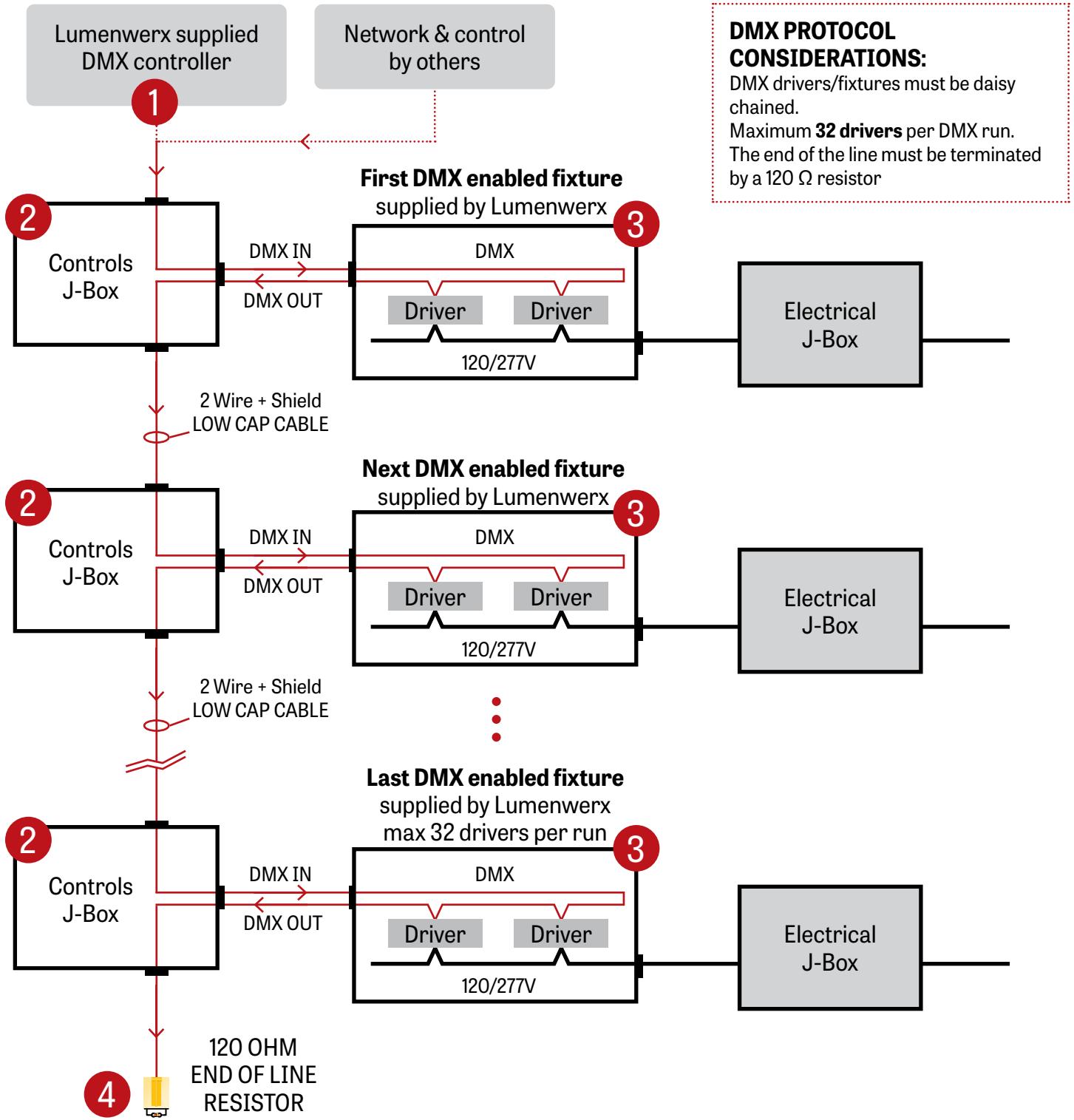

RECESSED
CHROMAWERX - QUADRO - RGBW

1 LUMENWERX SUPPLIED DMX CONTROLLER

To the first fixture

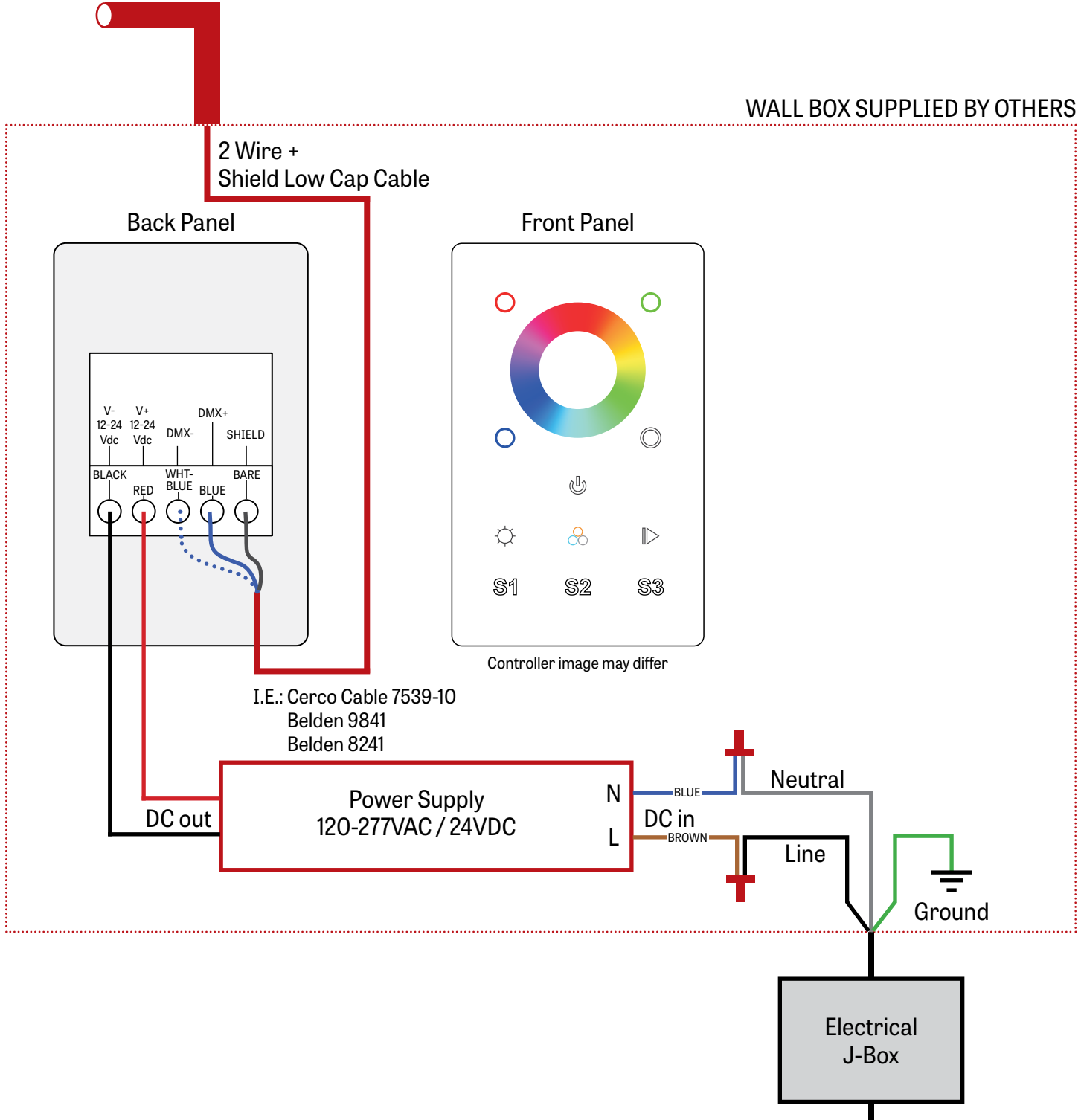

RECESSED
CHROMAWERX - QUADRO - RGBW

2 J-BOX DMX DAISY CHAIN DETAIL

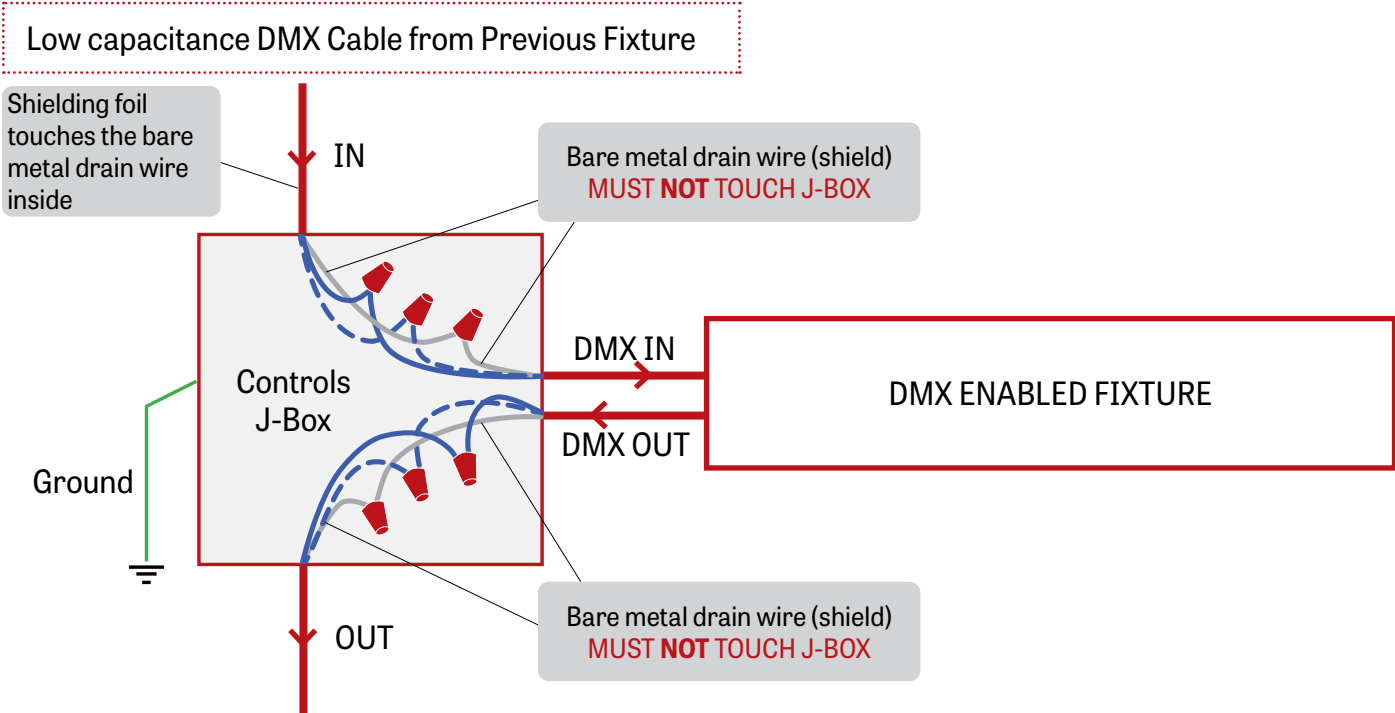

Low capacitance DMX cable to next fixture

3 DMX CONNECTION RECESSED & SURFACE

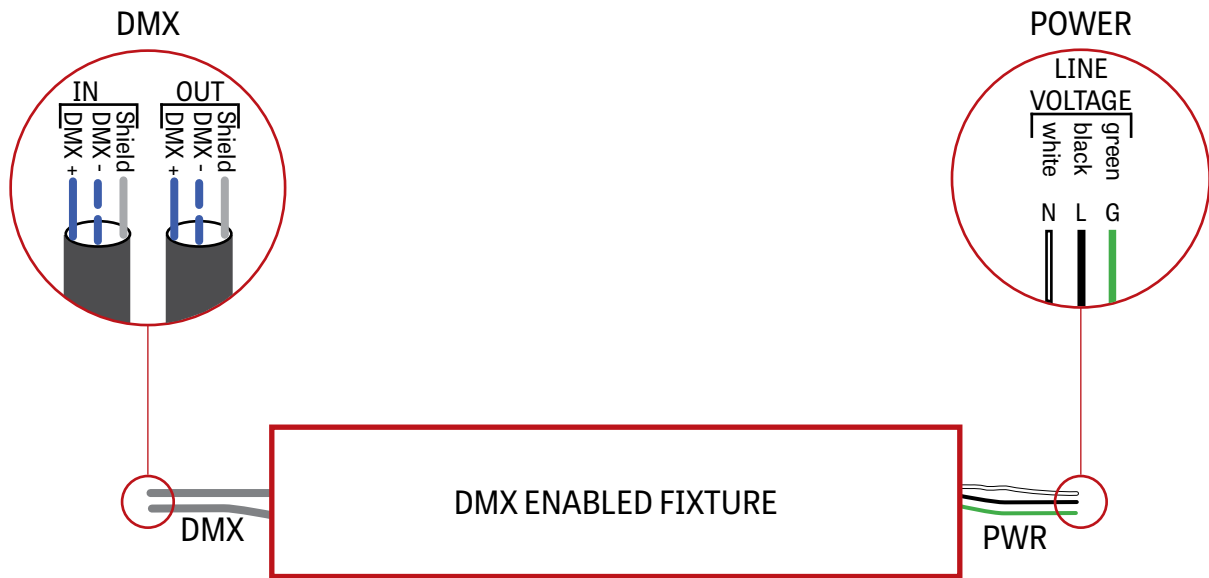

RECESSED
CHROMAWERX - QUADRO - RGBW

4 DMX LAST FIXTURE DETAIL

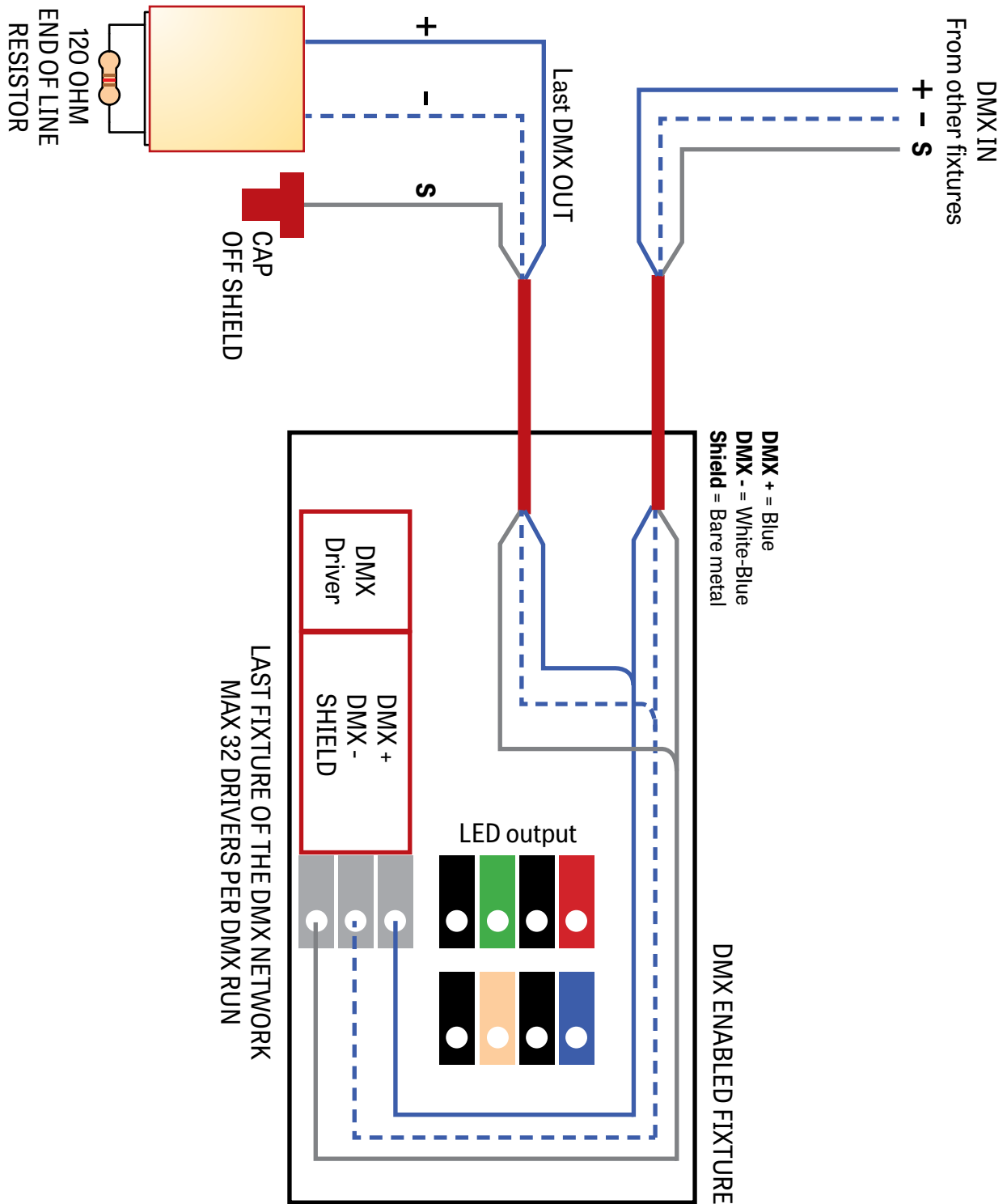

DMX WALL CONTROLLER

WC1

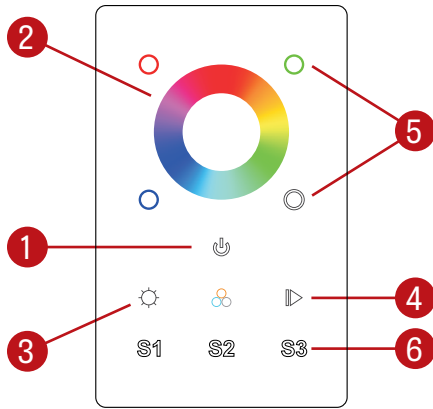

- (1) Power: Use this button to turn ON or OFF the RGBW fixture.
- (2) Color Wheel: The wheel is used to rapidly select a color (RGB colors only).
- (3) Brightness (RGB): Hold down this button to either increase or decrease the brightness of the current RGB selection. White will not be affected by the RGB brightness button.
- (4) Color Cycle: This button will start an animation, rotating between Reds Greens and Blues, the arrows allow the user to speed up or slow down the animation.
- (5) Individual Colors: By pressing and holding a color it will be possible to brighten or dim it. Quickly pressing a color will turn it OFF or turn it ON to its previous dim level.
White: In order to activate or deactivate and dim the White channel, the White button needs to be used.
- (6) Scenes: By holding down one of the scenes button, the current color selection is saved. It can be later accessed by quickly pressing on one of the Scene buttons.

WC2

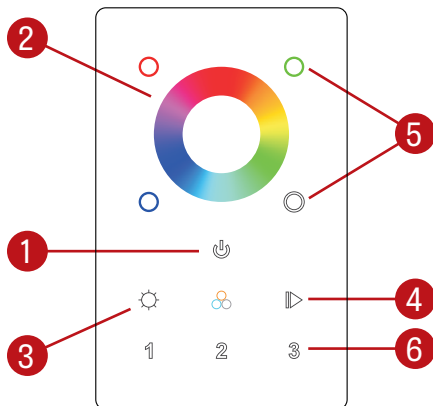

- (1) Power: Use this button to turn ON or OFF the RGBW fixture.
- (2) Color Wheel: The wheel is used to rapidly select a color (RGB colors only).
- (3) Brightness: Hold down this button to either increase or decrease the brightness of the current RGB selection. White will not be affected by the RGB brightness button.
- (4) Color Cycle: This button will start an animation, rotating between Reds Greens and Blues, the arrows allow the user to speed up or slow down the animation.
- (5) Individual Colors: By pressing a color it will be possible to brighten or dim that specific color.
White: In order to activate or deactivate and dim the White channel, the White button needs to be used.
- (6) Zone: By holding down one of the zone buttons, a zone can be selected and controlled.

Default DMX Addresses:

- 1 Red**
- 2 Green**
- 3 Blue**
- 4 White**