

VEGA

RECESSED
CHROMAWERX - SOLA, DUO



Project: _____

Type: _____

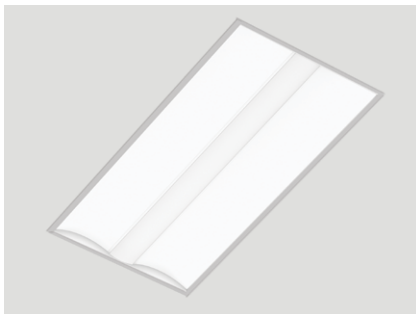

DESCRIPTION

Vega is an efficient architectural LED troffer with a distinctive luminous shielding that features a median textured optic. Using advanced LED engines, Vega provides highly efficient illumination and offers comprehensive ceiling, electrical, and controls options in 1'x4', 2'x2', and 2'x4' sizes. Vega is an ideal vehicle for Chromawerx white tuning in education, office, and healthcare applications where modular luminaires are used.



IC RATED

Order Guide

LUMINAIRE ID	SIZE	CENTER OPTIC	SIDE OPTIC	LIGHT SOURCE ¹	CRI	LUMEN PACKAGE			
VEGR		MTO	HLO						
VEGR - Vega Recessed	1FTX4FT - 1' x 4' 2FTX2FT - 2' x 2' 2FTX4FT - 2' x 4'	MTO - Median Textured Optic	HLO - High-Efficiency Lambertian Optic	SOLA - Dim-to-warm single channel control 35K to 22K DUO - Tunable white 2-channel control 65K to 27K ¹ Static white, full spectrum, and Chromawerx QUADRO also available. Consult other spec sheets.	80CRI - 80+ CRI 90CRI - 90+ CRI	Low	Medium	High	
						1' x 4'	2300LM - 2300 lm	3200LM - 3200 lm	4200LM - 4200 lm
						2' x 2'	2300LM - 2300 lm	3200LM - 3200 lm	4200LM - 4200 lm
						2' x 4'	4000LM - 4000 lm	5500LM - 5500 lm	6800LM - 6800 lm
VOLTAGE		DRIVER	ELECTRICAL	MOUNTING	FINISH	OPTIONS ⁴			
			1C						
120V - 120V 277V - 277V UNV - 120V-277V	<u>SOLA</u> SD1 - Single 0-10V input <u>DUO</u> DMX ^{2,3} - DMX DDA ³ - DALI DT6 DDA8 ³ - DALI DT8 DD1 - Dual 0-10V input for CCT/intensity LD2 ³ - Lutron DALI-2 digital ² For more information, see pages 6 to 11. ³ On-site commissioning is required.		1C - 1 circuit	TC9 - Tegular 9/16" TG15 - Tegular 15/16" TB9 - T-bar 9/16" TB15 - T-bar 15/16" ST - Screw slot T-bar DF - Drywall trim kit	W - Matte white AL - Aluminum B - Matte black CF# - Custom finish, specify RAL#	FU120 - Fuse 120V FU277 - Fuse 277V FWC - Flexible whip cable (6' std) AR ^{5,6} - Air return CP - Chicago Plenum NA - None ⁴ Separate codes with a "*" if more than one is specified. ⁵ For grid ceiling only. ⁶ Not available with 1' x 4'.			

Accessories

Optional, order separately

WALL CONTROLLER ⁷	
DMX	DD1
WCW##FT ⁸ - DMX wall controller white WCB##FT ⁸ - DMX wall controller black	TWCW##FT ^{9,10} - Dual 0-10V wall controller white TWCB##FT ^{9,10} - Dual 0-10V wall controller black

⁷Specify wire length (##) in feet.

⁸Available with DMX only. For more information, see pages 6 to 11, or consult factory.

⁹Available with DD1 only. For more information, see page 12, or consult factory.

¹⁰Only available with 120V.

Dimensions (shown with 1' x 4')

GRID

SIZE	FIXTURE WIDTH A	WITH FLANGES B	BETWEEN T-BAR C	FIXTURE LENGTH D	WITH FLANGES E	BETWEEN T-BAR F
1' x 4'	11"	11 13/16"	12"	47"	47 13/16"	48"
2' x 2'	23"	23 13/16"	24"	23"	25 13/16"	24"
2' x 4'	23"	23 13/16"	24"	47"	47 13/16"	48"

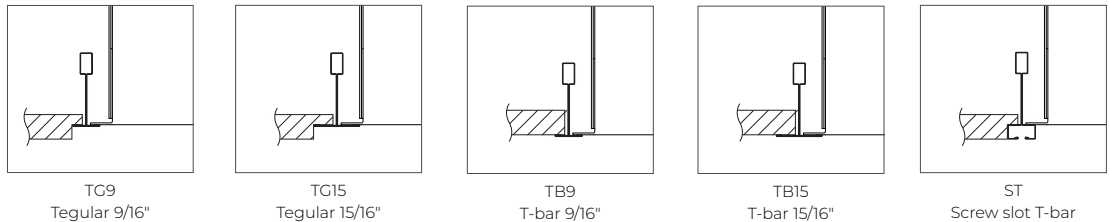
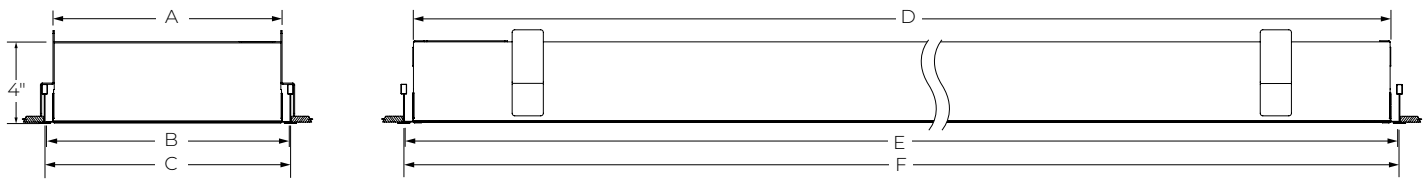

DRYWALL TRIM KIT

SIZE	FIXTURE WIDTH A	CEILING CUT-OUT B	TRIM KIT WIDTH C	FIXTURE LENGTH D	CEILING CUT-OUT E	TRIM KIT LENGTH F
1' x 4'	11"	12 25/32"	13 3/8"	47"	48 25/32"	49 3/8"
2' x 2'	23"	24 25/32"	25 3/8"	23"	24 25/32"	25 3/8"
2' x 4'	23"	24 25/32"	25 3/8"	47"	48 25/32"	49 3/8"

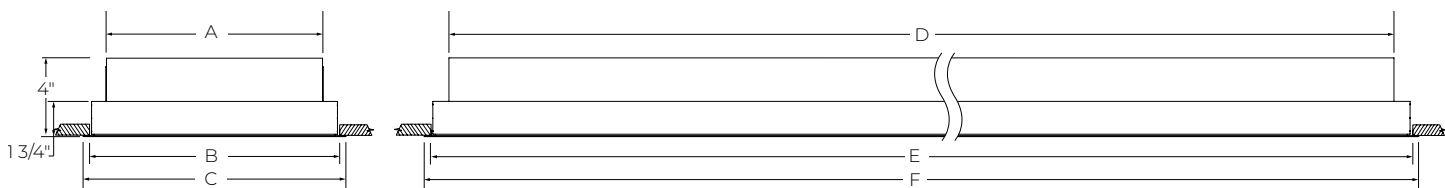

VEGA

RECESSED
CHROMAWERX - SOLA, DUO



Photometrics

Values calculated based on 3500K.

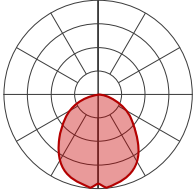

1' x 4'

LM	W	LM/W
2300	24	96
3200	34	95
4200	44	95

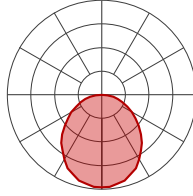

2' x 2'

LM	W	LM/W
2300	21	111
3200	30	106
4200	42	101

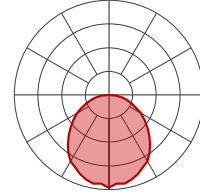

2' x 4'

LM	W	LM/W
4000	36	112
5500	50	111
6800	62	109

MULTIPLIER TABLE

Use the table to get results for different color temperatures.

SOLA

CCT	WATTS 80+ CRI / 90+ CRI	LPW 80+ CRI / 90+ CRI
3500K	1.00	1.00

DUO

CCT	WATTS 80+ CRI / 90+ CRI	LPW 80+ CRI / 90+ CRI
2700K	1.02	0.98
6500K	0.99	1.01

Technical Specifications

OPTICS

Median Textured Optic (MTO)

Median Textured Optic (MTO) shielding consisting of ribbed diffusing center element.

High-Efficiency Lambertian Optic (HLO)

The High-Efficiency Lambertian Optic (HLO) uses matte white reflectors to distribute LED output across 0.075" acrylic shielding, providing up to 88% transmission and good obscuration.

LIGHT SOURCE

Custom array of alternating color temperature mid-flux LEDs are mounted directly to the housing for optimal thermal performance. For the DUO products, a color temperature range from 6500K-2700K is achievable with color points on or below the black body curve. For the SOLA products, a color temperature range from 3500K-2200K is controlled synchronously with intensity. Color consistency between fixtures is maintained to within 3 SDCM. All LEDs have been tested in accordance with IESNA LM-80-08 and the results have shown L80 lumen maintenance greater than 60,000 hours. Absolute product photometry is measured and presented in accordance with IESNA LM-79, unless otherwise indicated.

Chromawerx SOLA

It is a single-channel control that dims output while warming the color temperature in a pre-determined relationship. A simple analog control sends a common signal to dual output digital drivers, which are programmed to adjust a specially populated LED array to emulate the effect of dimming a filament source. Dimming range is programmable but the default option runs from 3500K at 100% of full power to 2200K at 5% of full power. CRI is maintained above 80 throughout the dimming range.

Chromawerx DUO

It is a two-channel control. It uses an analog (0-10V) protocol for separate control of luminaire CCT and intensity or a digital (DMX, DALI, and LD2) protocol for synchronous control of both warm and cool LED arrays to enable the user to set color temperature and light output. Commonly called "tunable white", Chromawerx two-channel control provides the range of cool (6500K) to warm (2700K) color that can be useful for helping to entrain circadian rhythms, stimulate alertness for improved educational and work productivity, and compensate for jet lag, among other applications. The Chromawerx drivers are programmed to limit maximum light output and power usage across all color temperatures. CRI is maintained above 80. When paired with DALI drivers (DDA/DDA8), color tuning follows a linear dimming curve.

ANSI C78.377-2015

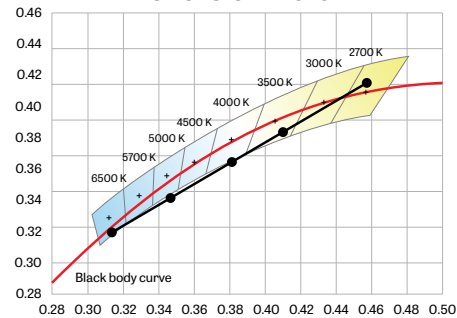

ELECTRICAL

SOLA

SDI

Factory-set, adjustable output current LED driver with universal (120-277 VAC) input. Using a single 0-10V control signal, the light output warms in color temperature as it dims down to 1% and 2200K. At maximum driver load, efficiency<86%, PF>0.9, THD<20%.

DUO

DMX

Factory-set adjustable output current electronic driver with 120-277 VAC line input. Using DMX wall controls (optionally supplied by Lumenwerx) or an existing DMX control system, both channels of LEDs are independently adjustable. Each DMX driver can be independently addressed using the built-in RDM (Remote Device Management) in the field. Dimming down to 1% is attainable. Rated life (90% survivorship) of 50,000 hours at 50°C maximum ambient temperature. At maximum driver load, efficiency<84%, PF>0.9, THD<20%.

DALI

Factory-set adjustable output current electronic driver with 120-277 VAC line input. Using an existing DALI control system (supplied by others), one control channel adjusts the fixture color temperature, and the other control channel adjusts fixture brightness. With DALI Type 6, two DALI addresses are required to control both channels. With DALI Type 8, one DALI address is required to control both channels. Dimming down to 1% is attainable. Rated life (90% survivorship) of 50,000 hours at 50°C maximum ambient temperature. At maximum driver load, efficiency<84%, PF>0.9, THD<20%.

VEGA

RECESSED CHROMAWERX - SOLA, DUO



DD1

Factory-set adjustable output current LED driver with universal (120-277 VAC) input. Controlled via two individual 0-10V signals, one for setting light output down to a minimum of 1% and the other for adjusting the CCT (default range of 6500K-2700K). Rated life of 50,000 hours at 70°C maximum driver case temperature and 100% load conditions. Typical efficiency of 86%, PF>0.9, THD<20% at 100% load conditions.

LD2

Lutron DALI-2 digital drivers provide a high-performance tunable white solution with single-address digital control. Guaranteed performance and compatibility when used with Lutron DALI-2 controls.

PoE

Depending on the PoE manufacturer selected, Lumenwerx will install the node in factory as either integral to the luminaire or as a remote module. Factory programming of the PoE node may or may not enable the following functionalities: lumen package, DUO (tunable white), QUADRO (RGBW), emergency battery backup, and sensor integration. These must be addressed and evaluated on a case-by-case basis.

MOUNTING

Recessed fixtures can be mounted into exposed or concealed T-bar or tegular ceiling, as well as in drywall ceilings with trim kit.

FINISH

Interior: 95%, reflective matte powder coated white paint
Exterior: Matte white, matte black or aluminum powder coating. Custom finishes are also available.

CONSTRUCTION

Housing: Die-formed cold rolled sheet steel
Reflectors: Die-formed cold rolled sheet steel, 95% reflective matte white painted
Interior brackets: Die-formed cold rolled sheet steel
Center basket: Extruded aluminum
Lens: Acrylic
Drywall trim kit: Extruded aluminum

WEIGHT

	Grid		Drywall trim kit	
1' x 4'	17.18 lbs	7.8 kg	20.26 lbs	9.2 kg
2' x 2'	16.08 lbs	7.3 kg	18.59 lbs	8.44 kg
2' x 4'	27.53 lbs	12.5 kg	31.27 lbs	14.2 kg

CERTIFICATIONS

ETL: Rated for indoor dry/damp locations. Conforms to UL Standard 1598 and certified to CAN/CSA Standard C22.2 No. 250.0.
Chicago Plenum: City of Chicago Approved (CCEA) when specified with CP option.
IC rated: Suitable for direct contact with insulation

WARRANTY

Lumenwerx provides a five-year limited warranty on electrical and mechanical performance of the luminaires, including the LED boards, drivers, and auxiliary electronics. Lumenwerx will repair or replace defective luminaires or components at our discretion, provided they have been installed and operated in accordance with our specifications. Other limitations apply, please refer to the full warranty on our website.
Wall controllers are covered by the manufacturer warranty.

DUO DMX SPECIFICATION

A qualified DMX integrator is required to assure proper installation and commissioning of the DMX network. **When placing the PO, please provide the contact information of your DMX integrator.**

Please answer the following questions to help us identify your DMX network requirements.

YES

Do you require a wall controller provided by Lumenwerx?

NO

DMX controller supplied by Lumenwerx

DMX control system supplied by others. Lumenwerx will supply DMX-enabled fixtures with default DMX addressing. See following pages for technical DMX informations.

How many zones do you have?

A zone consists of one or more luminaires behaving identically.



1 Zone



2 Zones

How to calculate the required number of drivers:

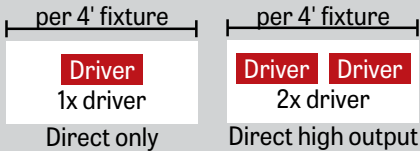

To Calculate # of drivers

1 - 4 Zones

5 or more Zones

Do you have more than 32 drivers in total?

NO

YES

Order a standard Lumenwerx wall controller.

WALL CONTROLLER

WCW - wall controller white
WCB - wall controller black

Add the control code at the end of your order code. Please provide a fixture layout or RCP (Reflected Ceiling Plan) showing the locations of the DMX fixtures, zones and the DMX wall controller. Refer to your DMX integrator for the installation.

Subject to factory evaluation. Please contact our controls specialist at controls@lumenwerx.com. Additional cost and equipment will be required.

Subject to factory evaluation and approval. Please contact our controls specialist at controls@lumenwerx.com. Additional cost and equipment will be required.

GENERIC DMX NETWORK ARCHITECTURE

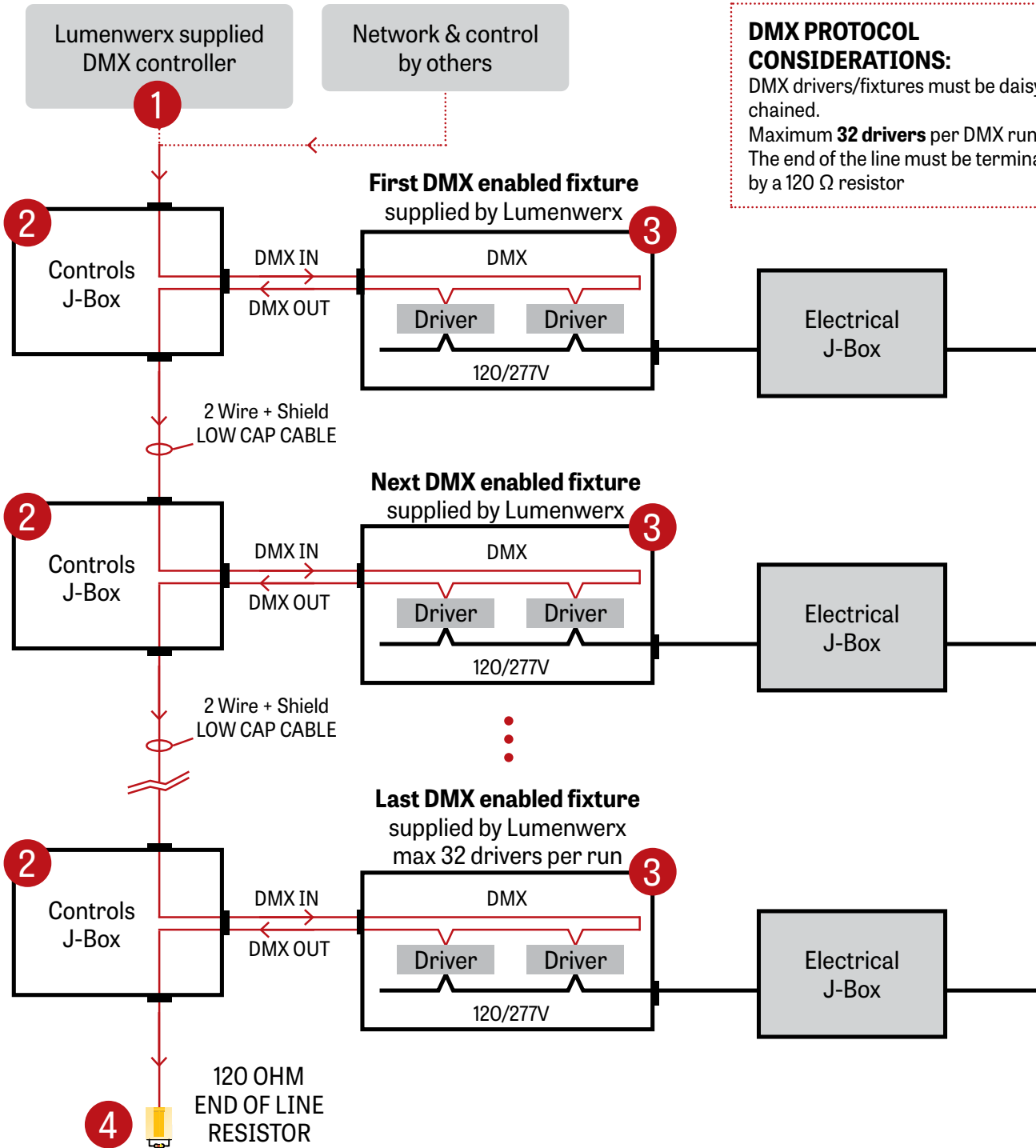

DMX PROTOCOL CONSIDERATIONS:
DMX drivers/fixtures must be daisy chained.
Maximum **32 drivers** per DMX run.
The end of the line must be terminated by a 120 Ω resistor

1 LUMENWERX SUPPLIED DMX CONTROLLER

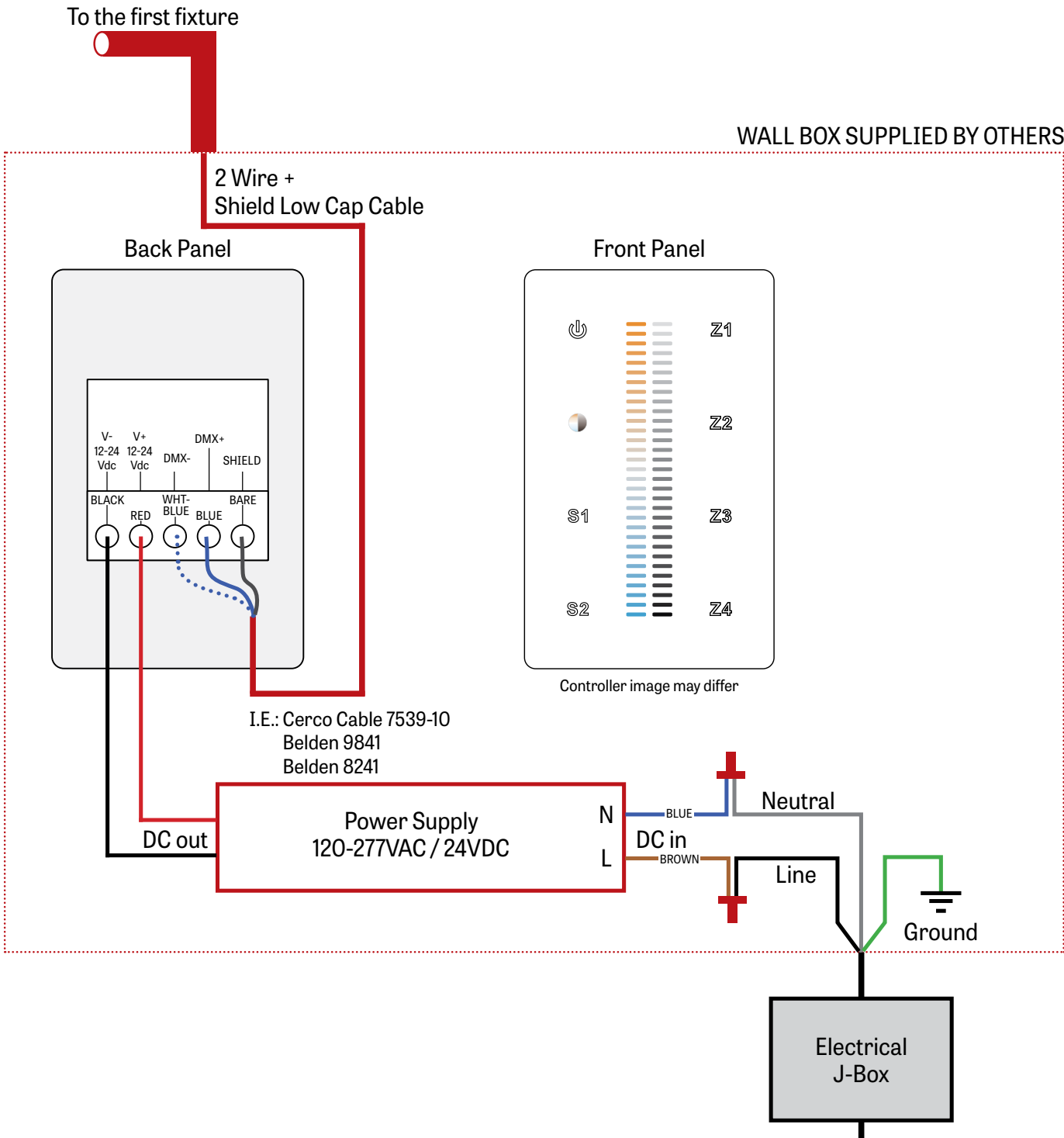

2 J-BOX DMX DAISY CHAIN DETAIL

Low capacitance DMX Cable from Previous Fixture

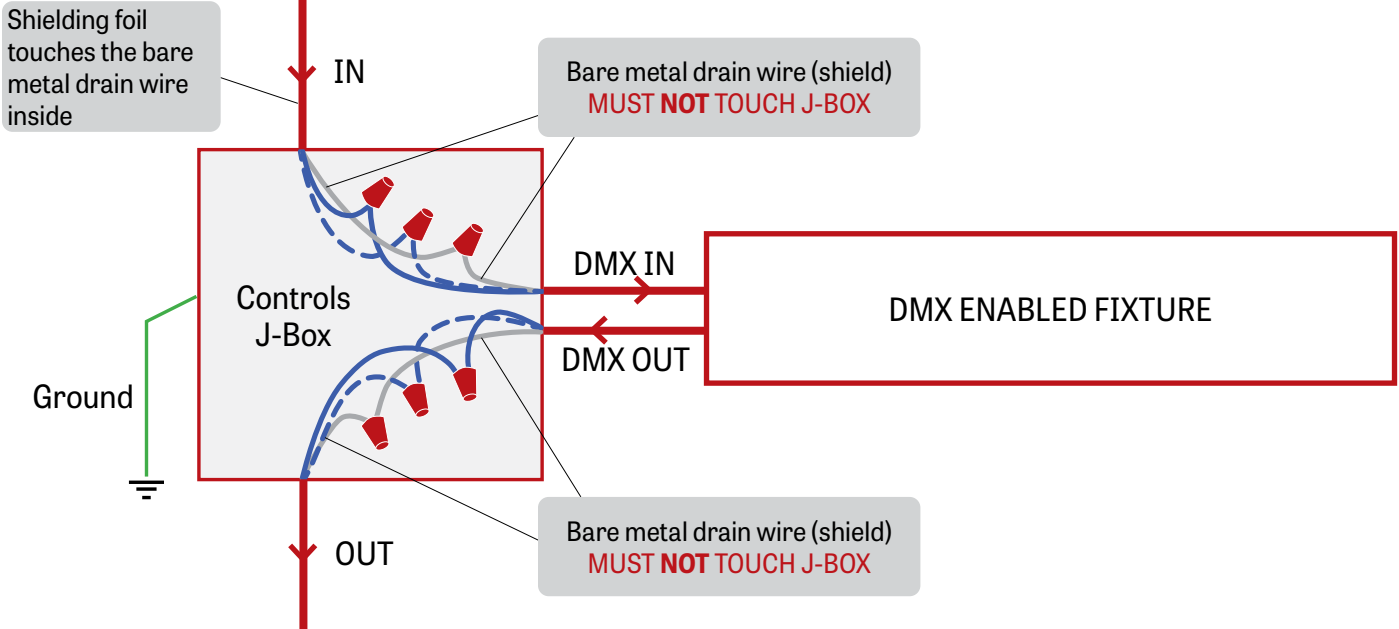

Low capacitance DMX cable to next fixture

3 DMX CONNECTION RECESSED & SURFACE

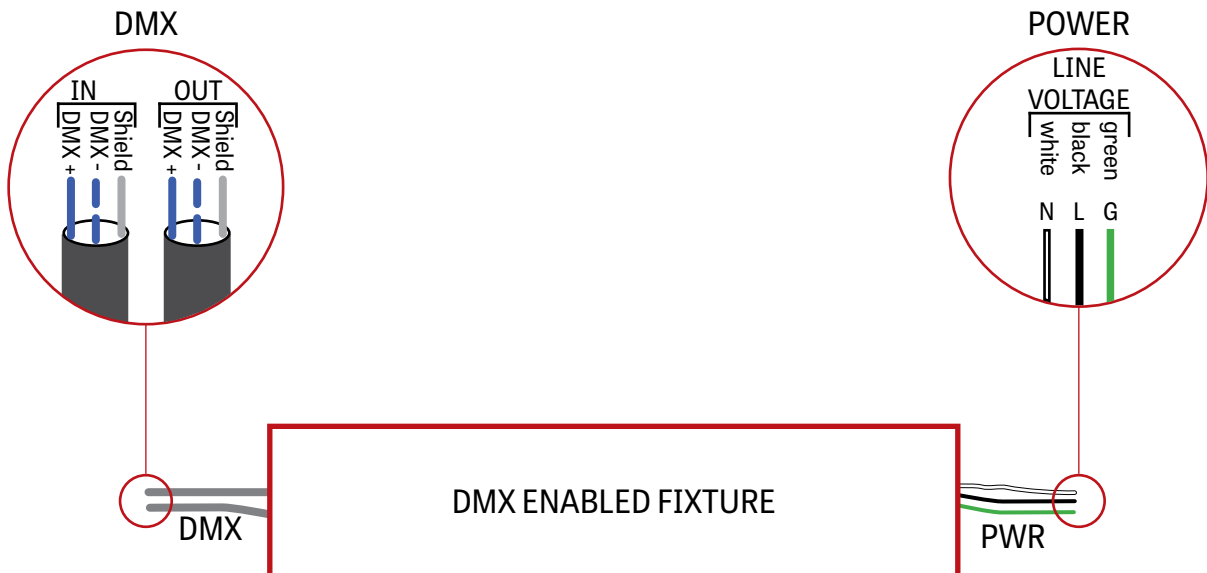

4 DMX LAST FIXTURE DETAIL

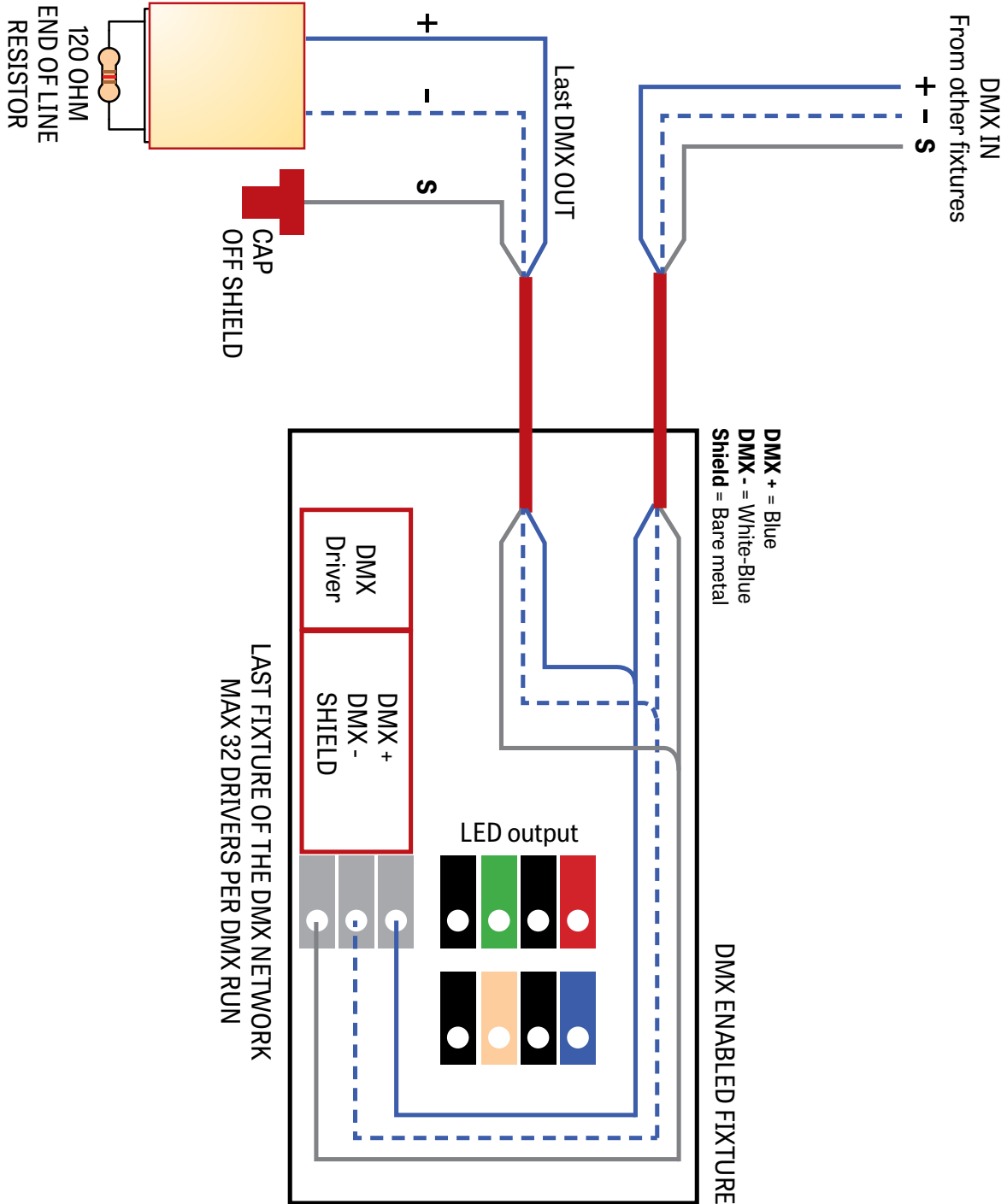

DMX WALL CONTROLLER

DUO 1-4 ZONE

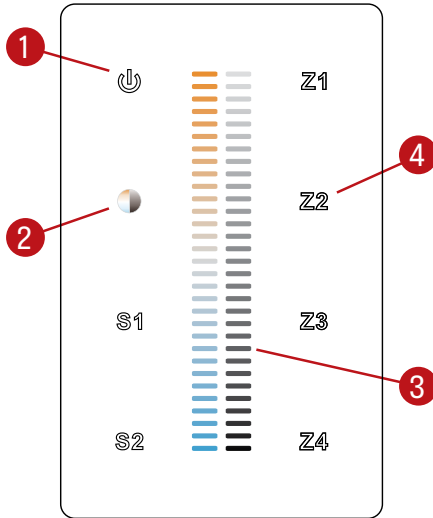

- (1) Power: Use this button to turn ON or OFF the fixture.
- (2) Brightness/CCT: Use the color/brightness toggle button to choose between color/brightness. When Blue: brightness is selected, when Yellow: color is selected.
- (3) Slider: Depending on the mode chosen in step 2, the slider will allow the user to set desired color or brightness.
- (4) Zone select: Up to 4 zones can be selected either independently or together. Once selected, the commands will be sent to the zone identified by a Blue LED.

Default DMX Addresses:

- 1 Warm
- 2 Cool

DUAL 0-10V WALL CONTROLLER

Front Panel

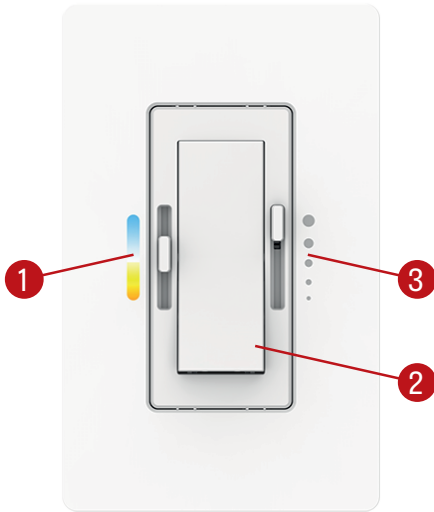

Controller image may differ

Dimensions

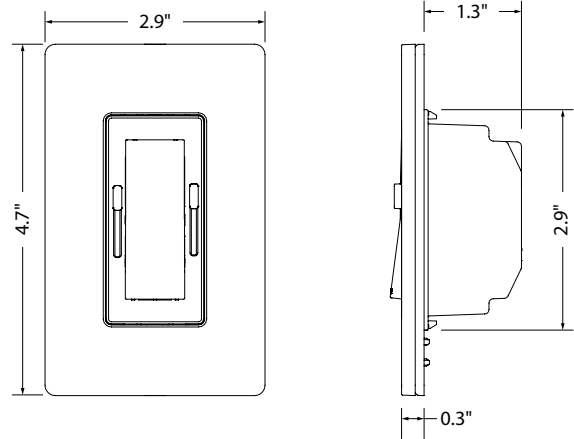

- (1) CCT control: Use this button to adjust the color temperature.
- (2) On/Off switch: Use this button to turn ON or OFF the fixture.
- (3) Dimming control: Use this button to adjust the brightness.

Wiring Diagram

