

VIA 1.5 & 2

ACOUSTIX - BLANK

LUMENWERX

Project: _____

Type: _____



Section View

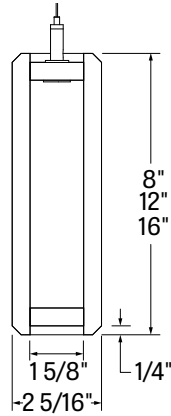

Via 1.5 Acoustix Blank

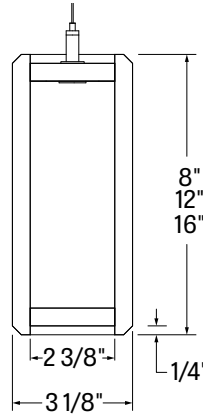

Via 2 Acoustix Blank

The Via 1.5 and Via 2 Acoustix Blank offer the same great construction as the lit versions. Via 1.5 and Via 2 Acoustix Blank act as additional sound absorption to add acoustical performance without over lighting the space and not compromising architectural aesthetics.

Order Guide

LUMINAIRE ID	LUMINAIRE LENGTH	LUMINAIRE HEIGHT	NON-POWERED MOUNTING
VIA1.5ACOBP - Via 1.5 Acoustix Blank Pendant VIA2ACOBP - Via 2 Acoustix Blank Pendant	Standard individual sections (nominal length): 4', 6', 8' #FT ¹ - Specify nominal length (#) ¹ Consult factory for other lengths.	8 - 8 inches 12 - 12 inches 16 - 16 inches	53WAC36 - 36" aircraft cable, white canopies (5" + 3" non-power) 55WSW18 - 18" white stem, white canopies (5" + 5" non-power)

FIXTURE FINISH	FELT COLOR	OPTIONS																																		
W W - Matte white	<table border="0"> <tr> <td>STANDARD COLORS</td> <td>PREMIUM COLORS^{2,3}</td> </tr> <tr> <td> <table border="0"> <tr> <td> FWN</td> <td> LVN</td> </tr> <tr> <td> FON</td> <td> LEN</td> </tr> <tr> <td> ION</td> <td> CYN</td> </tr> <tr> <td> TBN</td> <td> PMN</td> </tr> <tr> <td> MDN</td> <td> FGN</td> </tr> </table> </td> <td> <table border="0"> <tr> <td> PKN</td> <td> CDN</td> <td> IVN</td> <td> BHN</td> </tr> <tr> <td> OGN</td> <td> LCN</td> <td> SLN</td> <td> CFN</td> </tr> <tr> <td> LNN</td> <td> SYN</td> <td> CNN</td> <td> GRN</td> </tr> <tr> <td> LMN</td> <td> BLN</td> <td> GHN</td> <td> MON</td> </tr> <tr> <td> EGN</td> <td> NVN</td> <td> CLN</td> <td> ESN</td> </tr> </table> </td> </tr> </table>	STANDARD COLORS	PREMIUM COLORS^{2,3}	<table border="0"> <tr> <td> FWN</td> <td> LVN</td> </tr> <tr> <td> FON</td> <td> LEN</td> </tr> <tr> <td> ION</td> <td> CYN</td> </tr> <tr> <td> TBN</td> <td> PMN</td> </tr> <tr> <td> MDN</td> <td> FGN</td> </tr> </table>	FWN	LVN	FON	LEN	ION	CYN	TBN	PMN	MDN	FGN	<table border="0"> <tr> <td> PKN</td> <td> CDN</td> <td> IVN</td> <td> BHN</td> </tr> <tr> <td> OGN</td> <td> LCN</td> <td> SLN</td> <td> CFN</td> </tr> <tr> <td> LNN</td> <td> SYN</td> <td> CNN</td> <td> GRN</td> </tr> <tr> <td> LMN</td> <td> BLN</td> <td> GHN</td> <td> MON</td> </tr> <tr> <td> EGN</td> <td> NVN</td> <td> CLN</td> <td> ESN</td> </tr> </table>	PKN	CDN	IVN	BHN	OGN	LCN	SLN	CFN	LNN	SYN	CNN	GRN	LMN	BLN	GHN	MON	EGN	NVN	CLN	ESN	TB# - T-bar caddy clip, specify grid size TG# - Tegular caddy clip, specify grid size ST - Screw slots caddy clip CU - Custom
STANDARD COLORS	PREMIUM COLORS^{2,3}																																			
<table border="0"> <tr> <td> FWN</td> <td> LVN</td> </tr> <tr> <td> FON</td> <td> LEN</td> </tr> <tr> <td> ION</td> <td> CYN</td> </tr> <tr> <td> TBN</td> <td> PMN</td> </tr> <tr> <td> MDN</td> <td> FGN</td> </tr> </table>	FWN	LVN	FON	LEN	ION	CYN	TBN	PMN	MDN	FGN	<table border="0"> <tr> <td> PKN</td> <td> CDN</td> <td> IVN</td> <td> BHN</td> </tr> <tr> <td> OGN</td> <td> LCN</td> <td> SLN</td> <td> CFN</td> </tr> <tr> <td> LNN</td> <td> SYN</td> <td> CNN</td> <td> GRN</td> </tr> <tr> <td> LMN</td> <td> BLN</td> <td> GHN</td> <td> MON</td> </tr> <tr> <td> EGN</td> <td> NVN</td> <td> CLN</td> <td> ESN</td> </tr> </table>	PKN	CDN	IVN	BHN	OGN	LCN	SLN	CFN	LNN	SYN	CNN	GRN	LMN	BLN	GHN	MON	EGN	NVN	CLN	ESN					
FWN	LVN																																			
FON	LEN																																			
ION	CYN																																			
TBN	PMN																																			
MDN	FGN																																			
PKN	CDN	IVN	BHN																																	
OGN	LCN	SLN	CFN																																	
LNN	SYN	CNN	GRN																																	
LMN	BLN	GHN	MON																																	
EGN	NVN	CLN	ESN																																	

² Please consult factory for more color options.
³ Lead time may vary.

VIA 1.5 & 2

ACOUSTIX - BLANK

LUMENWERX

Project: _____

Type: _____

Standard Color Options



FWN - FROST WHITE

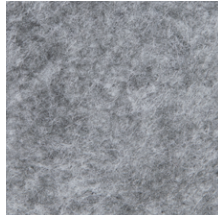

FON - FOG

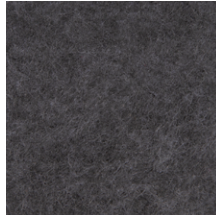

ION - IRON



TBN - TRUE BLACK



MDN - MIDNIGHT BLUE



LVN - LAVENDER



LEN - LATTE



CYN - CHERRY



PMN - PLUM

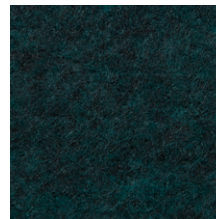

FGN - FOREST GREEN

Premium Color Options*



PKN - PAPRIKA



OGN - ORANGE



LNN - LEMON



LMN - LIME



EGN - EVERGREEN



CDN - CLOUDY



LCN - LICHEN

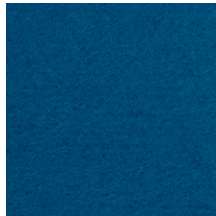

SYN - SKY



BLN - BLUEBERRY



NVN - NAVY



IVN - IVORY



SLN - STEEL



CNN - CARBON

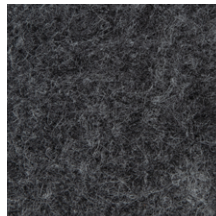

GHN - GRAPHITE

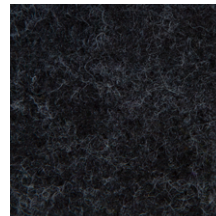

CLN - CHARCOAL



BHN - BLUSH



CFN - CAFÉ



GRN - GREIGE



MON - MOCHA



ESN - ESPRESSO

*Please consult factory for more color options.
*Lead time may vary.

VIA 1.5 & 2

ACOUSTIX - BLANK

LUMENWERX

Project: _____

Type: _____

DIMENSIONS

Via 1.5 Acoustix Blank Pendant

Front view

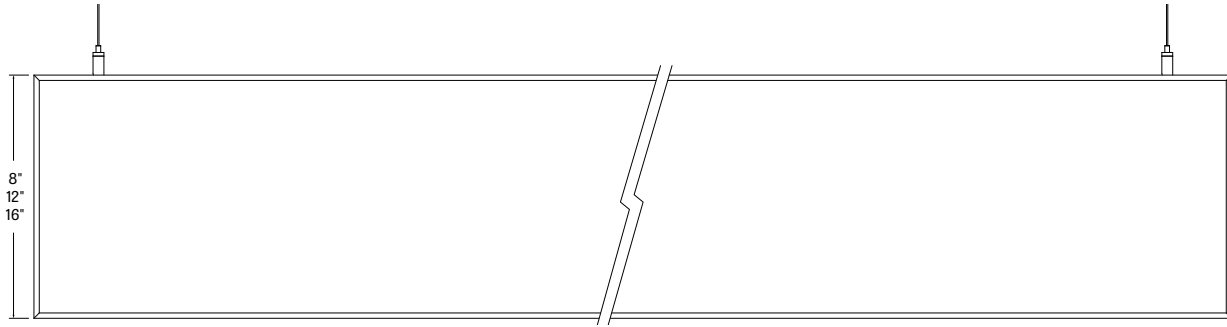

Side view

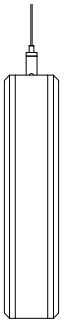

Bottom view

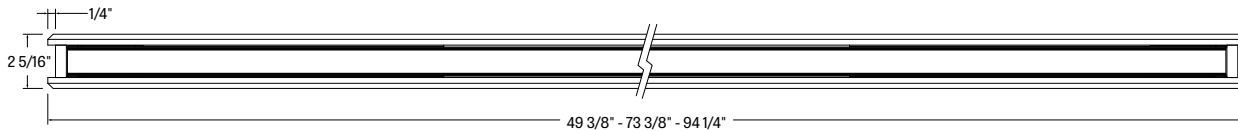

Via 2 Acoustix Blank Pendant

Front view

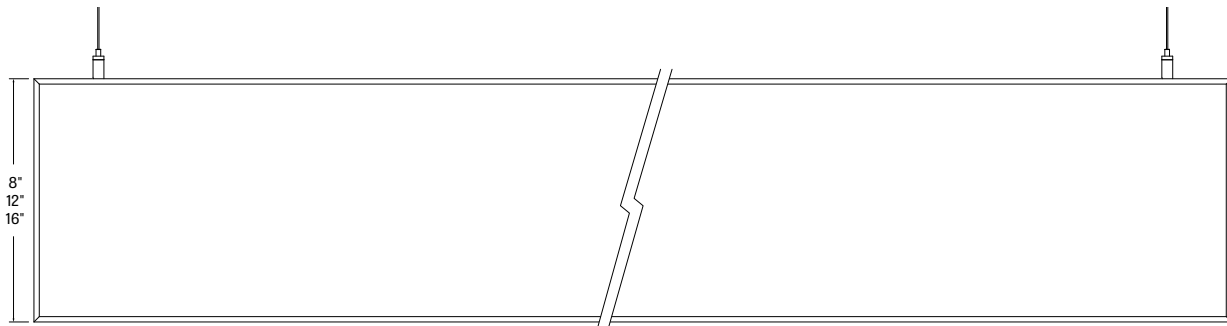

Side view

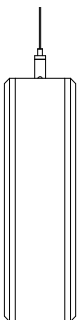

Bottom view

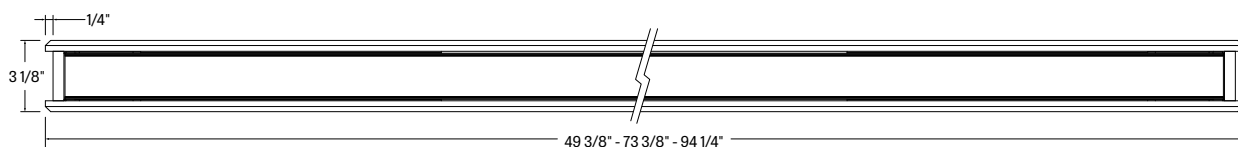

VIA 1.5 & 2

ACOUSTIX - BLANK

LUMENWERX

Project: _____

Type: _____

ACOUSTIC CALCULATOR

Using the Lumenwerx Acoustix Value Calculator table, you can determine the number of acoustic luminaires required in a space by fixture type. We have three levels of recommended sound reduction: good, better, and best. Choosing one of these options will reduce the sound accordingly. The best option indicates the best acoustic improvement. Calculations are based on a standard ceiling height of 9 feet.



- 1 Calculate the square feet of your room (L x W).
- 2 Choose the level of acoustical improvement you are looking for, and find the corresponding value based on your room dimension and luminaire configuration.

% in reduction in reverberation time		
😊	GOOD	25%
😊😊	BETTER	40%
😊😊😊	BEST	50%

LENGTH	HEIGHT	Room dimensions under 300 sq ft			Room dimensions over 300 sq ft		
		GOOD 😊	BETTER 😊😊	BEST 😊😊😊	GOOD 😊	BETTER 😊😊	BEST 😊😊😊
4 Feet	8"	19	9	6	29	15	10
	12"	29	14	8	45	22	14
	16"	38	19	12	58	29	19
6 Feet	8"	28.5	13.5	9	43.5	22.5	15
	12"	43.5	21	12	67.5	33	21
	16"	57	28.5	18	87	43.5	28.5
8 Feet	8"	38	18	12	58	30	20
	12"	58	28	16	90	44	28
	16"	76	38	24	116	58	38

- 3 Use the Lumenwerx Acoustix Value Formula to determine the number of luminaires needed in the room.

$$\text{Square feet} \div \text{Value} = \text{Number of luminaires}$$

Example:

Luminaires: Via 1.5 or Via 2 Acoustix, 4 ft long, 16" high
Room square feet: L: 20 ft x W: 18 ft = 360 sq ft
Desired acoustical improvement: Better = 29
Number of luminaires needed in the room: 360 ÷ 29 = **13 luminaires**

NOTES:

- You can mix lit and blank fixtures.
- Lumenwerx acoustic calculators were developed to act as a guide. For precise acoustic performance in a space, please consult an acoustician.

VIA 1.5 & 2

ACOUSTIX - BLANK

LUMENWERX

Project: _____

Type: _____

Technical Specifications

LUMINAIRE LENGTH

Via 1.5 and Via 2 Acoustix Blank is made up of standard 4, 6, and 8 foot sections. Consult factory for other lengths.

WEIGHT

Via 1.5 & 2 Acoustix Blank 4ft - 4.2lbs - 1.90kg

Via 1.5 & 2 Acoustix Blank 8ft - 8.4lbs - 3.8kg

MOUNTING OPTIONS

For cable-mounted fixtures - 53WAC36 (5" + 3" non-powered white canopies and 36" aircraft cables)

For stem mounted fixtures - 55WSW18 (5" + 5" non-powered white canopies and 18" white stems)

Caddy clips, if required specify under OPTIONS

CONSTRUCTION

Housing - Extruded aluminum (0.095" nominal) up to 90% recycled content

Interior brackets - Die formed cold rolled sheet steel 18 gauge thick

End caps - Die cast aluminum (0.95" nominal)

Hanger - Chromed Griplock securely attached with spring steel hardware in end caps and/or joiners

Aircraft cable suspension - 7x7 braids aluminum aircraft cable 0.06" thick

Stem - 0.5" diameter threaded steel tube matte white or aluminum powder coating. Custom finishes are also available.

FINISH

Interior - 95%, reflective matte powder coated white paint

Exterior - matte white powder coating

ACOUSTIC FINISH

Material is 100% polyester containing up to 50% of recycled plastic bottles (PET) with an ASTM E-84 Class A / CAN ULC S102 fire rating and is moisture resistant.

CARE:

Remove dust and debris with a clean, dry, soft, lint-free cloth, or vacuum.

WARRANTY:

Lumenwerx provides a five-year limited warranty of electrical and mechanical performance of the luminaires, including the LED boards, drivers, and auxiliary electronics. Lumenwerx will repair or replace defective luminaires or components at our discretion, provided they have been installed and operated in accordance with our specifications. Other limitations apply, please refer to the full warranty on our website.



WELL for Sound - This luminaire is recommended for use as an acoustical absorption surface to limit reverberation times (RT) in a given space. This luminaire contributes to noise reduction and vibration dampening to promote focus and concentration. Reverberation needs to be calculated in each space based on the materials used.