

VIA 1.5 RECESSED VERTICAL



DIRECT
STATIC WHITE

IC RATED **Declare.**



SENSORS
For latest information on sensors, click [here](#).

DIRECT



HLO

Our elegant, flexible Via family is composed of linear, pendant, surface, recessed, and wall mounted luminaires. Each lighting fixture can be installed as a discrete luminaire or in continuous runs or patterns. Via 1.5 Recessed Vertical is offered with Lambertian optic.

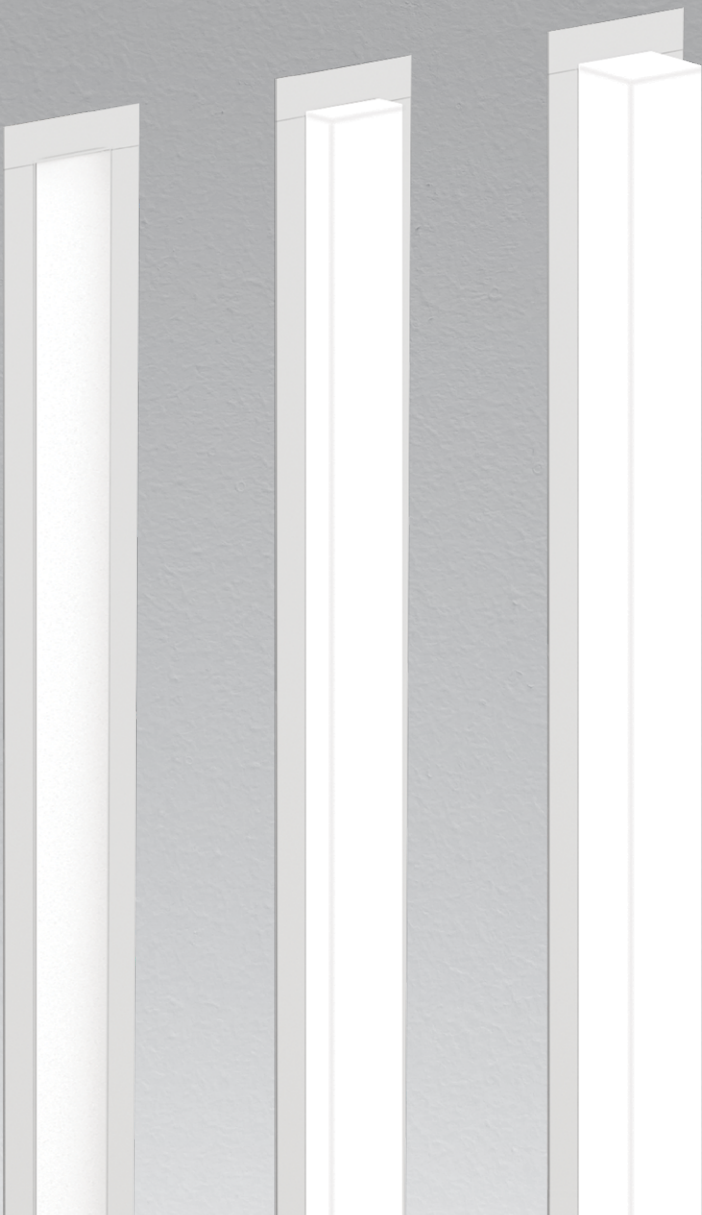

VIA 1.5 RECESSED VERTICAL



DIRECT
STATIC WHITE

Project: _____

 Type: _____

Order Guide

| LUMINAIRE ID | DISTRIBUTION | OPTIC | LENS POSITION | LIGHT SOURCE ¹ |
|---------------------------------------|--------------|--|--|---|
| VIA1.5RV | D | HLO | | SW |
| VIA1.5RV - Via 1.5" Recessed Vertical | D - Direct | HLO - High-Efficiency Lambertian Optic | FH - Flush 0.5D - 0.5" drop 1.5D - 1.5" drop | SW - Static white ¹ Chromawerx SOLA, DUO, and QUADRO also available. Consult other spec sheets. |

| CRI | LUMEN PACKAGE | COLOR TEMP. | LUMINAIRE LENGTH | VOLTAGE |
|------------------------------------|--|---|---|--|
| 80CRI - 80+ CRI 90CRI - 90+ CRI | 200LMF ² - Hypo output 200 lm/ft 350LMF - Low output 350 lm/ft 500LMF - Medium output 500 lm/ft 750LMF - High output 750 lm/ft ² Minimum 4' fixture. | 27K - 2700K 30K - 3000K 35K - 3500K 40K - 4000K 50K - 5000K | #FT#IN - Specify nominal length (#) in 1' and/or 1" increments Standard nominal lengths: Single units: 2' to 12' Continuous runs: lengths over 12' | 120V - 120V 277V - 277V UNV - 120V-277V 347V ³ - 347V ³ Available with D1 driver only. |

| DRIVER ⁴ | ELECTRICAL | ELECTRICAL SECTIONS (optional) ^{10,11} | POWER FEED |
|---|---|--|--|
| D1 - 1% 0-10V DA ⁵ - DALI LDE1 ⁵ - Lutron Hi-lume 1% Eco ELD1 - eldoLED 1% ECOdrive 0-10V ELDO - eldoLED 0.1% SOLOdrive 0-10V ELV ⁶ - ELV 120V TRI ⁶ - TRIAC 120V ⁴ PoE (Power-over-Ethernet) compatible. Consult factory for details. ⁵ On-site commissioning is required. ⁶ Available with 120V only. | 1C - 1 circuit #MC ⁷ - Multi circuit EC - Emergency-powered fixture NL - Night light fixture DL - Daylight fixture GTD ^{8,9} - Generator transfer device fixture ⁷ Specify total number of circuits (#), including any required for electrical section options. Provide drawing or layout specifications. Minimum 4' section per circuit. ⁸ Minimum 4' fixture. ⁹ Not available with 347V. | #EC## ¹² - Emergency-powered section #NL## ¹² - Night light section #DL## ¹² - Daylight section #GTD## ^{12,13,14} - Generator transfer device section #EMB ^{14,15} - Emergency battery NA - None ¹⁰ Specify with multi circuit (#MC) electrical option only. ¹¹ Provide drawing or layout specifications. Consult factory for other configurations. Default section length is 4'. ¹² Specify quantity (#), and section length in inches (##). ¹³ Minimum 4' section. ¹⁴ Not available with 347V. ¹⁵ Specify quantity (#). All batteries will be on the same circuit. Each battery powers a 4' section. | EF ¹⁶ - End feed BF - Back feed ¹⁶ Not available with multi-circuit (#MC) electrical option. |

| MOUNTING ¹⁷ | FINISH | CONTROL ^{19,20} | OPTIONS ²⁶ |
|--|---|---|---|
| DTR - Trim DTL - Trimless DMF - Drywall mud flange MFM ¹⁸ - Multiple flange mounting ¹⁷ Transition mounting options also available (e.g. Recessed to Pendant/Surface), consult factory for details. ¹⁸ See page 4 for details. | W - Matte white B - Matte black CF# - Custom finish, specify RAL# | STANDALONE CONTROLS ^{21,22} Specify the quantity (#) of sensors per fixture. #OMS ²³ - Onboard Occupancy #OMS## ²⁴ - Onboard Occupancy with bi-level dimming #ODS - Onboard Daylight #OCS - Onboard Occupancy & Daylight CONNECTED CONTROLS ²⁵ LU - Lutron AWN - Lutron Athena Wireless Node RF Only AWNS - Lutron Athena Wireless Node Sensor ENC - Encelium WL - Cooper Wavelinx AN - Acuity nLight CA - Casambi LG - Legrand NA - None ¹⁹ Standalone and connected control options cannot be combined. ²⁰ Available with flush lens option only. ²¹ Available with D1 driver and 1 circuit options only. ²² Minimum 4' per zone. Provide control zone length. ²³ Fixture turns off when no occupancy. ²⁴ Fixture dims to specified light level % (##). ²⁵ Consult factory for connected controls. | FUI20 - Fuse 120V FU277 - Fuse 277V FWC - Flexible whip cable (6' std) NA - None ²⁶ Separate codes with a "+" if more than one is specified. |

VIA 1.5 RECESSED VERTICAL

DIRECT
STATIC WHITE

Dimensions

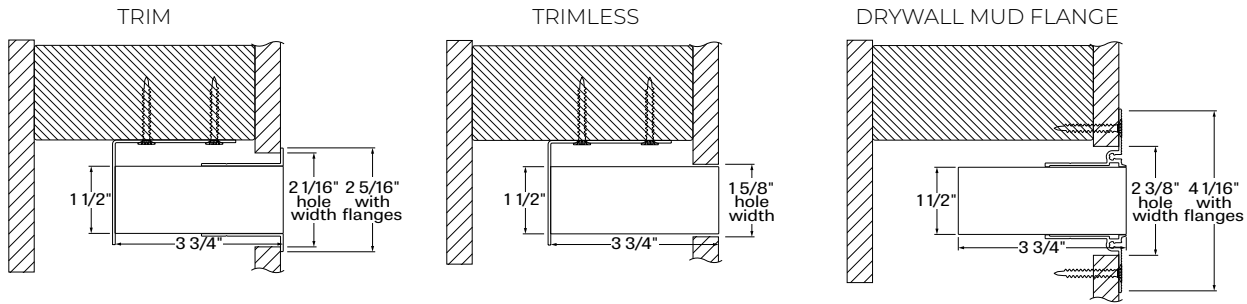

LENS POSITIONS

0.5" Drop Lens

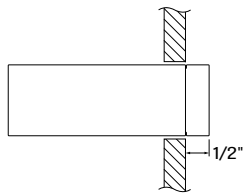

1.5" Drop Lens

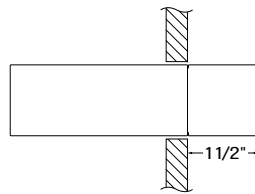

VIA 1.5 RECESSED VERTICAL

DIRECT
STATIC WHITE

Multiple Flange Mounting Details

Multiple flange mounting can be specified when a fixture run needs to have a multiple flange recessed mounting detail. A drawing is required to clearly illustrate the application.

WALL CONDITION EXAMPLES (consult factory for project specific wall conditions)

DRYWALL/WOOD

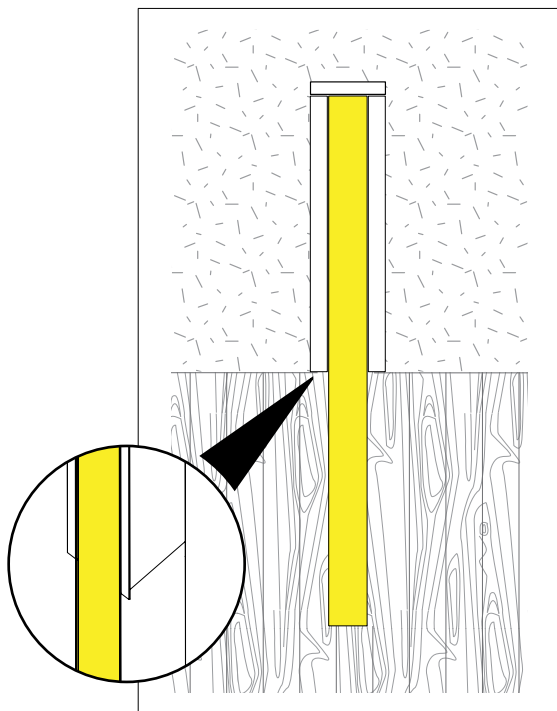

e.g. DTR/DTL
Trim to Trimless

DRYWALL/WOOD

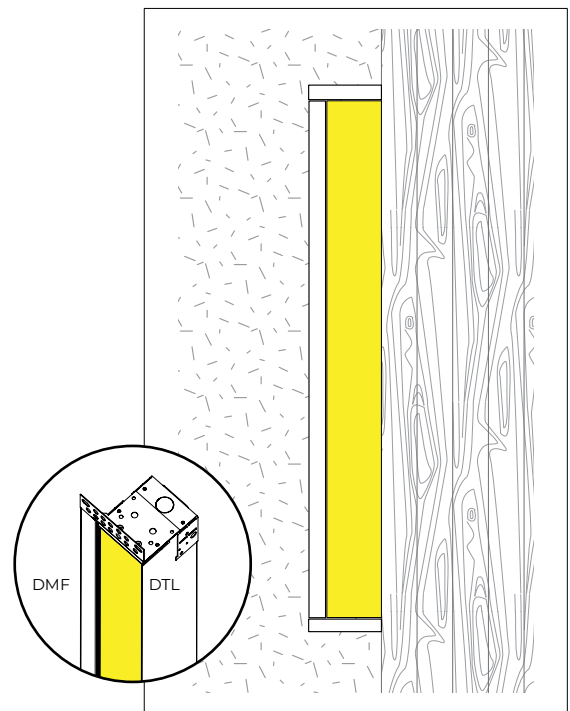

e.g. 3DMF/1DTL
3 sides DMF and 1 long side DTL

All drawings are for illustrative purposes only.

TRANSITION MOUNTING OPTIONS (consult factory for details)

Mounting condition alters along the run of the fixture.

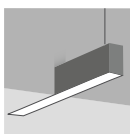

Recessed to Pendant

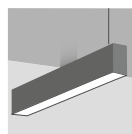

Surface to Pendant

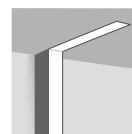

Surface to Recessed in corner

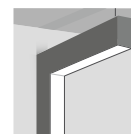

Surface to Pendant in corner

VIA 1.5 RECESSED VERTICAL

DIRECT
STATIC WHITE

Photometrics

Values calculated based on a 4' fixture at 3500K.

HLO (Flush lens)

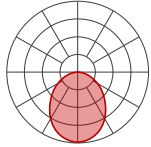

| | LM/FT | W/FT | LM/W |
|-----|-------|------|------|
| 200 | 2.7 | 75 | |
| 350 | 4.8 | 74 | |
| 500 | 7.0 | 72 | |
| 750 | 10.9 | 69 | |

MULTIPLIER TABLES

Use these tables to get results for different color temperatures and drop lenses.

Multiplier - CCT/CRI

| CCT | WATTS | |
|-------|-------------------|--------------------------|
| | 80+ CRI / 90+ CRI | LPW 80+ CRI / 90+ CRI |
| 2700K | 1.05 | 0.95 |
| 3000K | 1.02 | 0.98 |
| 3500K | 1.00 | 1.00 |
| 4000K | 1.00 | 1.00 |
| 5000K | 0.96 | 1.04 |

Multiplier - Drop lens

| DIRECT LENS | WATTS | LPW |
|----------------|-------|------|
| Flush lens | 1.00 | 1.00 |
| Drop lens 0.5" | 0.89 | 1.12 |
| Drop lens 1.5" | 0.88 | 1.14 |

VIA 1.5 RECESSED VERTICAL

DIRECT
STATIC WHITE

Technical Specifications

OPTIC

High-Efficiency Lambertian Optic (HLO)

The High-Efficiency Lambertian Optic (HLO) uses matte white reflectors to distribute LED output across 0.075" acrylic shielding, providing up to 88% transmission and good obscuration.

Available as a flush lens or as a drop lens, the HLO has a spacing criterion of 1.12.

LIGHT SOURCE

Custom linear array of mid-flux LEDs are cartridge-mounted with quick-connect wiring to facilitate service and thermal management. Available in 2700K, 3000K, 3500K, 4000K, and 5000K with a minimum 80+ CRI and an option for 90+ CRI with elevated R9 value. Color consistency maintained to within 3 SDCM. All LEDs have been tested in accordance with IESNA LM-80-08 and the results have shown L80 lumen maintenance greater than 60,000 hours. Absolute product photometry is measured and presented in accordance with IESNA LM-79, unless otherwise indicated.

LUMINAIRE LENGTH

Via 1.5 is available in standard lengths of 2' to 12'. Continuous runs are available for run lengths over 12'. Exact run length must be noted in the product code. The minimum length is 2', and can be ordered in 1' and/or 1" increments. All individual sections are joined together onsite using the joiner kits provided. Lumenwerx offers joiner kits that are extremely simple to work with in the field and result in a fixture that appears virtually seamless with no light leak at any connection.

ELECTRICAL

Factory-set, adjustable output current LED driver with universal (120-277 VAC) input. Dimmable from 100% to 1% with 0-10V dimming control. Rated life (90% survivorship) of 50,000 hours at 50°C max. ambient (and 70°C max. case) temperature. At maximum driver load: Efficiency > 84%, PF > 0.9, THD < 20%. Other specifiable options include Lutron Hi-Lume 1% Eco, eldoLED 1% ECOdrive 0-10V, eldoLED 0.1% SOLOdrive 0-10V, ELV, TRIAC, and DALI protocol drivers. All of our standard 0-10V drivers are NEMA 410 compliant. ELV and TRIAC dimming performance (including minimum dimming percentage) subject to dimmer selection.

PoE

Depending on the PoE manufacturer selected, Lumenwerx will install the node in factory as either integral to the luminaire or as a remote module. Factory programming of the PoE node may or may not enable the following functionalities: lumen package, DUO (tunable white), QUADRO (RGBW), emergency battery backup, and sensor integration. These must be addressed and evaluated on a case-by-case basis.

ELECTRICAL SECTION OPTIONS

Electrical section options are available for fixtures specified as multi circuit (#MC). With MC, specify the total number of circuits (#), including any circuits required for optional electrical sections. A drawing is required to specify the layout. Please consult factory for custom configurations.

Electrical sections

Options include emergency-powered (#EC##), night light (#NL##), daylight (#DL##), and generator transfer device (#GTD##) sections. Specify the quantity (#), as well as the section length in inches (##).

Example 1: A 32' Direct fixture with two 8' emergency-powered sections on a second circuit.

Code: 2MC-2EC96

Example 2: A 24' Direct fixture with one 4' generator transfer device section.

Code: 1MC-1GTD48

Battery

Each emergency battery (#EMB) powers a 4' section. All batteries will be on the same circuit. Specify the number of batteries (#) required.

Factory installed long life, high temperature, maintenance-free Lithium-Ion battery pack with self-test functionality, test switch and charge indicator. Minimum of 90 minutes operation, up to 1000 lumens per 4' (25°C) emergency lighting output and recharge time of 24 hours.

MOUNTING

Recessed wall mounting is available with trim, trimless, or mud flange options.

FINISH

Interior: 95%, reflective matte powder coated white paint

Exterior: Matte white or matte black powder coating. Custom finishes are also available.

VIA 1.5 RECESSED VERTICAL

DIRECT
STATIC WHITE

CONTROLS

Lumenwerx offers several options for integrating occupancy and daylight harvesting controls in our luminaires.

For latest information on sensors, click [here](#).



Standalone controls

An integrated standalone sensor controls the luminaire in which it is installed. Depending on the length, more than one sensor may be necessary and may control the entire luminaire, or just a section of it. These controls operate independently. Unless otherwise agreed, sensor location, blank size, and functionality of the sensor within the luminaire are selected by Lumenwerx. See client drawings for details.

Three types are available:

OMS: An integral Passive InfraRed (PIR) sensor turns luminaires on and off automatically with field-adjustable time out period. No wall control is used. Coverage pattern for large motion has a 12' diameter with the sensor mounted 8' above the floor; for small motion, the pattern has an 8' diameter. Typically, one sensor is required for every 10' of a continuous luminaire run.

ODS: An integral, daylight harvesting sensor with closed-loop operation dims the luminaire in which it is installed in order to compensate for available daylight. The sensor measures the combination of daylight and luminaire light reflected from horizontal surfaces below the luminaire. Initial onsite calibration is required via the use of provided remote control.

OCS: Both an occupancy and a daylight sensor are installed in the luminaire.

Connected controls

With connected controls, sensors or nodes installed in the luminaire form part of a larger control system infrastructure from manufacturers such as: Lutron, Encelium, Cooper Wavelinx, Acuity nLight, Casambi, Legrand, and others. These connected controls allow for a scalable system providing features like occupancy and daylight control, manual control, scheduling and configuration of various zones and scenes. Energy reporting and system monitoring are also possible. Specific capabilities depend on the control system being used.

Lumenwerx installs the components (sensors, nodes, power packs, etc) which may be supplied to us by a third party, or procured directly by Lumenwerx, depending on the control system manufacturer.

Lumenwerx is solely responsible for the installation of specified components; the controls manufacturer is responsible for performance of the control system.

To indicate a Lumenwerx luminaire with connected controls, identify the specific onsite control system to be integrated into the luminaires using the ordering code. Due to the diversity of components, you must contact factory to assure complete compatibility with intended control system and to fully specify the luminaire.

Complete control specifications, sensor/node/power pack layout, and narrative for the control system are required for Lumenwerx to create shop drawings and submittals.

CONSTRUCTION

Housing: Extruded aluminum, up to 90% recycled content

Interior brackets: Die-formed cold rolled sheet steel

Joining system: Die-cast zinc

Reflectors: Die-formed cold rolled steel, 95% reflective matte white painted

Lens: Acrylic

Drop lens: Extruded with glued end caps

Recessed flanges: Extruded aluminum, up to 90% recycled content

Mud flange: Extruded aluminum, up to 90% recycled content

Slip-through bracket: Die-formed galvanized sheet

End plate: Die-formed cold rolled sheet steel

WEIGHT

4': 7.16 lbs - 3.25 kg

8': 14.32 lbs - 6.5 kg

12': 21.48 lbs - 9.75 kg

CERTIFICATIONS

ETL: Rated for indoor dry/damp locations. Conforms to UL Standard 1598 and certified to CAN/CSA Standard C22.2 No. 250.0.

IC rated: Suitable for direct contact with insulation

Declare: [LBC Red List Approved](#)

WARRANTY

Lumenwerx provides a five-year limited warranty on electrical and mechanical performance of the luminaires, including the LED boards, drivers, and auxiliary electronics. Lumenwerx will repair or replace defective luminaires or components at our discretion, provided they have been installed and operated in accordance with our specifications. Other limitations apply, please refer to the full warranty on our website.