

# VIA 1.5 SURFACE PATTERN

DIRECT  
STATIC WHITE, BIOS



Declare.



Inner corner

Module Option

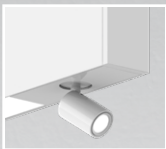

**SENSORS**  
For latest information on sensors, click [here](#).

Our elegant, flexible Via family is composed of linear, pendant, surface, recessed, and wall mounted luminaires. Each lighting fixture can be installed as a discrete luminaire or in continuous runs or patterns in which a combination of luminaires forms part of a custom design that can also incorporate less conventional acute and obtuse angles. Via 1.5 Surface is offered with Lambertian optic.

DIRECT



HLO

# VIA 1.5 SURFACE PATTERN



DIRECT  
STATIC WHITE, BIOS

Project: \_\_\_\_\_  
 \_\_\_\_\_  
 Type: \_\_\_\_\_

## Order Guide

A drawing of your pattern is required - anything from a line drawing to an architectural drawing.

LUMINAIRE ID	DISTRIBUTION	OPTIC	LENS POSITION	LIGHT SOURCE <sup>1</sup>	CRI
<b>VIA1.5SPAT</b>	<b>D</b>	<b>HLO</b>			
<b>VIA1.5SPAT</b> - Via 1.5" Surface Pattern	<b>D</b> - Direct	<b>HLO</b> - High-Efficiency Lambertian Optic	<b>FH</b> - Flush <b>0.5D</b> - 0.5" drop <b>1.5D</b> - 1.5" drop	<b>SW</b> - Static white  <b>BIOSST</b> <sup>2,3</sup> - BIOS Biological Static <b>BIOSDY</b> <sup>2,3</sup> - BIOS Biological Dynamic <b>BIOSTU</b> <sup>2,3</sup> - BIOS Biological Tunable	<b>80CRI</b> - 80+ CRI <b>90CRI</b> <sup>4</sup> - 90+ CRI  <sup>4</sup> Not available with BIOS.
				<sup>1</sup> Chromawerx SOLA, DUO, and QUADRO also available. Consult other spec sheets. <sup>2</sup> Only available with low and medium lumen packages. <sup>3</sup> See page 6 for details.	

LUMEN PACKAGE	COLOR TEMP.	PATTERN LENGTH	CORNER TYPE <sup>10</sup>
<b>200LMF</b> <sup>5</sup> - Hypo output 200 lm/ft <b>350LMF</b> - Low output 350 lm/ft <b>500LMF</b> - Medium output 500 lm/ft <b>750LMF</b> - High output 750 lm/ft <b>900LMF</b> <sup>6</sup> - Hyper output 900 lm/ft  <sup>5</sup> Minimum 4' fixture. <sup>6</sup> Fixture will be very bright. Use in suitable applications.	<b>27K</b> <sup>7</sup> - 2700K <b>30K</b> - 3000K <b>35K</b> - 3500K <b>40K</b> - 4000K <b>50K</b> <sup>7</sup> - 5000K  <sup>7</sup> Not available with BIOS.	<b>##FT##IN(##X##FT##IN-##X##FT##IN-...)</b> <sup>8,9</sup> -  ##FT##IN: total nominal length of pattern in feet and/or inches ##X: quantity of each section ##FT##IN: nominal length of each section in feet and/or inches  Continuous runs: lengths over 12'  <sup>8</sup> Minimum 2'. <sup>9</sup> Available in 2' increments only with BIOSTU/BIOSDY.	<b>#LEV2C(A##)</b> - 2-way leveled corner <b>#LEV3C(A##)</b> <sup>11</sup> - 3-way leveled corner <b>#LEV4C(A##)</b> <sup>11</sup> - 4-way leveled corner <b>#INN2C(A90)</b> <sup>12</sup> - 2-way inner corner  <b>ANGLE (A##):</b> <b>(A60)</b> - 60° <b>(A90)</b> - 90° <b>(A120)</b> - 120° <b>(A##)</b> <sup>13</sup> - Custom  <sup>10</sup> Specify quantity (#) and angle (A##) for each required corner type. If more than one option is specified, separate codes with a "+", e.g. 1LEV2C(A90)+2LEV2C(A60). <sup>11</sup> Separate angles with a "+" if more than one type is required, e.g. 1LEV4C(A60+A120). <sup>12</sup> Available with 90° only. Consult factory for other angles. <sup>13</sup> Minimum angle is 30°.

VOLTAGE	DRIVER <sup>15</sup>	ELECTRICAL	ELECTRICAL SECTIONS (optional) <sup>21,22</sup>	MOUNTING CEILING	MOUNTING WALL <sup>27</sup>
<b>120V</b> - 120V <b>277V</b> - 277V <b>UNV</b> - 120V-277V <b>347V</b> <sup>14</sup> - 347V  <sup>14</sup> Available with D1 driver only.	<b>D1</b> - 1% 0-10V <b>DA</b> <sup>16</sup> - DALI <b>LDEI</b> <sup>16</sup> - Lutron Hi-lume 1% Eco <b>ELDI</b> - eldoLED 1% <b>ECODrive</b> 0-10V <b>ELDO</b> - eldoLED 0.1% <b>SOLOdrive</b> 0-10V <b>ELV</b> <sup>17</sup> - ELV 120V <b>TRI</b> <sup>17</sup> - TRIAC 120V  <sup>15</sup> PoE (Power-over-Ethernet) compatible. Consult factory for details. <sup>16</sup> On-site commissioning is required. <sup>17</sup> Available with 120V only.	<b>1C</b> - 1 circuit <b>#MC</b> <sup>18</sup> - Multi circuit <b>EC</b> - Emergency-powered fixture <b>NL</b> - Night light fixture <b>DL</b> - Daylight fixture <b>GTD</b> <sup>19,20</sup> - Generator transfer device fixture  <sup>18</sup> Specify total number of circuits (#), including any required for electrical section or module options. Provide drawing or layout specifications. Minimum 4' section per circuit. <sup>19</sup> Minimum 4' fixture. <sup>20</sup> Not available with 347V.	<b>#EC##</b> <sup>23</sup> - Emergency-powered section <b>#NL##</b> <sup>23</sup> - Night light section <b>#DL##</b> <sup>23</sup> - Daylight section <b>#GTD##</b> <sup>23,24,25</sup> - Generator transfer device section <b>#EMB</b> <sup>25,26</sup> - Emergency battery <b>NA</b> - None  <sup>21</sup> Specify with multi circuit (#MC) electrical option only. <sup>22</sup> Provide drawing or layout specifications. Consult factory for other configurations. Default section length is 4'. <sup>23</sup> Specify quantity (#), and section length in inches (##). <sup>24</sup> Minimum 4' section. <sup>25</sup> Not available with 347V. <sup>26</sup> Specify quantity (#). All batteries will be on the same circuit. Each battery powers a 4' section.	<b>DRC</b> - Drywall ceiling <b>GRD</b> - Grid ceiling	<b>DRM</b> - Drywall mounting <b>DMB</b> - Drywall mounting bracket <b>NA</b> - Not applicable  <sup>27</sup> Not available with leveled corners.

FINISH	CONTROL <sup>28,29</sup>	OPTION	MODULE (optional) <sup>35,36</sup>
<b>W</b> - Matte white <b>AL</b> - Aluminum <b>B</b> - Matte black <b>CF#</b> - Custom finish, specify RAL#	<b>STANDALONE CONTROLS</b> <sup>30,31</sup> Specify the quantity (#) of sensors per fixture. <b>#OMS</b> <sup>32</sup> - Onboard Occupancy <b>#OMS##</b> <sup>33</sup> - Onboard Occupancy with bi-level dimming <b>#ODS</b> - Onboard Daylight <b>#OCS</b> - Onboard Occupancy & Daylight  <b>NA</b> - None  <sup>28</sup> Standalone and connected control options cannot be combined. <sup>29</sup> Available with flush lens option only. <sup>30</sup> Available with D1 driver and 1 circuit options only. <sup>31</sup> Minimum 4' per zone. Provide control zone length.	<b>CONNECTED CONTROLS</b> <sup>34</sup> <b>LU</b> - Lutron <b>AWNR</b> - Lutron Athena Wireless Node RF Only <b>AWNS</b> - Lutron Athena Wireless Node Sensor <b>ENC</b> - Encelium  <b>WL</b> - Cooper Wavelinx <b>AN</b> - Acuity nLight <b>CA</b> - Casambi <b>LG</b> - Legrand  <sup>32</sup> Fixture turns off when no occupancy. <sup>33</sup> Fixture dims to specified light level % (##). <sup>34</sup> Consult factory for connected controls.	<b>FUI20</b> - Fuse 120V <b>FU277</b> - Fuse 277V <b>NA</b> - None  <b>#MS25()</b> - Micro Spot 25° <b>#MS35()</b> - Micro Spot 35° <b>#MS50()</b> - Micro Spot 50° <b>NA</b> - None  <sup>35</sup> See page 3 for ordering details. <sup>36</sup> Not available with ELV/TRI driver options.



# VIA 1.5 SURFACE PATTERN



DIRECT  
STATIC WHITE, BIOS

## Module Code

For a module, specify the options in the parentheses.  
The light source is static white.  
CRI of module matches specification of main fixture.

Example: 1MS25(5W-27K-W)

MODULE (optional)			
MODULE <sup>1,2</sup>	WATTAGE	COLOR TEMPERATURE	FINISH
<b>#MS25( )</b> - Micro Spot 25° <b>#MS35( )</b> - Micro Spot 35° <b>#MS50( )</b> - Micro Spot 50°  <sup>1</sup> Specify quantity (#). <sup>2</sup> 6" Blank per module. Blank finish will match fixture finish.	<b>5W</b> - 5 W, up to 430 lm output	<b>27K</b> - 2700K <b>30K</b> - 3000K <b>35K</b> - 3500K <b>40K</b> - 4000K <b>50K</b> - 5000K	<b>W</b> - Matte white <b>B</b> - Matte black

## Dimensions

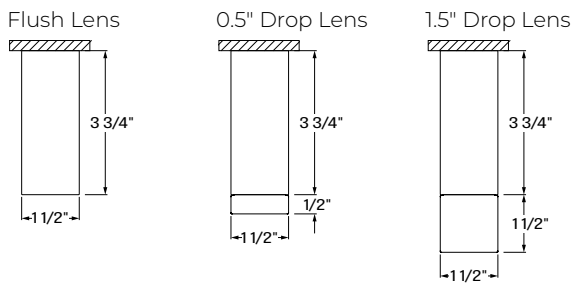

# VIA 1.5 SURFACE PATTERN

DIRECT  
STATIC WHITE, BIOS

## Pattern Layout

### CORNER TYPES

#### LEVELED CORNERS

#### INNER CORNER

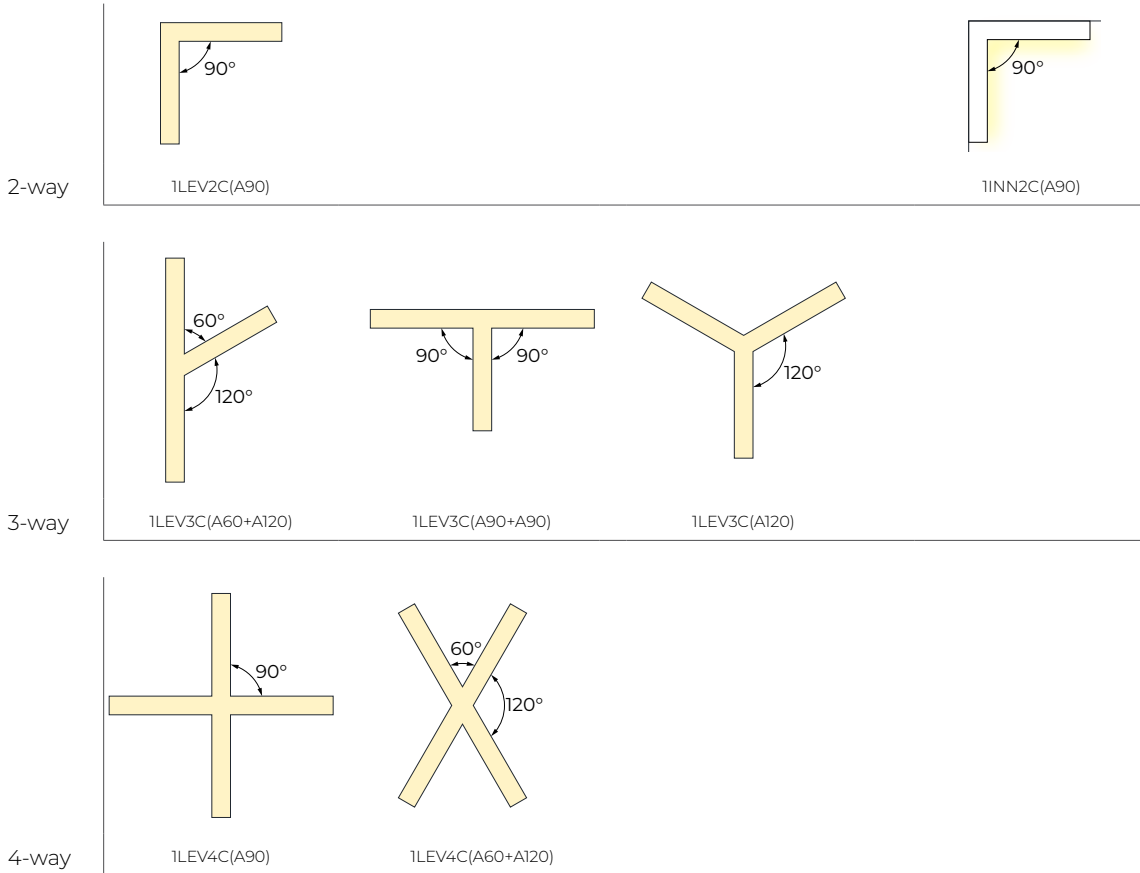

### EXAMPLES

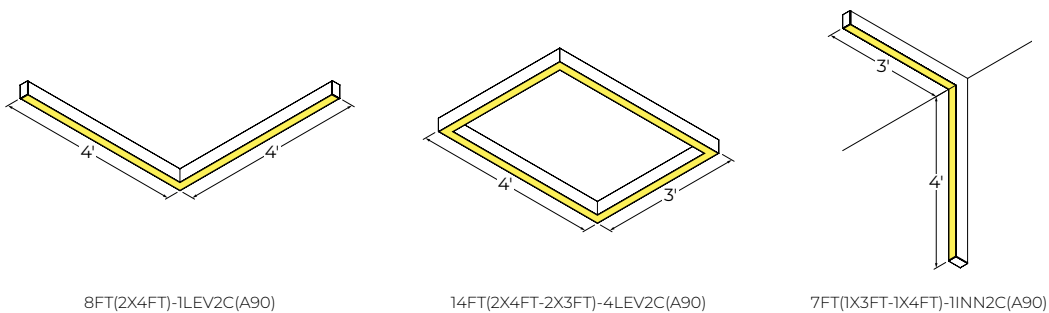

# VIA 1.5 SURFACE PATTERN



DIRECT  
STATIC WHITE, BIOS

## Photometrics

Values calculated based on a 4' fixture at 3500K.

HLO (Flush lens)

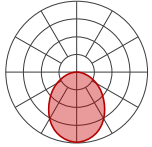

	LM/FT	W/FT	LM/W
200	2.7	75	
350	4.8	74	
500	7.0	72	
750	10.9	69	
900	13.4	67	

### MULTIPLIER TABLES

Use these tables to get results for different color temperatures and drop lenses.

Multiplier - CCT/CRI

CCT	WATTS	LPW
	80+ CRI / 90+ CRI	80+ CRI / 90+ CRI
2700K	1.05	0.95
3000K	1.02	0.98
3500K	1.00	1.00
4000K	1.00	1.00
5000K	0.96	1.04

Multiplier - Drop lens

DIRECT LENS	WATTS	LPW
Flush lens	1.00	1.00
Drop lens 0.5"	0.89	1.12
Drop lens 1.5"	0.88	1.14

### MICRO SPOT MODULE

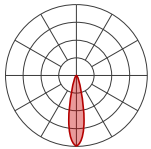

Micro Spot 25°

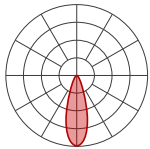

Micro Spot 35°

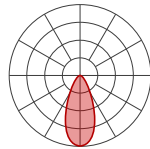

Micro Spot 50°

### DELIVERED LUMENS

Wattage	5.0									
	80+					90+				
CRI	2700K	3000K	3500K	4000K	5000K	2700K	3000K	3500K	4000K	5000K
Lumen	373	400	400	432	432	324	344	344	345	372

# VIA 1.5 SURFACE PATTERN



DIRECT  
STATIC WHITE, BIOS

## BIOS

Three BIOS Circadian LED solutions are offered – Biological Static, Biological Dynamic, and Biological Tunable. Use the decision tree below to identify when and where to use BIOS Wellness LED Lighting Solutions.

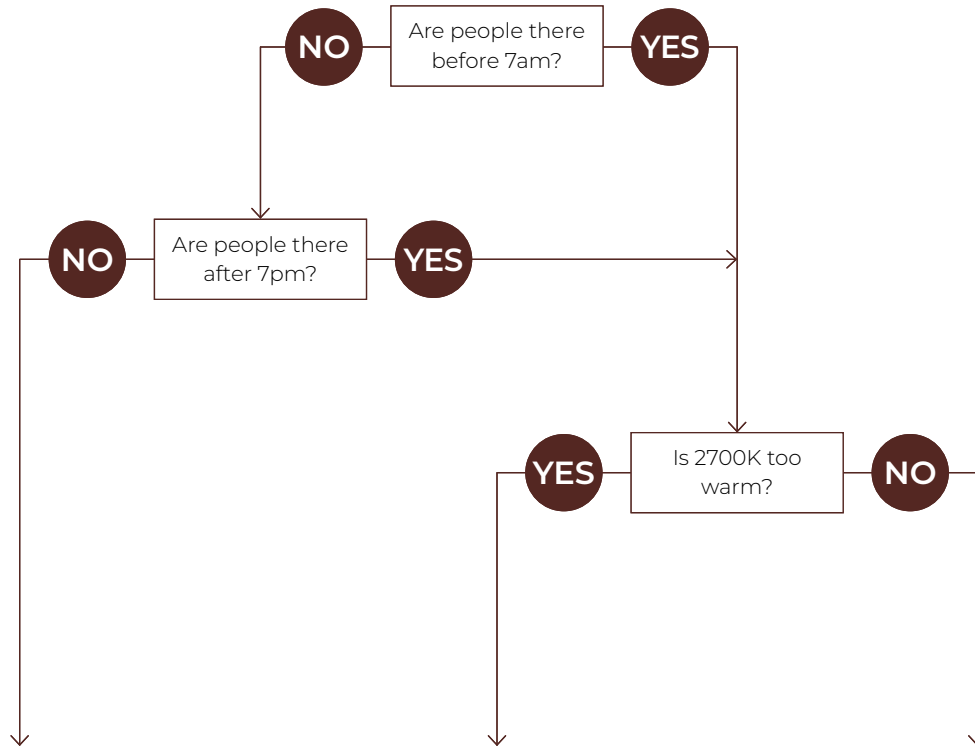

Biological Static BIOSST	Biological Dynamic BIOSDY	Biological Tunable BIOSTU
No CCT change when dimmed	500K shift when dimmed	Dims to 2700K
Daytime solution	Daytime + evening solution	Daytime + evening solution
Spaces in operation during daytime hours, between 7am and 7pm	Spaces in operation overnight, after 7pm and before 7am, and when CCT color shift in the evening is not preferred	Suitable for spaces in operation overnight, after 7pm and before 7am, and where people do not sleep (CCT color shift in the evening is preferred)
E.g. offices, medical/dental offices	E.g. hospitals	E.g. offices, shiftwork

# VIA 1.5 SURFACE PATTERN



DIRECT  
STATIC WHITE, BIOS

## Technical Specifications

### OPTIC

#### High-Efficiency Lambertian Optic (HLO)

The High-Efficiency Lambertian Optic (HLO) uses matte white reflectors to distribute LED output across 0.075" acrylic shielding, providing up to 88% transmission and good obscuration. Available as a flush lens or as a drop lens, the HLO has a spacing criterion of 1.12.

### LIGHT SOURCE

#### Static white

Custom linear array of mid-flux LEDs are cartridge-mounted with quick-connect wiring to facilitate service and thermal management. Available in 2700K, 3000K, 3500K, 4000K, and 5000K with a minimum 80+ CRI and an option for 90+ CRI with elevated R9 value. Color consistency maintained to within 3 SDCM. All LEDs have been tested in accordance with IESNA LM-80-08 and the results have shown L80 lumen maintenance greater than 60,000 hours. Absolute product photometry is measured and presented in accordance with IESNA LM-79, unless otherwise indicated.

### BIOS

BIOS SkyBlue™ Technology is designed to provide the specific circadian stimulus to improve overall sleep quality, recovery during the night, and overall feelings of well-being. The non-visual light signals that stimulate our circadian system have peak intensity in the "sky blue" region. As the diagram below illustrates, BIOS SkyBlue technology shifts the peak LED spectral intensity (490 nm) to align better with the peak response of circadian stimulus. Also note the enhanced deep-red (near 660 nm) spectrum.

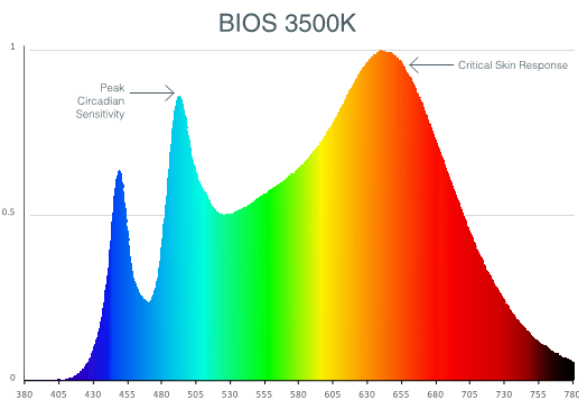

Three BIOS solutions are offered: BIOS Biological Static (BIOSST), BIOS Biological Dynamic (BIOSDY), and BIOS Biological Tunable (BIOSTU). See page 6 for details.

### PATTERN LENGTH

All individual sections are joined together onsite using the joiner kits provided. Lumenwerx offers joiner kits that are extremely simple to work with in the field and result in a fixture that appears virtually seamless with no light leak at any connection.

### ELECTRICAL

Factory-set, adjustable output current LED driver with universal (120-277 VAC) input. Dimmable from 100% to 1% with 0-10V dimming control. Rated life (90% survivorship) of 50,000 hours at 50°C max. ambient (and 70°C max. case) temperature. At maximum driver load: Efficiency>84%, PF>0.9, THD<20%. Other specifiable options include Lutron Hi-Lume 1% Eco, eldoLED 1% ECOdrive 0-10V, eldoLED 0.1% SOLOdrive 0-10V, ELV, TRIAC, and DALI protocol drivers. All of our standard 0-10V drivers are NEMA 410 compliant. ELV and TRIAC dimming performance (including minimum dimming percentage) subject to dimmer selection.

### PoE

Depending on the PoE manufacturer selected, Lumenwerx will install the node in factory as either integral to the luminaire or as a remote module. Factory programming of the PoE node may or may not enable the following functionalities: lumen package, DUO (tunable white), QUADRO (RGBW), emergency battery backup, and sensor integration. These must be addressed and evaluated on a case-by-case basis.

### ELECTRICAL SECTION OPTIONS

Electrical section options are available for fixtures specified as multi circuit (#MC). With MC, specify the total number of circuits (#), including any circuits required for optional electrical sections. A drawing is required to specify the layout. Please consult factory for custom configurations.

### Electrical sections

Options include emergency-powered (#EC##), night light (#NL##), daylight (#DL##), and generator transfer device (#GTD##) sections. Specify the quantity (#), as well as the section length in inches (##).

Example 1: A 32' Direct fixture with two 8' emergency-powered sections on a second circuit.  
Code: 2MC-2EC96

Example 2: A 24' Direct fixture with one 4' generator transfer device section.  
Code: 1MC-1GTD48

# VIA 1.5 SURFACE PATTERN



DIRECT  
STATIC WHITE, BIOS

## Battery

Each emergency battery (#EMB) powers a 4' section. All batteries will be on the same circuit. Specify the number of batteries (#) required.

Factory installed long life, high temperature, maintenance-free Lithium-Ion battery pack with self-test functionality, test switch and charge indicator. Minimum of 90 minutes operation, up to 1000 lumens per 4' (25°C) emergency lighting output and recharge time of 24 hours.

## MOUNTING

Fixtures can be mounted directly to T-bar, drywall and hard surface ceilings, hardware supplied by others. Long runs require a minimum of 6" from the vertical wall.

## FINISH

**Interior:** 95%, reflective matte powder coated white paint

**Exterior:** Matte white, matte black or aluminum powder coating. Custom finishes are also available.

## CONTROLS

Lumenwerx offers several options for integrating occupancy and daylight harvesting controls in our luminaires.

For latest information on sensors, click [here](#).



## Standalone controls

An integrated standalone sensor controls the luminaire in which it is installed. Depending on the length, more than one sensor may be necessary and may control the entire luminaire, or just a section of it. These controls operate independently. Unless otherwise agreed, sensor location, blank size, and functionality of the sensor within the luminaire are selected by Lumenwerx. See client drawings for details.

Three types are available:

**OMS:** An integral Passive InfraRed (PIR) sensor turns luminaires on and off automatically with field-adjustable time out period. No wall control is used. Coverage pattern for large motion has a 12' diameter with the sensor mounted 8' above the floor; for small motion, the pattern has an 8' diameter. Typically, one sensor is required for every 10' of a continuous luminaire run.

**ODS:** An integral, daylight harvesting sensor with closed-loop operation dims the luminaire in which it is installed in order to compensate for available daylight. The sensor measures the combination of daylight and luminaire light reflected from horizontal surfaces below the luminaire. Initial onsite calibration is required via the use of provided remote control.

**OCS:** Both an occupancy and a daylight sensor are installed in the luminaire.

## Connected controls

With connected controls, sensors or nodes installed in the luminaire form part of a larger control system infrastructure from manufacturers such as: Lutron, Encelium, Cooper Wavelinx, Acuity nLight, Casambi, Legrand, and others. These connected controls allow for a scalable system providing features like occupancy and daylight control, manual control, scheduling and configuration of various zones and scenes. Energy reporting and system monitoring are also possible. Specific capabilities depend on the control system being used.

Lumenwerx installs the components (sensors, nodes, power packs, etc) which may be supplied to us by a third party, or procured directly by Lumenwerx, depending on the control system manufacturer.

Lumenwerx is solely responsible for the installation of specified components; the controls manufacturer is responsible for performance of the control system.

To indicate a Lumenwerx luminaire with connected controls, identify the specific onsite control system to be integrated into the luminaires using the ordering code. Due to the diversity of components, you must contact factory to assure complete compatibility with intended control system and to fully specify the luminaire.

Complete control specifications, sensor/node/power pack layout, and narrative for the control system are required for Lumenwerx to create shop drawings and submittals.

## MICRO SPOT MODULE

The Micro Spot is a  $\varnothing 7/8"$  x  $1 5/16"$  adjustable spotlight that extends, retracts, rotates 360°, and tilts 90°. Its LED light source is coupled with a TIR refractor to provide beam angles of 25°, 35°, and 50°, while producing up to 400 lumens. LED light source CCT options are 2700K, 3000K, 3500K, 4000K, and 5000K available in either 80+ CRI or 90+ CRI. The Micro Spot is offered in a white or black finish. The Micro Spot driver is mounted within the luminaire housing and accepts universal input voltage (120-277 VAC) with 0-10V dimming control.

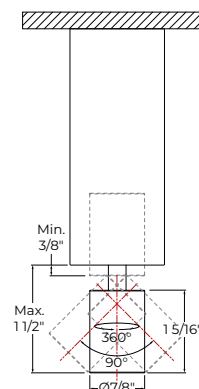

Micro Spot

Lumenwerx reserves the right to modify product specifications without notification.  
© Lumenwerx, ULC. All rights reserved.

VIA1.5-SURFACE-PAT-SPEC-REV5

September 30, 2025

# VIA 1.5 SURFACE PATTERN



DIRECT  
STATIC WHITE, BIOS

## CONSTRUCTION

**Housing:** Extruded aluminum, up to 90% recycled content

**Interior brackets:** Die-formed cold rolled sheet steel

**Joining system:** Die-cast zinc

**Reflectors:** Die-formed cold rolled steel, 95% reflective matte white painted

**Lens:** Acrylic

**Drop lens:** Extruded with glued end caps

**End caps:** Die-cast aluminum

## CERTIFICATIONS

**ETL:** Rated for indoor dry/damp locations. Conforms to UL Standard 1598 and certified to CAN/CSA Standard C22.2 No. 250.0.

**Declare:** [LBC Red List Approved](#)

## WARRANTY

Lumenwerx provides a five-year limited warranty on electrical and mechanical performance of the luminaires, including the LED boards, drivers, and auxiliary electronics. Lumenwerx will repair or replace defective luminaires or components at our discretion, provided they have been installed and operated in accordance with our specifications. Other limitations apply, please refer to the full warranty on our website.