

VIA 1.5 WALL

DIRECT/INDIRECT, DIRECT, INDIRECT
STATIC WHITE, BIOS



Declare.



SENSORS
For latest information on sensors, click [here](#).



Our elegant, flexible Via family is composed of linear, pendant, surface, recessed, and wall mounted luminaires. Each lighting fixture can be installed as a discrete luminaire or in continuous runs or patterns. Via 1.5 Wall is offered with Lambertian, asymmetric, or low-glare optics.

DIRECT



INDIRECT



VIA 1.5 WALL



DIRECT/INDIRECT, DIRECT, INDIRECT
STATIC WHITE, BIOS

Project: _____

 Type: _____

Order Guide

LUMINAIRE ID	DISTRIBUTION	DIRECT OPTIC Specify NA for indirect fixture	LENS POSITION Specify NA for indirect fixture	INDIRECT OPTIC Specify NA for Direct fixture	LIGHT SOURCE ⁵
VIA1.5W					
VIA1.5W - Via 1.5" Wall	DI - Direct/Indirect D - Direct I - Indirect	HLO - High-Efficiency Lambertian Optic LGO - Low-Glare Optic MPO - Micro-Prismatic Optic NA - Not applicable	FH ¹ - Flush 0.5D ¹ - 0.5" drop 1.5D ¹ - 1.5" drop NA ¹ - Not applicable ¹ For HLO, specify FH, 0.5D, or 1.5D. • For LGO and MPO, specify FH. • For an indirect fixture, specify NA.	CLO ² - Clear Lambertian Optic WAI2 ³ - Widespread Asymmetric Indirect Optic HLO ⁴ - High-Efficiency Lambertian Optic NA - Not applicable ² Available only with Direct/Indirect. ³ Not available with BIOS. ⁴ Not available with Direct/Indirect.	SW - Static white BIOSST ^{6,7} - BIOS Biological Static BIOSDY ^{6,7} - BIOS Biological Dynamic BIOSTU ^{6,7} - BIOS Biological Tunable ⁵ Chromawerx SOLA, DUO, and QUADRO also available. Consult other spec sheets. ⁶ Only available with low and medium lumen packages. ⁷ See page 5 for details.

CRI	DIRECT LUMEN PACKAGE Specify NA for indirect fixture	INDIRECT LUMEN PACKAGE Specify NA for Direct fixture	COLOR TEMP.	LUMINAIRE LENGTH	VOLTAGE
80CRI - 80+ CRI 90CRI ⁸ - 90+ CRI ⁸ Not available with BIOS.	200LMF ⁹ - Hypo output 200 lm/ft 350LMF - Low output 350 lm/ft 500LMF - Medium output 500 lm/ft 750LMF ¹⁰ - High output 750 lm/ft 900LMF ^{11,12,13} - Hyper output 900 lm/ft NA - Not applicable ⁹ Minimum 4' fixture. ¹⁰ For Direct/Indirect, indirect must not exceed 500 lm/ft. ¹¹ Not available with LGO.	350LMF ⁹ - Low output 350 lm/ft 500LMF - Medium output 500 lm/ft 750LMF ¹⁴ - High output 750 lm/ft 900LMF ^{12,13} - Hyper output 900 lm/ft NA - Not applicable ¹² For Direct fixture only or indirect fixture only. ¹³ Fixture will be very bright. Use in suitable applications. ¹⁴ For Direct/Indirect, Direct must not exceed 500 lm/ft.	27K ¹⁵ - 2700K 30K - 3000K 35K - 3500K 40K - 4000K 50K ¹⁵ - 5000K ¹⁵ Not available with BIOS.	#FT#IN ^{16,17} - Specify nominal length (#) in 1" and/or 1" increments Standard nominal lengths: Single units: 2' to 12' (up to 8' for MPO) Continuous runs: lengths over 12' (8' for MPO) ¹⁶ Minimum 3' for Direct/Indirect. ¹⁷ Available in 2' increments only with BIOSTU/BIOSDY.	120V - 120V 277V - 277V UNV - 120V-277V 347V ¹⁸ - 347V ¹⁸ Available with D1 driver only.

DRIVER ¹⁹	ELECTRICAL	ELECTRICAL SECTIONS (optional) ^{26,27}	MOUNTING
DI - 1% 0-10V DA ²⁰ - DALI LDE1 ²⁰ - Lutron Hi-lume 1% Eco ELD1 - eldoLED 1% ECOdrive 0-10V ELDO - eldoLED 0.1% SOLOdrive 0-10V ELV ²¹ - ELV 120V TRI ²¹ - TRIAC 120V ¹⁹ PoE (Power-over-Ethernet) compatible. Consult factory for details. ²⁰ On-site commissioning is required. ²¹ Available with 120V only.	1C - 1 circuit 2C ²² - 2 circuits #MC ²³ - Multi circuit EC - Emergency-powered fixture NL - Night light fixture DL - Daylight fixture GTD ^{24,25} - Generator transfer device fixture ²² Available for Direct/Indirect only. Separate direct and indirect circuits. ²³ Specify total number of circuits (#), including any required for electrical section options. Provide drawing or layout specifications. Minimum 4' section per circuit. ²⁴ Minimum 4' fixture. ²⁵ Not available with 347V.	#EC## ²⁸ - Emergency-powered section #NL## ²⁸ - Night light section #DL## ²⁸ - Daylight section #GTD## ^{28,29,30} - Generator transfer device section #EMB ^{30,31} - Emergency battery NA - None ²⁶ Specify with multi circuit (#MC) electrical option only. ²⁷ Provide drawing or layout specifications. Consult factory for other configurations. Default section length is 4'. ²⁸ Specify quantity (#), and section length in inches (##). ²⁹ Minimum 4' section. ³⁰ Not available with 347V. ³¹ Specify quantity (#). All batteries will be on the same circuit. Each battery powers a 4' section. For Direct/Indirect, minimum 8' fixture.	DMB - Drywall mounting bracket

FINISH	CONTROL ^{32,33,34}	OPTION
W - Matte white AL - Aluminum B - Matte black CF# - Custom finish, specify RAL#	STANDALONE CONTROLS ^{35,36} Specify the quantity (#) of sensors per fixture. #ODS - Onboard Daylight NA - None ³² Standalone and connected control options cannot be combined. ³³ Available with flush lens option only. ³⁴ Consult factory for connected controls. Compatible systems include Lutron, Enceium, Cooper, Acuity, Casambi, and Legrand. ³⁵ Available with D1 driver and 1 circuit options only. ³⁶ Minimum 4' per zone. Provide control zone length.	FU120 - Fuse 120V FU277 - Fuse 277V NA - None



VIA 1.5 WALL



DIRECT/INDIRECT, DIRECT, INDIRECT
STATIC WHITE, BIOS

Dimensions

DIRECT/INDIRECT

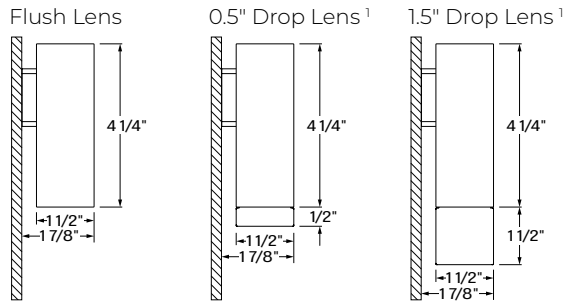

DIRECT or INDIRECT

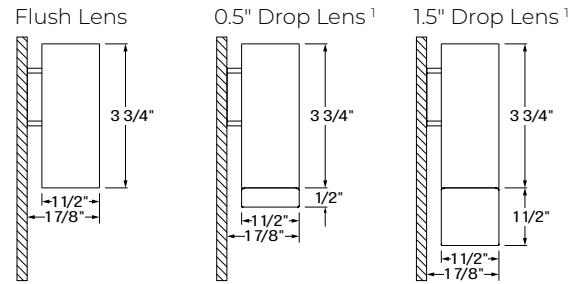

¹Drop lens positions available with HLO direct lens only.

VIA 1.5 WALL



DIRECT/INDIRECT, DIRECT, INDIRECT
 STATIC WHITE, BIOS

Photometrics

Values calculated based on a 4' fixture at 3500K for all optics.

DIRECT OPTICS

HLO (Flush lens)

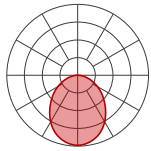

LM/FT	W/FT	LM/W
200	2.7	75
350	4.8	74
500	7.0	72
750	10.9	69
900	13.4	67

LGO

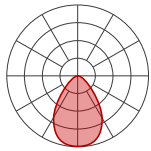

LM/FT	W/FT	LM/W
200	3.1	65
350	5.6	63
500	8.4	60
750	13.5	56

MPO

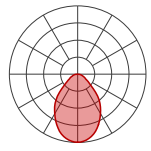

LM/FT	W/FT	LM/W
200	2.2	92
350	3.9	89
500	5.8	86
750	9.2	81
900	11.5	78

INDIRECT OPTICS

CLO

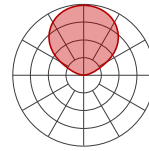

LM/FT	W/FT	LM/W
350	2.3	154
500	3.3	150
750	5.2	144
900	6.4	141

WAI2

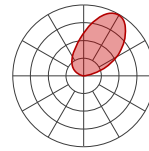

LM/FT	W/FT	LM/W
350	2.5	139
500	3.7	135
750	5.8	130
900	7.1	126

HLO

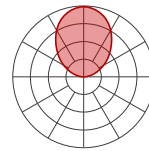

LM/FT	W/FT	LM/W
350	4.8	74
500	7.0	72
750	10.9	69
900	13.4	67

MULTIPLIER TABLES

Use these tables to get results for different color temperatures and drop lenses for all photometric tables.

Multiplier - CCT/CRI

CCT	WATTS		LPW
	80+ CRI / 90+ CRI	80+ CRI / 90+ CRI	
2700K	1.05	0.95	
3000K	1.02	0.98	
3500K	1.00	1.00	
4000K	1.00	1.00	
5000K	0.96	1.04	

Multiplier - Drop lens

DIRECT LENS	WATTS	LPW
Flush lens	1.00	1.00
Drop lens 0.5"	0.89	1.12
Drop lens 1.5"	0.88	1.14

DIRECT/INDIRECT - LPW CALCULATION

For Direct/Indirect performance values, follow the formula.

$$\left(\frac{\text{DIRECT LM/FT} + \text{INDIRECT LM/FT}}{\text{DIRECT W/FT} + \text{INDIRECT W/FT}} \right) = \text{LPW}$$

VIA 1.5 WALL



DIRECT/INDIRECT, DIRECT, INDIRECT
 STATIC WHITE, BIOS

BIOS

Three BIOS Circadian LED solutions are offered – Biological Static, Biological Dynamic, and Biological Tunable.
 Use the decision tree below to identify when and where to use BIOS Wellness LED Lighting Solutions.

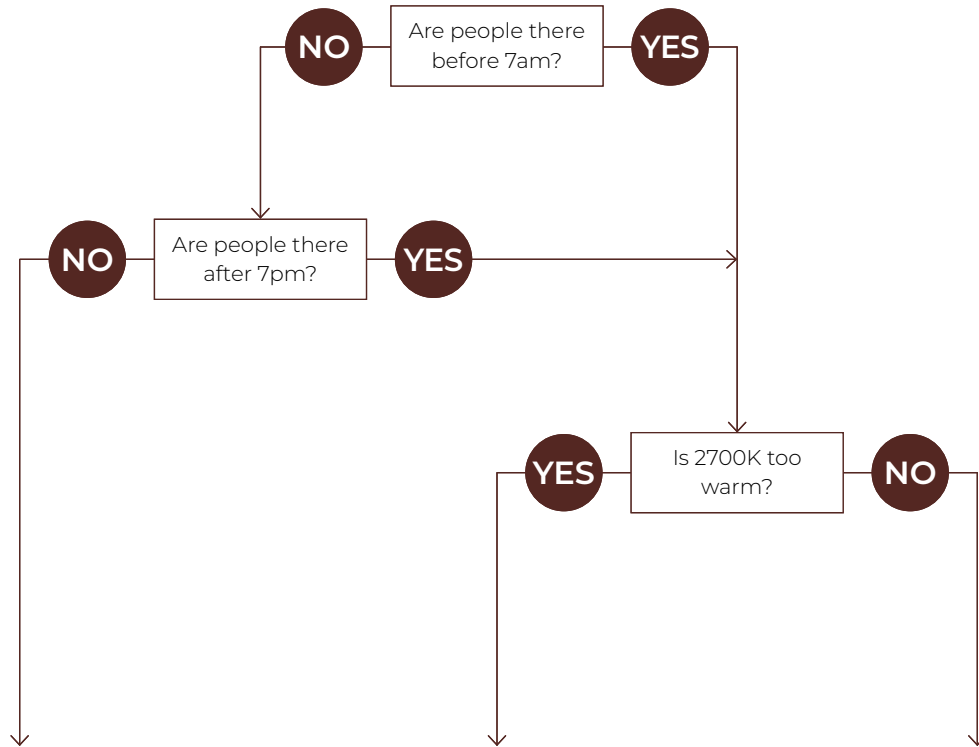

Biological Static BIOSST	Biological Dynamic BIOSDY	Biological Tunable BIOSTU
No CCT change when dimmed	500K shift when dimmed	Dims to 2700K
Daytime solution	Daytime + evening solution	Daytime + evening solution
Spaces in operation during daytime hours, between 7am and 7pm	Spaces in operation overnight, after 7pm and before 7am, and when CCT color shift in the evening is not preferred	Suitable for spaces in operation overnight, after 7pm and before 7am, and where people do not sleep (CCT color shift in the evening is preferred)
E.g. offices, medical/dental offices	E.g. hospitals	E.g. offices, shiftwork

VIA 1.5 WALL



DIRECT/INDIRECT, DIRECT, INDIRECT
STATIC WHITE, BIOS

Technical Specifications

DIRECT OPTICS

High-Efficiency Lambertian Optic (HLO)

The High-Efficiency Lambertian Optic (HLO) uses matte white reflectors to distribute LED output across 0.075" acrylic shielding, providing up to 88% transmission and good obscuration. Available as a flush lens or as a drop lens, the HLO has a spacing criterion of 1.12.

Low-Glare Optic (LGO)

The Low-Glare Optic (LGO) is designed to cut off high-angled light and control glare. The carefully crafted lens refracts light downward through its center from which it then disperses into a wide conical distribution that negates any illumination at about 40°. The LGO provides the visual comfort of a louver in a smooth acrylic lens.

Micro-Prismatic Optic (MPO)

The Micro-Prismatic Optic (MPO) delivers high-efficiency, low-glare illumination with UGR <17. Its precision-engineered lens, composed of thousands of tiny prisms, diffuses light to reduce glare, producing a ceiling plane that reads smooth from a distance while revealing subtle texture up close. The result is balanced, efficient illumination with a refined architectural presence.

INDIRECT OPTICS

Clear Lambertian Optic (CLO)

The Clear Lambertian Optic (CLO) uses a single horizontal LED array and a clear acrylic cover to provide simple uplight with high efficiency.

Widespread Asymmetric Indirect Optic (WAI2)

The Widespread Asymmetric Indirect Optic (WAI2) offers an upward grazing effect with a 45° forward throw. It softly highlights the ceiling in the up-light while distributing the required illumination of the rest of an interior space. For avoiding glare and enjoying visual comfort, WAI2 is an ideal solution.

High-Efficiency Lambertian Optic (HLO)

The High-Efficiency Lambertian Optic (HLO) uses matte white reflectors to distribute LED output across 0.075" acrylic shielding, providing up to 88% transmission and good obscuration. HLO has a spacing criterion of 1.12.

LIGHT SOURCE

Static white

Custom linear array of mid-flux LEDs are cartridge-mounted with quick-connect wiring to facilitate service and thermal management. Available in 2700K, 3000K, 3500K, 4000K, and 5000K with a minimum 80+ CRI and an option for 90+ CRI with elevated R9 value. Color consistency maintained to within 3 SDCM. All LEDs have been tested in accordance with IESNA LM-80-08 and the results have shown L80 lumen maintenance greater than 60,000 hours. Absolute product photometry is measured and presented in accordance with IESNA LM-79, unless otherwise indicated.

BIOS

BIOS SkyBlue™ Technology is designed to provide the specific circadian stimulus to improve overall sleep quality, recovery during the night, and overall feelings of well-being. The non-visual light signals that stimulate our circadian system have peak intensity in the "sky blue" region. As the diagram below illustrates, BIOS SkyBlue technology shifts the peak LED spectral intensity (490 nm) to align better with the peak response of circadian stimulus. Also note the enhanced deep-red (near 660 nm) spectrum.

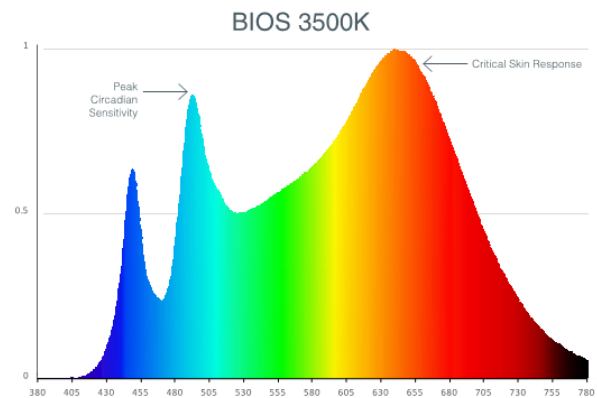

Three BIOS solutions are offered: BIOS Biological Static (BIOSST), BIOS Biological Dynamic (BIOSDY), and BIOS Biological Tunable (BIOSTU). See page 5 for details.

VIA 1.5 WALL



DIRECT/INDIRECT, DIRECT, INDIRECT
STATIC WHITE, BIOS

LUMINAIRE LENGTH

Via 1.5 is available in standard lengths of 2' to 12' (up to 8' for MPO). Continuous runs are available for run lengths over 12' (8' for MPO). Exact run length must be noted in the product code. The minimum length is 2' for Direct or Indirect fixtures, and 3' for Direct/Indirect fixtures. Lengths can be ordered in 1' and/or 1" increments, and 2' increments for BIOSTU and BIOSDY. All individual sections are joined together onsite using the joiner kits provided. Lumenwerx offers joiner kits that are extremely simple to work with in the field and result in a fixture that appears virtually seamless with no light leak at any connection.

ELECTRICAL

Factory-set, adjustable output current LED driver with universal (120-277 VAC) input. Dimmable from 100% to 1% with 0-10V dimming control. Rated life (90% survivorship) of 50,000 hours at 50°C max. ambient (and 70°C max. case) temperature. At maximum driver load: Efficiency>84%, PF>0.9, THD<20%. Other specifiable options include Lutron Hi-Lume 1% Eco, eldoLED 1% ECOdrive 0-10V, eldoLED 0.1% SOLOdrive 0-10V, ELV, TRIAC, and DALI protocol drivers. All of our standard 0-10V drivers are NEMA 410 compliant. ELV and TRIAC dimming performance (including minimum dimming percentage) subject to dimmer selection.

PoE

Depending on the PoE manufacturer selected, Lumenwerx will install the node in factory as either integral to the luminaire or as a remote module. Factory programming of the PoE node may or may not enable the following functionalities: lumen package, DUO (tunable white), QUADRO (RGBW), emergency battery backup, and sensor integration. These must be addressed and evaluated on a case-by-case basis.

ELECTRICAL SECTION OPTIONS

Electrical section options are available for fixtures specified as multi circuit (#MC). With MC, specify the total number of circuits (#), including any circuits required for optional electrical sections. A drawing is required to specify the layout. Please consult factory for custom configurations.

Electrical sections

Options include emergency-powered (#EC##), night light (#NL##), daylight (#DL##), and generator transfer device (#GTD##) sections. Specify the quantity (#), as well as the section length in inches (##).

Example 1: A 32' Direct fixture with two 8' emergency-powered sections on a second circuit.

Code: 2MC-2EC96

Example 2: A 16' Direct/Indirect fixture with separate circuits for direct and indirect, and with one 4' night light section on the direct side on a third circuit.

Code: 3MC-1NL48

Example 3: A 24' Direct fixture with one 4' generator transfer device section.

Code: 1MC-1GTD48

Battery

Each emergency battery (#EMB) powers a 4' section. All batteries will be on the same circuit. Specify the number of batteries (#) required.

Factory installed long life, high temperature, maintenance-free Lithium-Ion battery pack with self-test functionality, test switch and charge indicator. Minimum of 90 minutes operation, up to 1000 lumens per 4' (25°C) emergency lighting output and recharge time of 24 hours.

MOUNTING

Fixtures may be horizontally mounted to the wall using a bracket. For long runs, a minimum of 6" from adjacent wall is required.

FINISH

Interior: 95%, reflective matte powder coated white paint

Exterior: Matte white, matte black or aluminum powder coating. Custom finishes are also available.

CONTROLS

Lumenwerx offers several options for integrating occupancy and daylight harvesting controls in our luminaires.

For latest information on sensors, click [here](#).



Standalone controls

An integrated standalone sensor controls the luminaire in which it is installed. Depending on the length, more than one sensor may be necessary and may control the entire luminaire, or just a section of it. These controls operate independently. Unless otherwise agreed, sensor location, blank size, and functionality of the sensor within the luminaire are selected by Lumenwerx. See client drawings for details.

One type is available:

ODS: An integral, daylight harvesting sensor with closed-loop operation dims the luminaire in which it is installed in order to compensate for available daylight. The sensor measures the combination of daylight and luminaire light reflected from horizontal surfaces below the luminaire. Initial onsite calibration is required via the use of provided remote control.

VIA 1.5 WALL



DIRECT/INDIRECT, DIRECT, INDIRECT
STATIC WHITE, BIOS

Connected controls

With connected controls, sensors or nodes installed in the luminaire form part of a larger control system infrastructure from manufacturers such as: Lutron, Encelium, Cooper Wavelinx, Acuity nLight, Casambi, Legrand, and others. These connected controls allow for a scalable system providing features like occupancy and daylight control, manual control, scheduling and configuration of various zones and scenes. Energy reporting and system monitoring are also possible. Specific capabilities depend on the control system being used. Consult factory for integrating connected controls in a wall fixture.

CONSTRUCTION

Housing: Extruded aluminum, up to 90% recycled content

Interior brackets: Die-formed cold rolled sheet steel

Joining system: Die-cast zinc

Reflectors: Die-formed cold rolled steel, 95% reflective matte white painted

Lens: Acrylic

Drop lens: Extruded with glued end caps

End caps: Die-cast aluminum

WEIGHT

Direct/Indirect	Direct or Indirect
4': 8.26 lbs - 3.75 kg	4': 7.16 lbs - 3.25 kg
8': 16.52 lbs - 7.5 kg	8': 14.32 lbs - 6.5 kg
12': 24.78 lbs - 11.25 kg	12': 21.48 lbs - 9.75 kg

CERTIFICATIONS

ETL: Rated for indoor dry/damp locations. Conforms to UL Standard 1598 and certified to CAN/CSA Standard C22.2 No. 250.0.

Declare: [LBC Red List Approved](#)

WARRANTY

Lumenwerx provides a five-year limited warranty on electrical and mechanical performance of the luminaires, including the LED boards, drivers, and auxiliary electronics. Lumenwerx will repair or replace defective luminaires or components at our discretion, provided they have been installed and operated in accordance with our specifications. Other limitations apply, please refer to the full warranty on our website.