

# VIA 2

ACOUSTIX - CHROMAWERX  
QUADRO - RGBW



# LUMENWERX

Project: \_\_\_\_\_

Type: \_\_\_\_\_



Section View

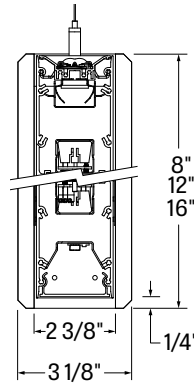

Via 2 Acoustix is an acoustic environmentally sound linear luminaire system for pendant installation available in set lengths or continuous runs. Via 2 Acoustix features numerous optical configurations, flush and drop diffuser as well as other light distributions which are difficult to achieve in such a compact acoustic luminaire. Via 2 Acoustix is available in Chromawerx QUADRO. Static White, Biologically Optimized White and Chromawerx DUO and SOLA are also available, see separate spec sheets.

## Order Guide

LUMINAIRE ID	DISTRIBUTION	OPTICS	LENS POSITION	LIGHT SOURCE	OUTPUT WATTAGE
<b>VIA2ACOP</b>	<b>D</b>	<b>HLO</b>			
VIA2ACOP - Via 2 Acoustix Pendant	D - Direct	HLO - High-Efficiency Lambertian Optic	FH - Flush 1.0D - 1.0" drop	QUADRO - Four-channel RGB with 3500K/80CRI RS - Red solid BS - Blue solid GS - Green solid	2.5WF <sup>1</sup> - 2.5W/ft output 3WF <sup>2</sup> - 3 W/ft output 6WF <sup>2</sup> - 6 W/ft output 9WF <sup>2</sup> - 9 W/ft output  <sup>1</sup> Available for solid colors only. <sup>2</sup> Available for QUADRO only.

LUMINAIRE LENGTH	LUMINAIRE HEIGHT	VOLTAGE	DRIVER	ELECTRICAL
Standard individual sections (nominal length): 4', 6', 8' Continuous runs: lengths over 8'; built with 4', 6', 8' sections  #FT <sup>3</sup> - Specify nominal length (#) in 2 foot increments  <sup>3</sup> Consult factory for other lengths.	8 - 8 inches 12 - 12 inches 16 - 16 inches	120 -120V 277 - 277V UNV - 120V-277V	DMX <sup>4,5</sup> - DMX DA <sup>4,6</sup> - DALI D1 <sup>6</sup> - 0-10V  <sup>4</sup> On-site commissioning is required. <sup>5</sup> To specify, see pages 6 to 11. <sup>6</sup> Available for solid colors only.	1 - 1 circuit 2 <sup>7</sup> - 2 circuits  <sup>7</sup> Available for 0-10V drivers, solid colors only.

MOUNTING	FIXTURE FINISH	FELT COLOR	OPTIONS	DMX WALL CONTROLS (OPTIONAL) <sup>11</sup>
	<b>W</b>			
53WAC36W <sup>8</sup> - 36" aircraft cable, white canopies (5" power + 3" non-power), white power cord 53WAC36B <sup>8</sup> - 36" aircraft cable, white canopies (5" power + 3" non-power), black power cord 55WSW18 - 18" white stem, white canopies (5" power + 5" non power)  <sup>8</sup> Power cord is 6" longer than suspension length. Consult factory for other lengths.  <a href="#">For all other options, refer to our Pendant Mounting Guide</a>	W - Matte white	<b>STANDARD COLORS</b> FWN LVN FON LEN ION CYN TBN PMN MDN FGN	<b>PREMIUM COLORS<sup>9,10</sup></b> PKN CDN IVN BHN OGN LCN SLN CFN LNN SYN CNN GRN LMN BLN GHN MON EGN NVN CLN ESN  <sup>9</sup> Please consult factory for more color options. <sup>10</sup> Lead time may vary.	FU120 - Fuse 120V FU277 - Fuse 277V TB# - T-bar caddy clip, specify grid size TG# - Tegular caddy clip, specify grid size ST - Screw slots caddy clip CU - Custom  WC1W - Wall controller 1 white WC1B - Wall controller 1 black WC2W - Wall controller 2 white WC2B - Wall controller 2 black  <sup>11</sup> For more information, see pages 6 to 11, or consult factory.

# VIA 2

ACOUSTIX - CHROMAWERX  
QUADRO - RGBW



Project: \_\_\_\_\_

Type: \_\_\_\_\_

# LUMENWERX

## Standard Color Options



**FWN** - FROST WHITE

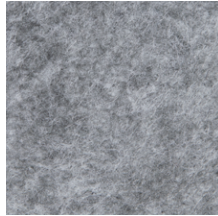

**FON** - FOG

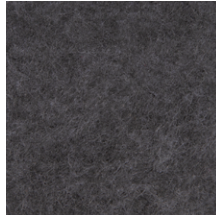

**ION** - IRON

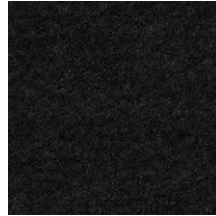

**TBN** - TRUE BLACK



**MDN** - MIDNIGHT BLUE



**LVN** - LAVENDER



**LEN** - LATTE



**CYN** - CHERRY



**PMN** - PLUM

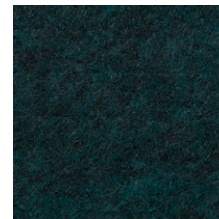

**FGN** - FOREST GREEN

## Premium Color Options\*



**PKN** - PAPRIKA



**OGN** - ORANGE



**LNN** - LEMON



**LMN** - LIME



**EGN** - EVERGREEN



**CDN** - CLOUDY



**LCN** - LICHEN

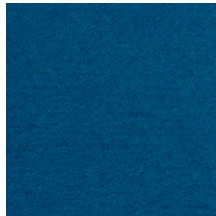

**SYN** - SKY



**BLN** - BLUEBERRY



**NVN** - NAVY



**IVN** - IVORY



**SLN** - STEEL



**CNN** - CARBON

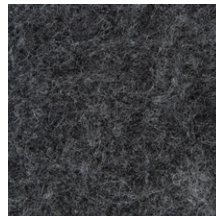

**GHN** - GRAPHITE

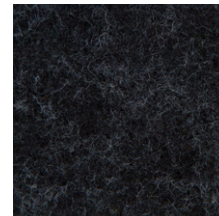

**CLN** - CHARCOAL



**BHN** - BLUSH



**CFN** - CAFÉ



**GRN** - GREIGE



**MON** - MOCHA



**ESN** - ESPRESSO

\*Please consult factory for more color options.  
\*Lead time may vary.

# VIA 2

ACOUSTIX - CHROMAWERX  
QUADRO - RGBW



# LUMENWERX

Project: \_\_\_\_\_

Type: \_\_\_\_\_

## DIMENSIONS

Front view

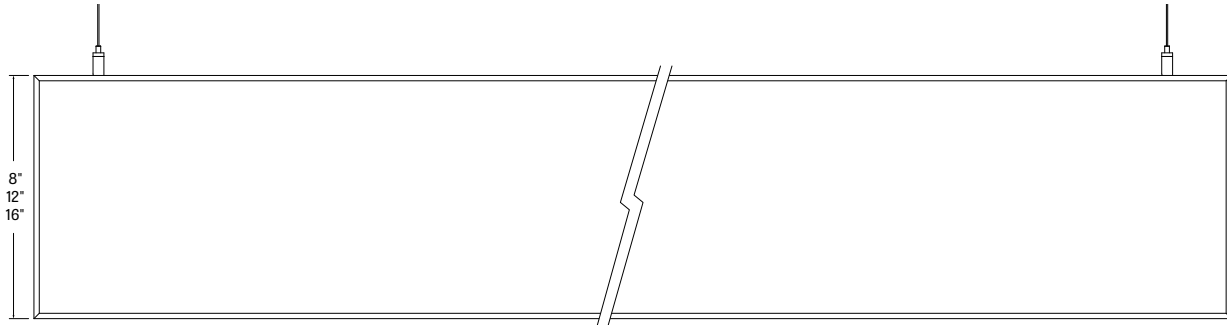

Side view

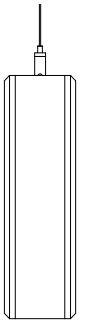

Bottom view

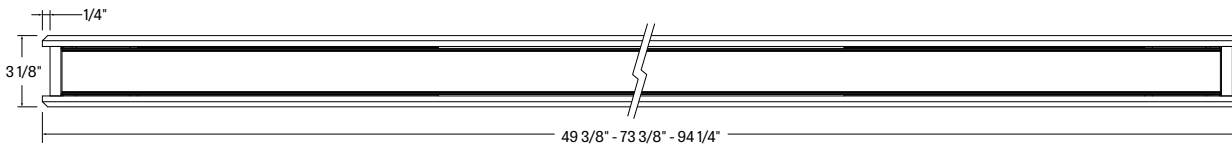



## ACOUSTIC CALCULATOR

Using the Lumenwerx Acoustix Value Calculator table, you can determine the number of acoustic luminaires required in a space by fixture type. We have three levels of recommended sound reduction: good, better, and best. Choosing one of these options will reduce the sound accordingly. The best option indicates the best acoustic improvement. Calculations are based on a standard ceiling height of 9 feet.



- 1 Calculate the square feet of your room (L x W).
- 2 Choose the level of acoustical improvement you are looking for, and find the corresponding value based on your room dimension and luminaire configuration.

% in reduction in reverberation time		
😊	GOOD	25%
😊😊	BETTER	40%
😊😊😊	BEST	50%

LENGTH	HEIGHT	Room dimensions under 300 sq ft			Room dimensions over 300 sq ft		
		GOOD 😊	BETTER 😊😊	BEST 😊😊😊	GOOD 😊	BETTER 😊😊	BEST 😊😊😊
4 Feet	8"	19	9	6	29	15	10
	12"	29	14	8	45	22	14
	16"	38	19	12	58	29	19
6 Feet	8"	28.5	13.5	9	43.5	22.5	15
	12"	43.5	21	12	67.5	33	21
	16"	57	28.5	18	87	43.5	28.5
8 Feet	8"	38	18	12	58	30	20
	12"	58	28	16	90	44	28
	16"	76	38	24	116	58	38

- 3 Use the Lumenwerx Acoustix Value Formula to determine the number of luminaires needed in the room.

**Square feet ÷ Value = Number of luminaires**

Example:

**Luminaires:** Via 2 Acoustix, 4 ft long, 16" high  
**Room square feet:** L: 20 ft x W: 18 ft = 360 sq ft  
**Desired acoustical improvement:** Better = 29  
**Number of luminaires needed in the room:** 360 ÷ 29 = **13 luminaires**

NOTES:  
 - You can mix lit and blank fixtures.  
 - Lumenwerx acoustic calculators were developed to act as a guide. For precise acoustic performance in a space, please consult an acoustician.

# VIA 2

ACOUSTIX - CHROMAWERX  
QUADRO - RGBW



# LUMENWERX

Project: \_\_\_\_\_

Type: \_\_\_\_\_

## Technical Specifications

### OPTICS

**High-Efficiency Lambertian Optic (HLO)** - shielding of diffusing 0.075" thick acrylic provides up to 88% transmission and good source obscuration. Matte white reflectors distribute LED output across the shielding. Luminaire brightness is controlled by the ratio of luminous flux to shielding area. HLO is available as a flush diffuser or as a drop diffuser, extending 1.5" below the luminaire housing. Drop diffuser is extruded with glued end caps.

### LIGHT SOURCE - LED

Custom linear array of mid-flux LEDs, comprised of an alternation of an RGB and a dedicated white LED. The white LED is used for when a static white CCT is required in the space. RGB LEDs are tightly binned for excellent color control between fixtures. The white LEDs have been tested in accordance with IESNA LM-80-08 and the results have shown L80 lumen maintenance greater than 60,000 hours. Absolute product photometry is measured and presented in accordance with IESNA LM-79, unless otherwise indicated.

### LUMINAIRE LENGTH

Via 2 Acoustix is made up of standard 4, 6, and 8 foot sections that may be joined together to create longer continuous run lengths. Exact run length must be noted in the product code. The minimum individual section available is 4 feet, and continuous run lengths can be ordered in 4, 6, or 8 foot sections.

All individual sections are joined together onsite using the joiner kits provided. Lumenwerx joiner kits are extremely simple to work with in the field and result in a fixture that appears virtually seamless with no light leak at any connection.

### ELECTRICAL

#### DMX

Factory-set, adjustable output current, multi-channel LED driver with universal (120-277VAC) input. Using DMX wall controls (optionally supplied by Lumenwerx) or an existing DMX control system, four channels of LEDs (Red/Green/Blue/White) are independently adjustable. Each DMX driver has multiple output channels that can be independently addressed at the factory or on-site using built-in RDM (Remote Device Management) functionality. Dimming range from 100%-0%. At maximum driver load, efficiency<89%, PF>0.9, THD<20%.



### CHROMAWERX - QUADRO

Chromawerx QUADRO is a four-channel control that operates an RGBW LED array and addresses the need for more expressive color in architectural applications. The DMX driver supports familiar programming tools for both dynamic multi-hued color and precise white color point control. While a typical user interface will be a DMX controller by others, Lumenwerx also offers a simple control station for stand-alone color changing applications.

# VIA 2

ACOUSTIX - CHROMAWERX  
QUADRO - RGBW

# LUMENWERX



Project: \_\_\_\_\_

Type: \_\_\_\_\_

## Technical Specifications

### MOUNTING OPTIONS

**For cable-mounted fixtures** - 53WAC36 (5" white canopy for all power mounting point, 3" white canopy for non power mounting point, and a 3/6" cable)

**For stem mounted fixtures** - 55WSW18 (5" white canopy for all power mounting point, and non power mounting point, and a 1/8" white stem)

Caddy clips, if required specify under OPTIONS

### WEIGHT

**Via 2 Acoustix 4ft** - 13.23lbs - 6kg

**Via 2 Acoustix 8ft** - 26.46lbs - 12kg

### CONSTRUCTION

**Housing** - Extruded aluminum (0.095" nominal) up to 90% recycled content

**Interior brackets** - Die formed cold rolled sheet steel 18 gauge thick

**Joining system** - Die cast zinc (0.95" nominal)

**Reflectors** - Cold rolled steel 0.024" thick precisely die formed, 95% reflective matte white painted

**Diffuser** - 0.075" thick acrylic, 88% transmission

**Drop diffuser** - extruded with glued end caps

**End caps** - Die cast aluminum (0.95" nominal)

**Hanger** - Chromed Griplock securely attached with spring steel hardware in end caps and/or joiners

**Aircraft cable suspension** - 7x7 braids aluminum aircraft cable 0.06" thick

**Stem** - 0.5" diameter threaded steel tube matte white or aluminum powder coating. Custom finishes are also available.

### FINISH

**Interior** - 95%, reflective matte powder coated white paint

**Exterior** - matte white powder coating

### ACOUSTIC FINISH

Material is 100% polyester containing up to 50% of recycled plastic bottles (PET) with an ASTM E-84 Class A fire rating and is moisture resistant.

### CARE

Remove dust and debris with a clean, dry, soft, lint-free cloth, or vacuum.

### ENVIRONMENT

Ambient temperature at fixture location shall not exceed 30°C/86°F. For indoor use only.

### CERTIFICATIONS

**ETL** - Rated for Indoor Dry/Damp locations. Conforms to UL Standard 1598 and certified to CAN/CSA Standard C22.2 No. 250.0.

### WARRANTY

Lumenwerx provides a five-year limited warranty of electrical and mechanical performance of the luminaires, including the LED boards, drivers, and auxiliary electronics. Lumenwerx will repair or replace defective luminaires or components at our discretion, provided they have been installed and operated in accordance with our specifications. Other limitations apply, please refer to the full warranty on our website. Wall controllers are covered by the manufacturer warranty.



**WELL for Light** - The WELL building standard focuses on light quality in several features. There are three categories that are fully attributed to the construction and features of a luminaire. In WELL V1, it's Feature 54 Circadian Lighting, Feature 55 Glare Control, and Feature 58 Color Quality. In WELL V2, it's Feature L03 Circadian Lighting, Feature L04 Glare Control, and Feature L07 Electric Light Quality.

This fixture meets Features:

- Feature 55 or L04 meets WELL glare category (a-c-d)
- Feature 58 or L07 when 90CRI is selected

All LED drivers used at Lumenwerx are deemed to have a low risk level of flicker, of 5 % or less below 90Hz operational as defined by IEEE standard 1789-2015 LED.



**WELL for Sound** - This luminaire is recommended for use as an acoustical absorption surface to limit reverberation times (RT) in a given space. This luminaire contributes to noise reduction and vibration dampening to promote focus and concentration. Reverberation needs to be calculated in each space based on the materials used.

**For more information please contact [well@lumenwerx.com](mailto:well@lumenwerx.com).**



Project: \_\_\_\_\_

Type: \_\_\_\_\_

## QUADRO DMX SPECIFICATION

A qualified DMX integrator is required to assure proper installation and commissioning of the DMX network. **When placing the PO, please provide the contact information of your DMX integrator.**

Please answer the following questions to help us identify your DMX network requirements.

YES

Do you require a wall controller provided by Lumenwerx?

NO

DMX controller supplied by Lumenwerx

DMX control system supplied by others. Lumenwerx will supply DMX-enabled fixtures with default DMX addressing. See following pages for technical DMX informations. ✓

**How many zones do you have?**

A zone consists of one or more luminaires behaving identically.



1 Zone



2 Zones

**How to calculate the required number of drivers:**

per 4' fixture

**Driver**

1x driver

Less than 12.5W/ft, direct only

per 4' fixture

**Driver**

2x driver

Above 12.5W/ft or for all direct/indirect fixture

To Calculate # of drivers

1 Zone

2 to 3 Zones

4 or more Zones

Do you have more than 32 drivers in total?

NO

YES

Order a standard Lumenwerx wall controller type 1.

### WALL CONTROLLER

**WC1W** - Single zone wall controller white  
**WC1B** - Single zone wall controller black

Add the control code at the end of your order code.

Please provide a fixture layout or RCP (Reflected Ceiling Plan) showing the locations of the DMX fixtures, zones and the DMX wall controller.

Refer to your DMX integrator for the installation. ✓

Subject to factory evaluation. Please contact our controls specialist at [controls@lumenwerx.com](mailto:controls@lumenwerx.com). Additional cost and equipment will be required. ✓

NO

YES

Order a standard Lumenwerx wall controller type 2.

### WALL CONTROLLER

**WC2W** - 3 zone wall controller white  
**WC2B** - 3 zone wall controller black

Add the control code at the end of your order code.

Please provide a fixture layout or RCP (Reflected Ceiling Plan) showing the locations of the DMX fixtures, zones and the DMX wall controller.

Refer to your DMX integrator for the installation. ✓

Subject to factory evaluation. Please contact our controls specialist at [controls@lumenwerx.com](mailto:controls@lumenwerx.com). Additional cost and equipment will be required. ✓

Subject to factory evaluation and approval. Please contact our controls specialist at [controls@lumenwerx.com](mailto:controls@lumenwerx.com). Additional cost and equipment will be required. ✓

# VIA 2

ACOUSTIX - CHROMAWERX  
QUADRO - RGBW



Project: \_\_\_\_\_

Type: \_\_\_\_\_

# LUMENWERX

## GENERIC DMX NETWORK ARCHITECTURE

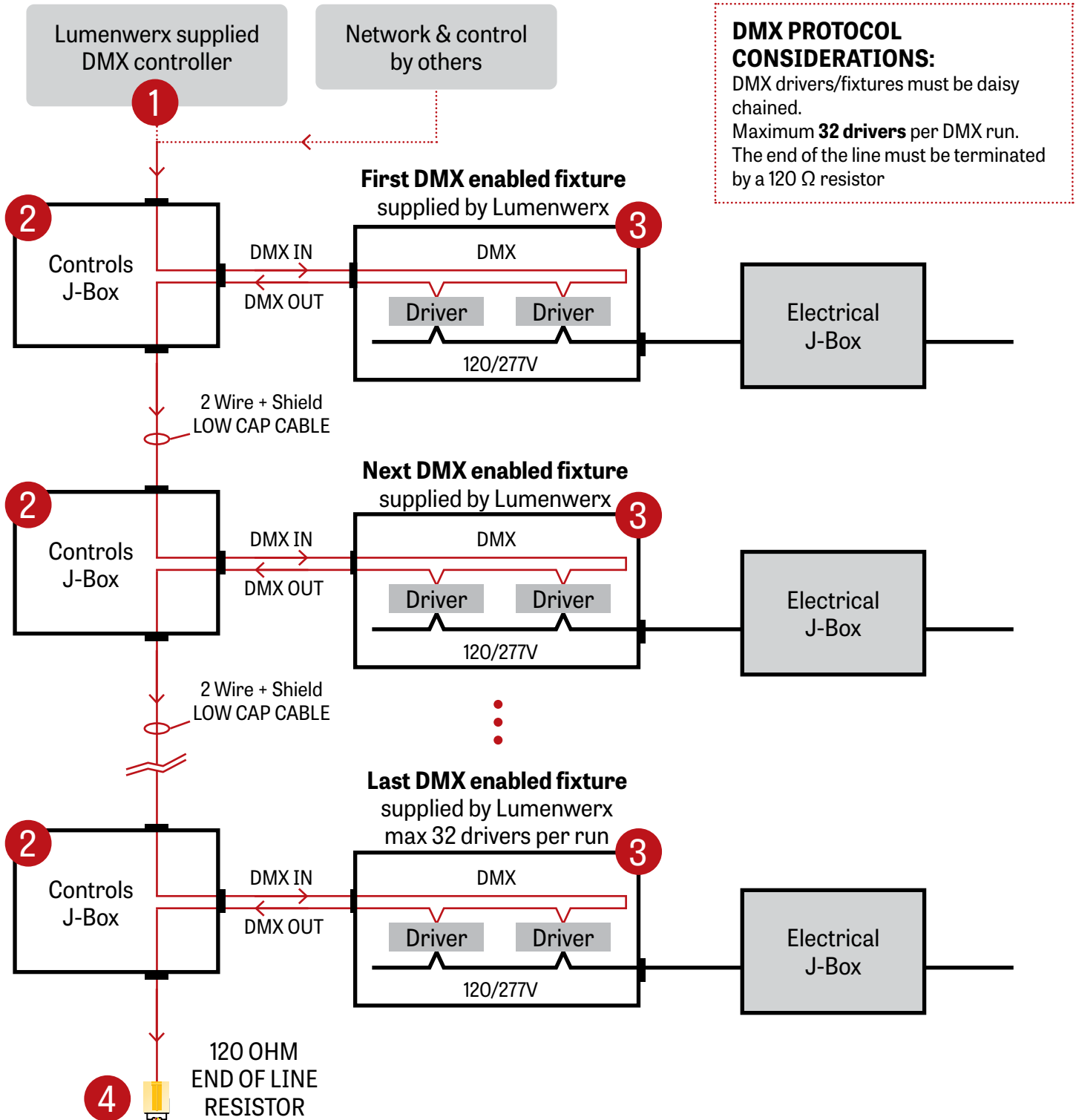

# VIA 2

ACOUSTIX - CHROMAWERX  
QUADRO - RGBW



Project: \_\_\_\_\_

Type: \_\_\_\_\_

# LUMENWERX

## 1 LUMENWERX SUPPLIED DMX CONTROLLER

To the first fixture

WALL BOX SUPPLIED BY OTHERS

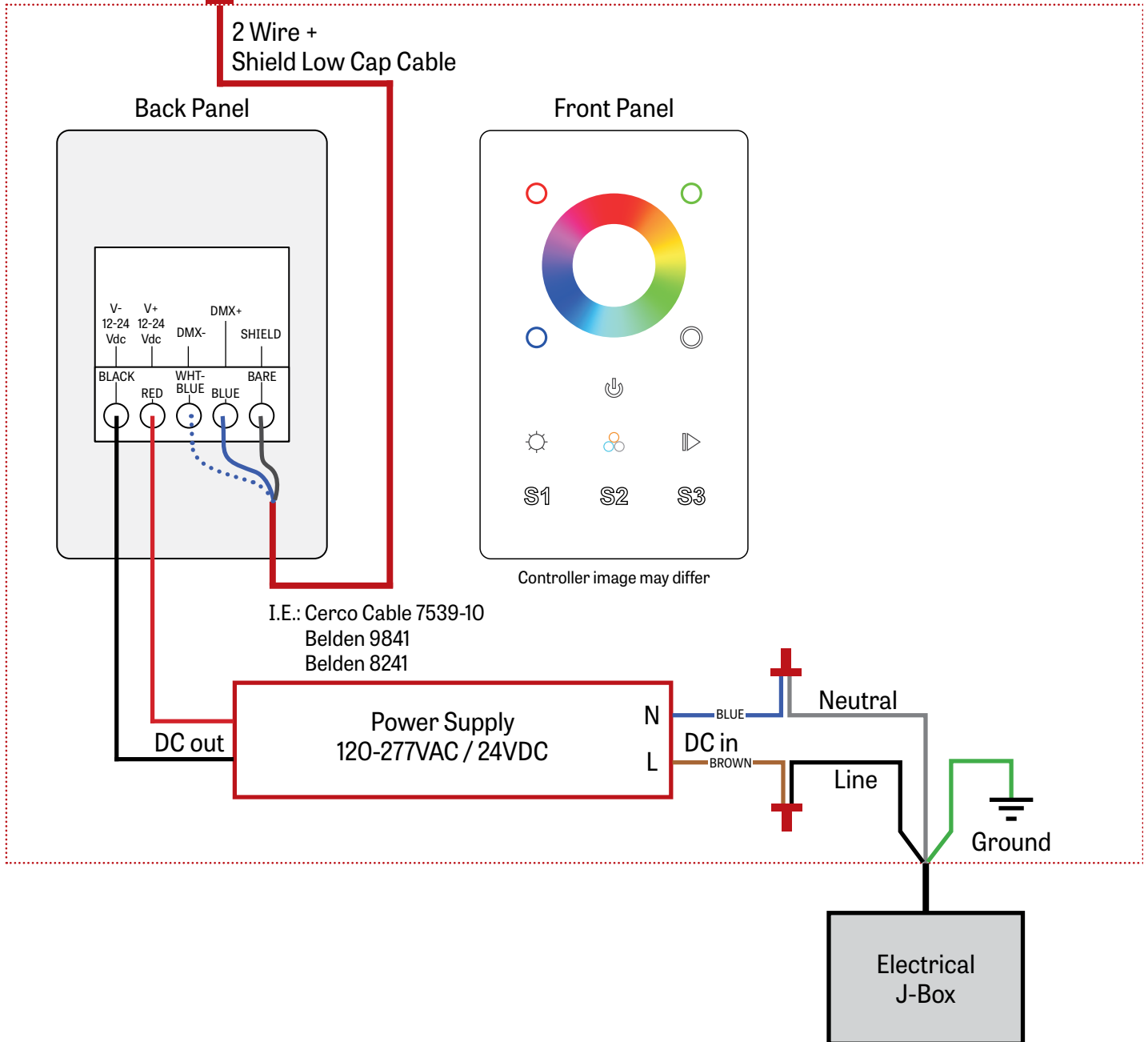



Project: \_\_\_\_\_

Type: \_\_\_\_\_

## 2 J-BOX DMX DAISY CHAIN DETAIL

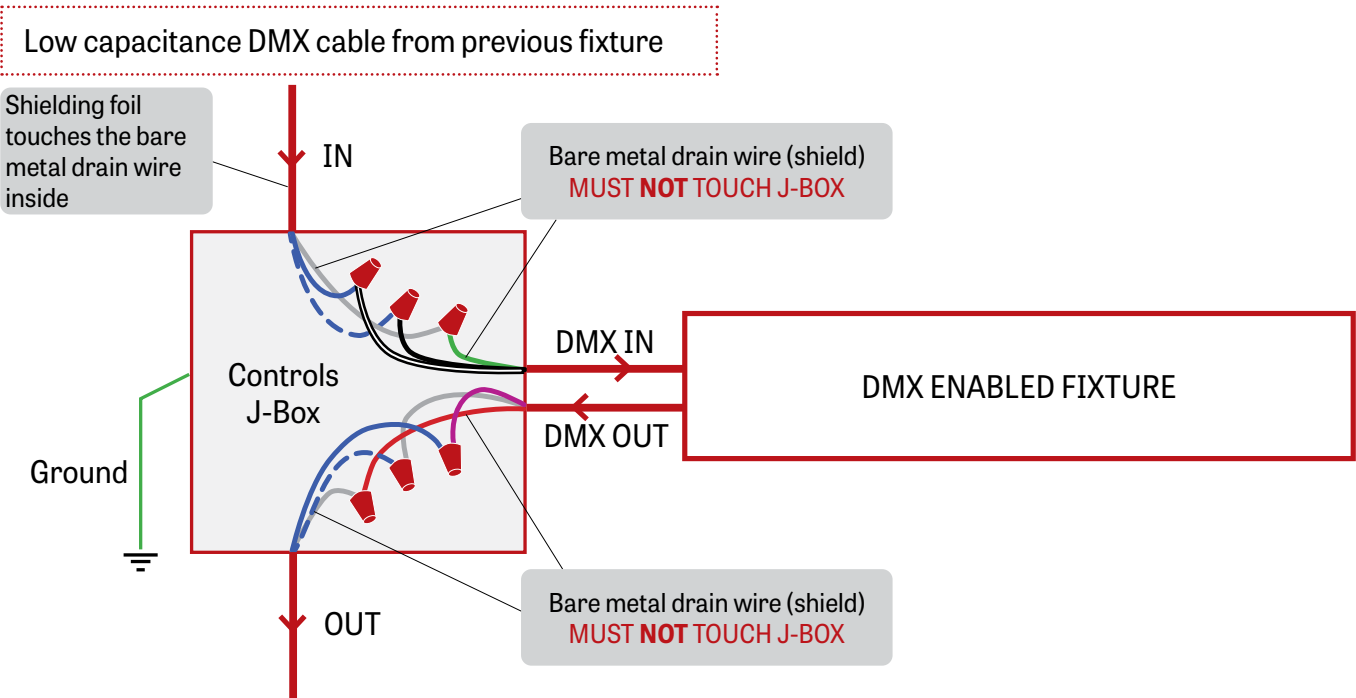

Low capacitance DMX cable to next fixture

## 3 DMX CONNECTION PENDANT & WALL

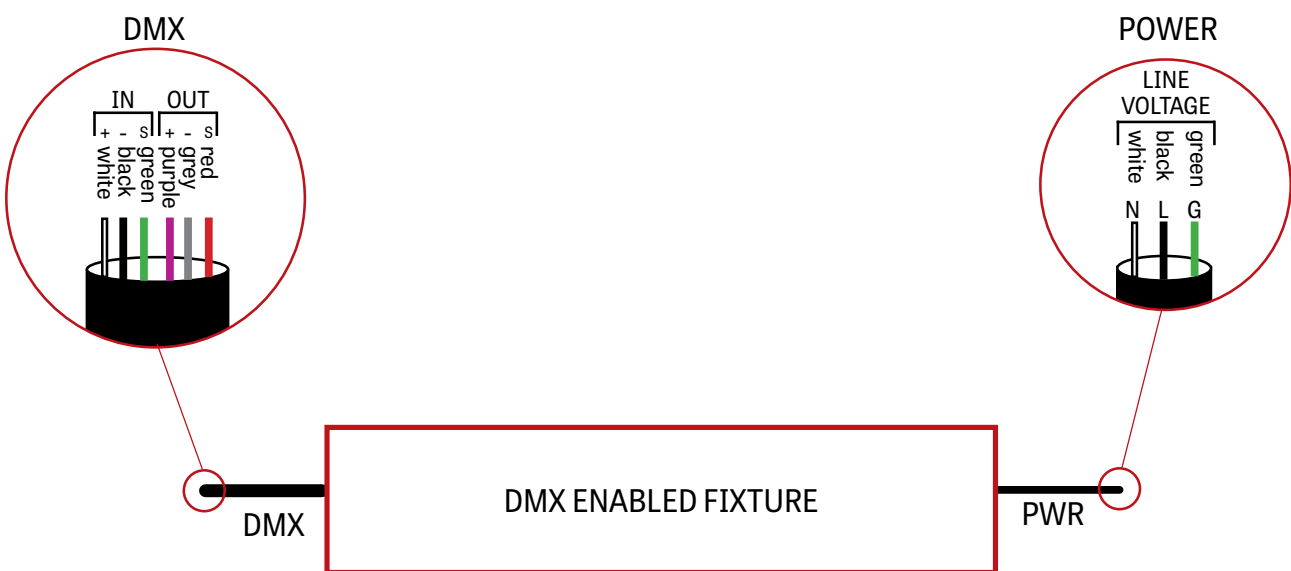

# VIA 2

ACOUSTIX - CHROMAWERX  
 QUADRO - RGBW

# LUMENWERX



Project: \_\_\_\_\_

Type: \_\_\_\_\_

## 4 DMX LAST FIXTURE DETAIL

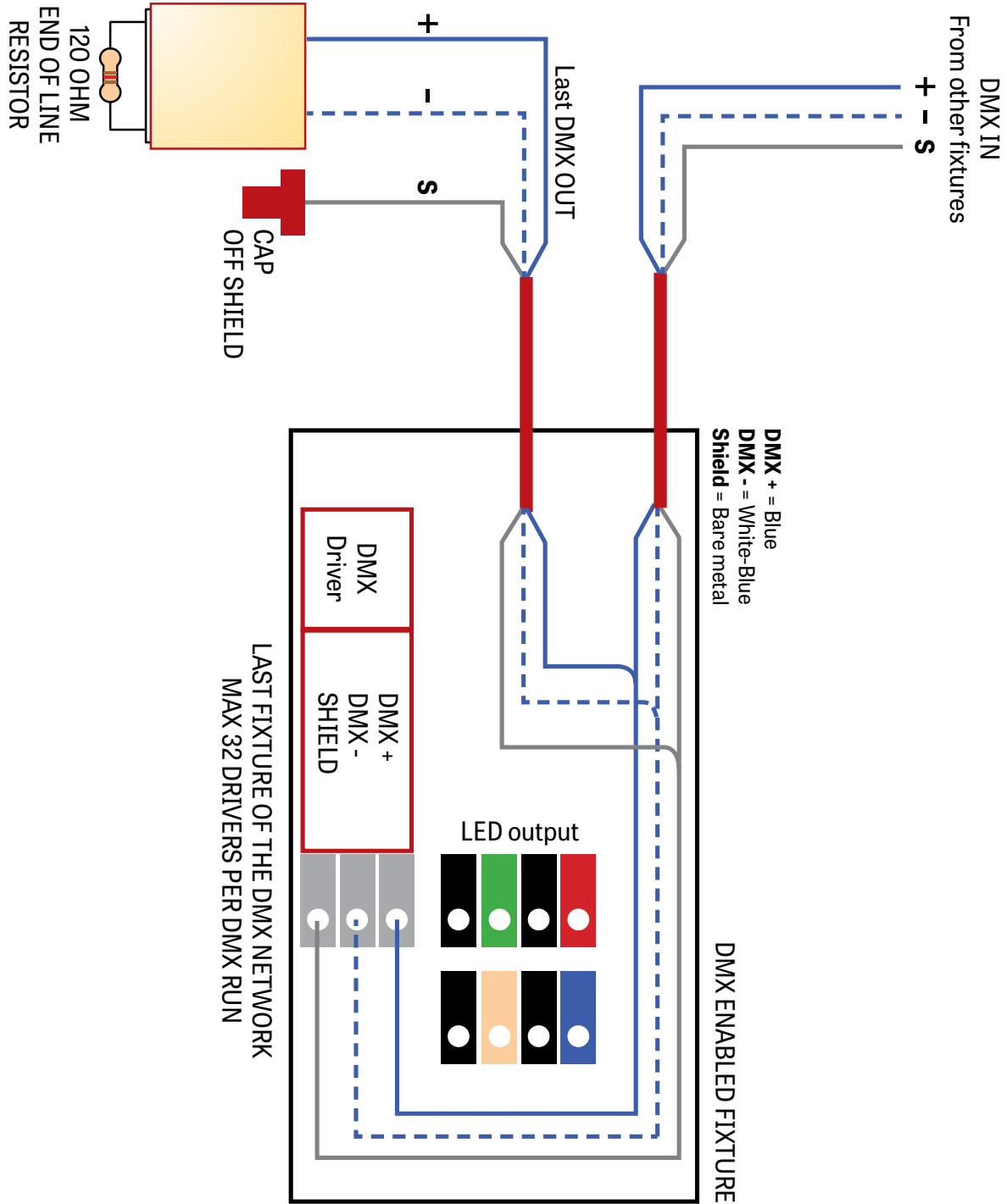



Project: \_\_\_\_\_

Type: \_\_\_\_\_

## DMX WALL CONTROLLER

### WC1

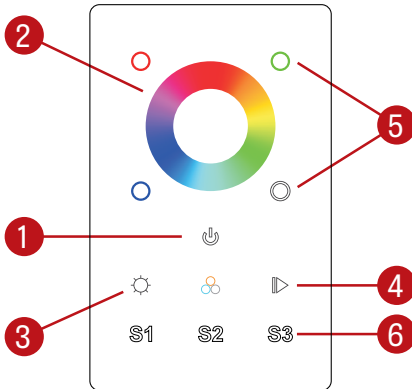

- (1) Power: Use this button to turn ON or OFF the RGBW fixture.
- (2) Color Wheel: The wheel is used to rapidly select a color (RGB colors only).
- (3) Brightness (RGB): Hold down this button to either increase or decrease the brightness of the current RGB selection. White will not be affected by the RGB brightness button.
- (4) Color Cycle: This button will start an animation, rotating between Reds Greens and Blues, the arrows allow the user to speed up or slow down the animation.
- (5) Individual Colors: By pressing and holding a color it will be possible to brighten or dim it. Quickly pressing a color will turn it OFF or turn it ON to its previous dim level.  
White: In order to activate or deactivate and dim the White channel, the White button needs to be used.
- (6) Scenes: By holding down one of the scenes button, the current color selection is saved. It can be later accessed by quickly pressing on one of the Scene buttons.

### WC2

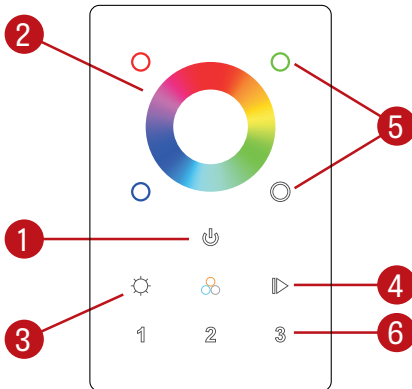

- (1) Power: Use this button to turn ON or OFF the RGBW fixture.
- (2) Color Wheel: The wheel is used to rapidly select a color (RGB colors only).
- (3) Brightness: Hold down this button to either increase or decrease the brightness of the current RGB selection. White will not be affected by the RGB brightness button.
- (4) Color Cycle: This button will start an animation, rotating between Reds Greens and Blues, the arrows allow the user to speed up or slow down the animation.
- (5) Individual Colors: By pressing a color it will be possible to brighten or dim that specific color.  
White: In order to activate or deactivate and dim the White channel, the White button needs to be used.
- (6) Zone: By holding down one of the zone buttons, a zone can be selected and controlled.

### Default DMX Addresses:

- 1 Red
- 2 Green
- 3 Blue
- 4 White