

# VIA 2 PERIMETER

RECESSED PATTERN  
CHROMAWERX - SOLA, DUO



Project: \_\_\_\_\_  
 \_\_\_\_\_  
 Type: \_\_\_\_\_  
 \_\_\_\_\_



Via 2 Perimeter Deep Pattern

## DESCRIPTION

Via 2 Perimeter creates a continuously illuminated "slot" at the wall/ceiling intersection. Lighted corners with adjustable end sleeves are available. Via Perimeter installs in grid or drywall ceilings in a choice of three arrangements: level, shallow 1", and deep 3 ¼".



## Order Guide

A drawing of your pattern is required - anything from a line drawing to an architectural drawing.

LUMINAIRE ID		OPTIC	LIGHT SOURCE <sup>1</sup>		CRI	
		<b>HLO</b>				
<b>V2PERLPAT</b> - Via 2 Perimeter Level Pattern <b>V2PERSPAT</b> - Via 2 Perimeter Shallow Pattern <b>V2PERDPAT</b> - Via 2 Perimeter Deep Pattern		<b>HLO</b> - High-Efficiency Lambertian Optic	<b>SOLA</b> - Dim-to -warm single channel control 35K to 22K <b>DUO</b> - Tunable white 2-channel control 65K to 27K		<b>80CRI</b> - 80+ CRI <b>90CRI</b> - 90+ CRI	
<small><sup>1</sup>Static white and Chromawerx QUADRO also available. Consult other spec sheets.</small>						
LUMEN PACKAGE		PATTERN LENGTH	CORNER TYPE <sup>3</sup>		VOLTAGE	
<b>350LMF</b> - Low output 350 lm/ft <b>500LMF</b> - Medium output 500 lm/ft <b>750LMF</b> - High output 750 lm/ft		<b>##FT##IN(##X##FT##IN-##X##FT##IN-...)</b> <sup>2</sup> - ##FT##IN: total nominal length of pattern in feet and/or inches #X: quantity of each section #FT##IN: nominal length of each section in feet and/or inches  Continuous runs: lengths over 12'  <sup>2</sup> Minimum fixture length is 4'.	<b>#LEVI2C(A##)</b> - 2-way leveled inside corner <b>#LEVO2C(A##)</b> - 2-way leveled outside corner  <sup>3</sup> Specify quantity (#) and angle (A##) for each required corner type. If more than one option is specified, separate codes with a "+", e.g. 1LEVI2C(A90)+2LEVO2C(A90). <sup>4</sup> Minimum angle is 30°.		<b>ANGLE (A##):</b> <b>(A90)</b> - 90° <b>(A##)</b> <sup>4</sup> - Custom  <b>120V</b> - 120V <b>277V</b> - 277V <b>UNV</b> - 120V-277V	
DRIVER <sup>5</sup>		ELECTRICAL	MOUNTING	FINISH	OPTIONS <sup>8</sup>	ADJUSTABLE SLEEVE (optional) <sup>11</sup>
		<b>1C</b>				
<b>SOLA</b> <b>SDI</b> - Single 0-10V input  <sup>5</sup> PoE (Power-over-Ethernet) compatible. Consult factory for details. <sup>6</sup> For more information, see pages 8 to 13. <sup>7</sup> On-site commissioning is required.		<b>1C</b> - 1 circuit	<b>TG9</b> - Tegular 9/16" <b>TG15</b> - Tegular 15/16" <b>TB9</b> - T-bar 9/16" <b>TB15</b> - T-bar 15/16" <b>ST</b> - Screw slot T-bar <b>DTR</b> - Trim <b>DTL</b> - Trimless <b>DMF</b> - Drywall mud flange	<b>W</b> - Matte white <b>CF#</b> - Custom finish, specify RAL#	<b>NEF</b> <sup>9,10</sup> - No end flanges <b>FEP</b> <sup>10</sup> - Flush end plates <b>FUI20</b> - Fuse 120V <b>FU277</b> - Fuse 277V <b>FWC</b> - Flexible whip cable (6' std) <b>CP</b> - Chicago Plenum <b>NA</b> - None  <sup>8</sup> Separate codes with a "+" if more than one is specified. <sup>9</sup> For wall-to-wall installations. <sup>10</sup> See page 4 for details.	<b>#TES</b> - Adjustable end sleeve, specify quantity (#) <b>#TMS</b> <sup>12</sup> - Adjustable mid sleeve, specify quantity (#) <b>NA</b> - None  <sup>11</sup> See page 5 for details. <sup>12</sup> Minimum 6' fixture. Maximum 1 sleeve per section.

## Accessories

Optional, order separately

WALL CONTROLLER <sup>13</sup>	
<b>DMX</b>	<b>DDI</b>
<b>WCW##FT</b> <sup>14</sup> - DMX wall controller white <b>WCB##FT</b> <sup>14</sup> - DMX wall controller black	<b>TWCW##FT</b> <sup>15</sup> - Dual 0-10V wall controller white <b>TWCB##FT</b> <sup>15</sup> - Dual 0-10V wall controller black
<sup>13</sup> Specify wire length (##) in feet. <sup>14</sup> Available with DMX only. For more information, see pages 8 to 13, or consult factory. <sup>15</sup> Available with DDI only. For more information, see page 14, or consult factory.	



# VIA 2 PERIMETER

RECESSED PATTERN  
CHROMAWERX - SOLA, DUO



## Dimensions

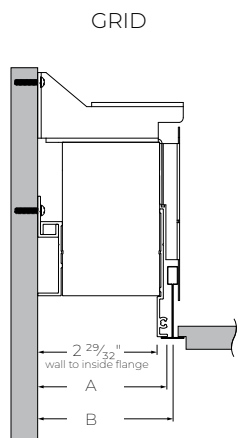
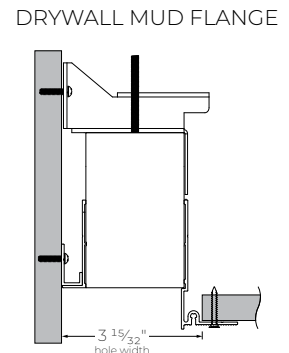
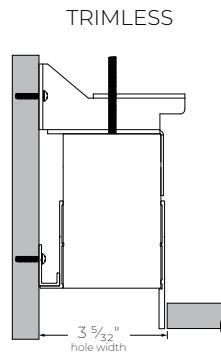
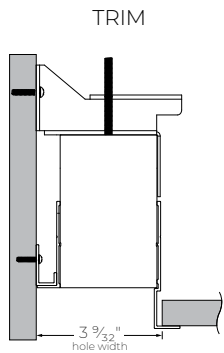
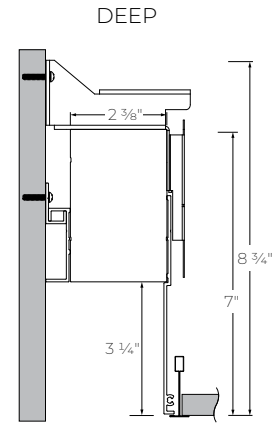
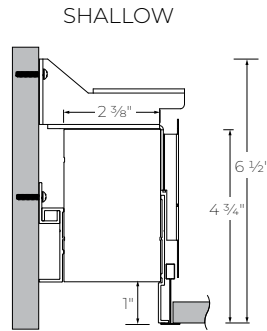
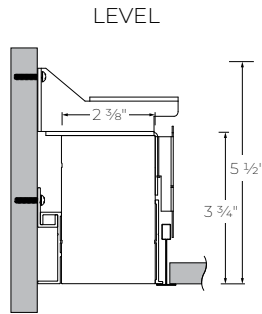

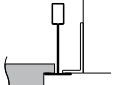
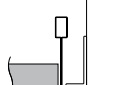
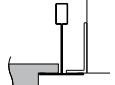
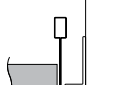
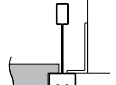
	 TC9 Tegular 9/16"	 TB9 T-bar 9/16"	 TG15 Tegular 15/16"	 TB15 T-bar 15/16"	 ST Screw slot T-bar
A wall to flange	3 5/32"		3 9/32"		3 5/32"
B wall to T-bar	3 7/32"		3 11/32"		3 7/32"

# VIA 2 PERIMETER

RECESSED PATTERN  
CHROMAWERX - SOLA, DUO



## Pattern Layout

### CORNER TYPES

#### LEVELED INSIDE CORNER

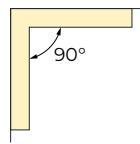

1LEVI2C(90)

#### LEVELED OUTSIDE CORNER

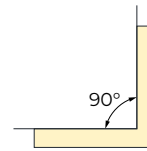

1LEVO2C(90)

2-way

### EXAMPLES

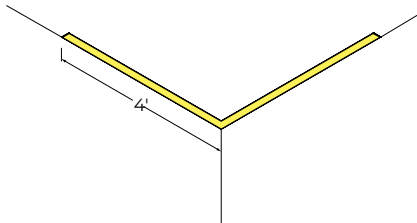

8FT(2X4FT)-1LEVI2C(90)

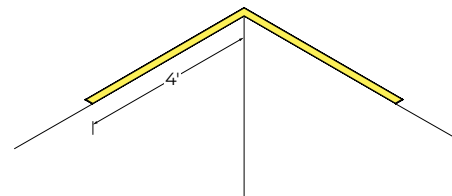

8FT(2X4FT)-1LEVO2C(90)

## Photometrics

Values calculated based on a 4' fixture at 3500K.

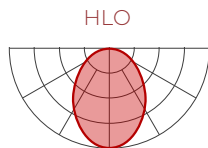

LM/FT	W/FT	LM/W
350	3.3	103
500	5	101
750	7.4	102

### MULTIPLIER TABLES

Use these tables to get results for different color temperatures.

#### SOLA

CCT	WATTS	LPW
	80+ CRI / 90+ CRI	80+ CRI / 90+ CRI
3500K	1.00	1.00

#### DUO

CCT	WATTS	LPW
	80+ CRI / 90+ CRI	80+ CRI / 90+ CRI
2700K	1.05	0.95
6500K	1.00	1.00



# VIA 2 PERIMETER

RECESSED PATTERN  
CHROMAWERX - SOLA, DUO



## End Configurations

STANDARD

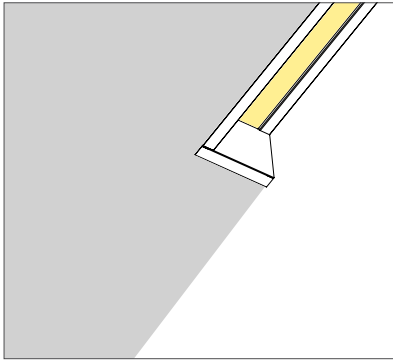

OPTIONS

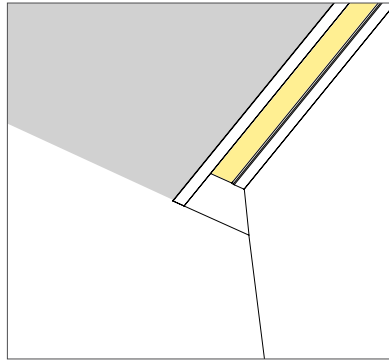

NEF - No end flanges

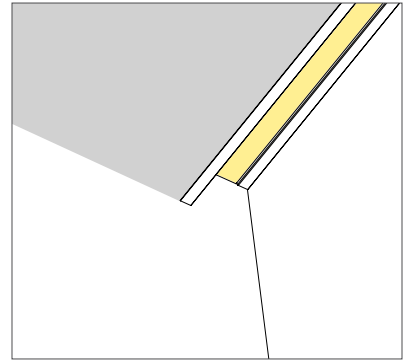

FEP - Flush end plates

# VIA 2 PERIMETER

RECESSED PATTERN  
CHROMAWERX - SOLA, DUO



## Adjustable End Sleeve - TES

Adjustable end sleeve (TES) is designed to provide on-site luminaire adjustability of +2.5" to -4.5". A sleeve accommodates an easy installation and maintenance. Please refer to the [End Sleeve Adjustment Installation Instructions](#) for more details.

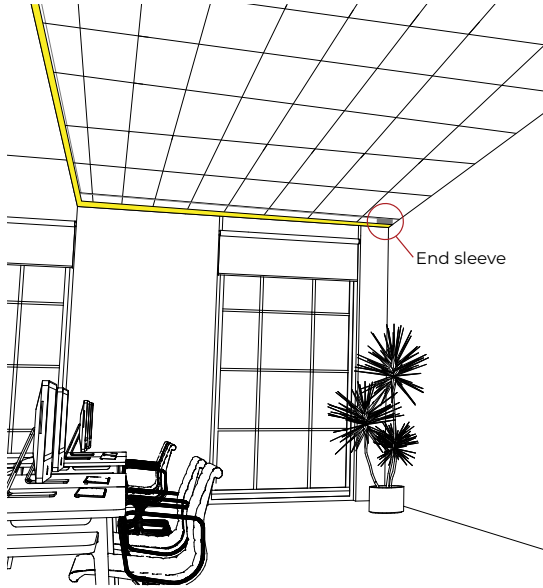

X = Fixture measure provided by client.  
X + 2.5" = Measurement built and supplied.

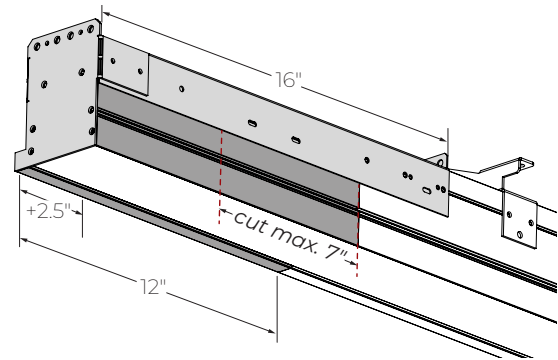
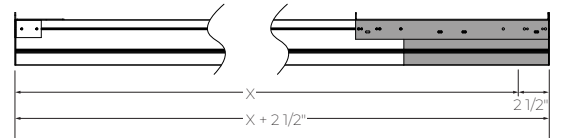

## Adjustable Mid Sleeve - TMS

Adjustable mid sleeve (TMS) is designed to provide on-site luminaire adjustability of +2.5" to -4.5". A sleeve accommodates an easy installation and maintenance. Please refer to the [Mid Sleeve Adjustment Installation Instructions](#) for more details.

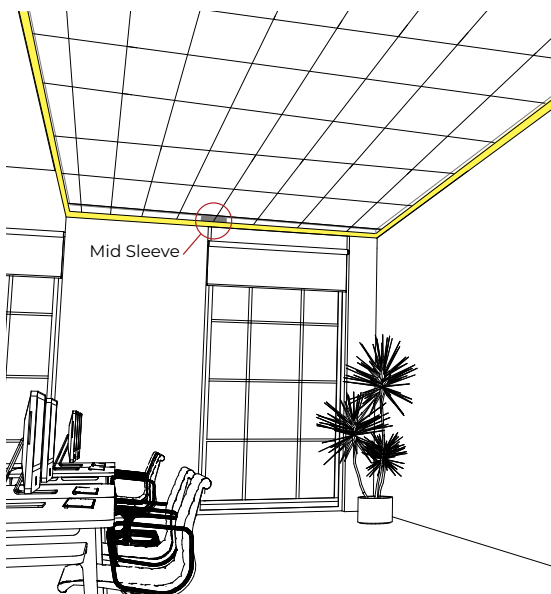

X = Fixture measure provided by client.  
X + 2.5" = Measurement built and supplied.

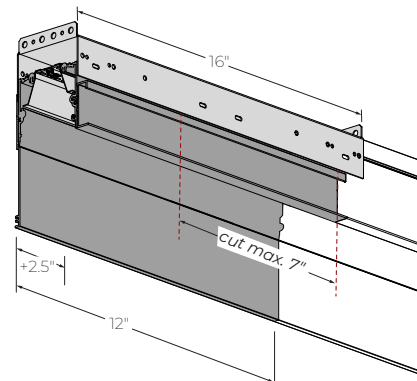
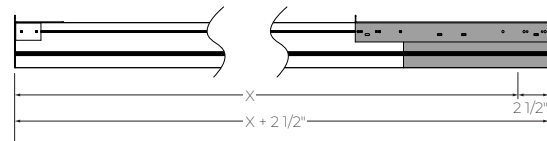

# VIA 2 PERIMETER

RECESSED PATTERN

CHROMAWERX - SOLA, DUO



## Technical Specifications

### OPTIC

#### High-Efficiency Lambertian Optic (HLO)

The High-Efficiency Lambertian Optic (HLO) uses matte white reflectors to distribute LED output across 0.075" acrylic shielding, providing up to 88% transmission and good obscuration. Luminaire brightness is controlled by the flux-to-shielding area ratio.

### LIGHT SOURCE

Custom linear array of alternating color temperature mid-flux LEDs are mounted directly to the housing for optimal thermal performance. For the DUO products, a color temperature range from 6500K-2700K is achievable with color points on or below the black body curve. For the SOLA products, a color temperature range from 3500K-2200K is controlled synchronously with intensity. Color consistency between fixtures is maintained to within 3 SDCM. LEDs operate at reduced drive current to optimize efficacy and lumen maintenance. All LEDs have been tested in accordance with IESNA LM-80-08 and the results have shown L80 lumen maintenance greater than 60,000 hours. Absolute product photometry is measured and presented in accordance with IESNA LM-79, unless otherwise indicated.

#### Chromawerx SOLA

It is a single-channel control that dims output while warming the color temperature in a pre-determined relationship. A simple analog control sends a common signal to dual output digital drivers, which are programmed to adjust a specially populated LED array to emulate the effect of dimming a filament source. Dimming range is programmable but the default option runs from 3500K at 100% of full power to 2200K at 5% of full power. CRI is maintained above 80 throughout the dimming range.

#### Chromawerx DUO

It is a two-channel control. It uses an analog (0-10V) protocol for separate control of luminaire CCT and intensity or a digital (DMX, DALI and LD2) protocol for synchronous control of both warm and cool LED arrays to enable the user to set color temperature and light output. Commonly called "tunable white", Chromawerx two-channel control provides the range of cool (6500K) to warm (2700K) color that can be useful for helping to entrain circadian rhythms, stimulate alertness for improved educational and work productivity, and compensate for jet lag, among other applications. The Chromawerx drivers are programmed to limit maximum light output and power usage across all color temperatures. CRI is maintained above 80. When paired with DALI drivers (DDA/DDA8), color tuning follows a linear dimming curve.

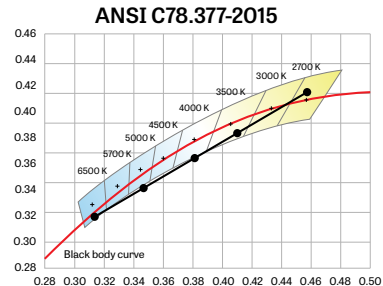

### PATTERN LENGTH

All individual sections are joined together onsite using the joiner kits provided. Lumenwerx offers joiner kits that are extremely simple to work with in the field and result in a fixture that appears virtually seamless with no light leak at any connection.

### ELECTRICAL

#### SOLA

##### SD1

Factory-set, adjustable output current LED driver with universal (120-277 VAC) input. Using a single 0-10V control signal, the light output warms in color temperature as it dims down to 1% and 2200K. At maximum driver load, efficiency<86%, PF>0.9, THD<20%.

#### DUO

##### DMX

Factory-set adjustable output current electronic driver with 120-277 VAC line input. Using DMX wall controls (optionally supplied by Lumenwerx) or an existing DMX control system, both channels of LEDs are independently adjustable. Each DMX driver can be independently addressed using the built-in RDM (Remote Device Management) in the field. Dimming down to 1% is attainable. Rated life (90% survivorship) of 50,000 hours at 50°C maximum ambient temperature. At maximum driver load, efficiency<84%, PF>0.9, THD<20%.

##### DALI

Factory-set adjustable output current electronic driver with 120-277 VAC line input. Using an existing DALI control system (supplied by others), one control channel adjusts the fixture color temperature, and the other control channel adjusts fixture brightness. With DALI Type 6, two DALI addresses are required to control both channels. With DALI Type 8, one DALI address is required to control both channels. Dimming down to 1% is attainable. Rated life (90% survivorship) of 50,000 hours at 50°C maximum ambient temperature. At maximum driver load, efficiency<84%, PF>0.9, THD<20%.

# VIA 2 PERIMETER

RECESSED PATTERN

CHROMAWERX - SOLA, DUO



## DD1

Factory-set adjustable output current LED driver with universal (120-277 VAC) input. Controlled via two individual 0-10V signals, one for setting light output down to a minimum of 1% and the other for adjusting the CCT (default range of 6500K-2700K). Rated life of 50,000 hours at 70°C maximum driver case temperature and 100% load conditions. Typical efficiency of 86%, PF>0.9, THD<20% at 100% load conditions.

## LD2

Lutron DALI-2 digital drivers provide a high-performance tunable white solution with single-address digital control. Guaranteed performance and compatibility when used with Lutron DALI-2 controls.

## **PoE**

Depending on the PoE manufacturer selected, Lumenwerx will install the node in factory as either integral to the luminaire or as a remote module. Factory programming of the PoE node may or may not enable the following functionalities: lumen package, DUO (tunable white), QUADRO (RGBW), emergency battery backup, and sensor integration. These must be addressed and evaluated on a case-by-case basis.

## **MOUNTING**

Recessed fixtures can be mounted into exposed or concealed T-bar or tegular ceiling, as well as in ceilings with trim, trimless, or mud flange options.

## **FINISH**

**Interior:** 95%, reflective matte powder coated white paint

**Exterior:** Matte white powder coating.

Custom finishes are also available.

## **CONSTRUCTION**

**Housing:** Extruded aluminum, up to 90% recycled content

**Interior brackets:** Die-formed cold rolled sheet steel

**Joining system:** Die-cast zinc

**Reflectors:** Flat rolled aluminum sheet or die-formed cold rolled steel, 95% reflective matte white painted

**Lens:** Acrylic

**Recessed flanges:** Extruded aluminum, up to 90% recycled content

**End plate:** Die-formed cold rolled sheet steel

## **MAINTENANCE**

LED boards are housed in a removable cartridge for easy replacement. Driver is accessible from below.

## **CERTIFICATIONS**

**ETL:** Rated for indoor dry/damp locations. Conforms to UL Standard 1598 and certified to CAN/CSA Standard C22.2 No. 250.0.

**Chicago Plenum:** City of Chicago Approved (CCEA) when specified with CP option.

**IC rated:** Suitable for direct contact with insulation

**Declare:** [LBC Red List Approved](#)

## **WARRANTY**

Lumenwerx provides a five-year limited warranty on electrical and mechanical performance of the luminaires, including the LED boards, drivers, and auxiliary electronics. Lumenwerx will repair or replace defective luminaires or components at our discretion, provided they have been installed and operated in accordance with our specifications. Other limitations apply, please refer to the full warranty on our website.

Wall controllers are covered by the manufacturer warranty.

# VIA 2 PERIMETER

RECESSED PATTERN  
CHROMAWERX - SOLA, DUO



## DUO DMX SPECIFICATION

A qualified DMX integrator is required to assure proper installation and commissioning of the DMX network. **When placing the PO, please provide the contact information of your DMX integrator.**

Please answer the following questions to help us identify your DMX network requirements.

YES

Do you require a wall controller provided by Lumenwerx?

NO

DMX control system supplied by others. Lumenwerx will supply DMX-enabled fixtures with default DMX addressing. See following pages for technical DMX informations. ✓

DMX controller supplied by Lumenwerx

**How many zones do you have?**  
A zone consists of one or more luminaires behaving identically.

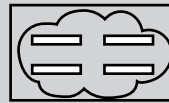

1 Zone



2 Zones

**How to calculate the required number of drivers:**

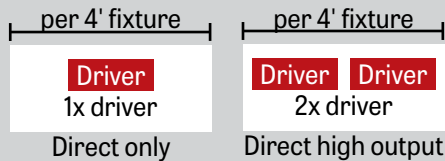

To Calculate # of drivers

NO

YES

Do you have more than 32 drivers in total?

Order a standard Lumenwerx wall controller.

### WALL CONTROLLER

**WCW** - wall controller white  
**WCB** - wall controller black

Add the control code at the end of your order code.

Please provide a fixture layout or RCP (Reflected Ceiling Plan) showing the locations of the DMX fixtures, zones and the DMX wall controller.

Refer to your DMX integrator for the installation. ✓

Subject to factory evaluation. Please contact our controls specialist at [controls@lumenwerx.com](mailto:controls@lumenwerx.com). Additional cost and equipment will be required. ✓

Subject to factory evaluation and approval. Please contact our controls specialist at [controls@lumenwerx.com](mailto:controls@lumenwerx.com). Additional cost and equipment will be required. ✓

# VIA 2 PERIMETER

RECESSED PATTERN  
CHROMAWERX - SOLA, DUO



## GENERIC DMX NETWORK ARCHITECTURE

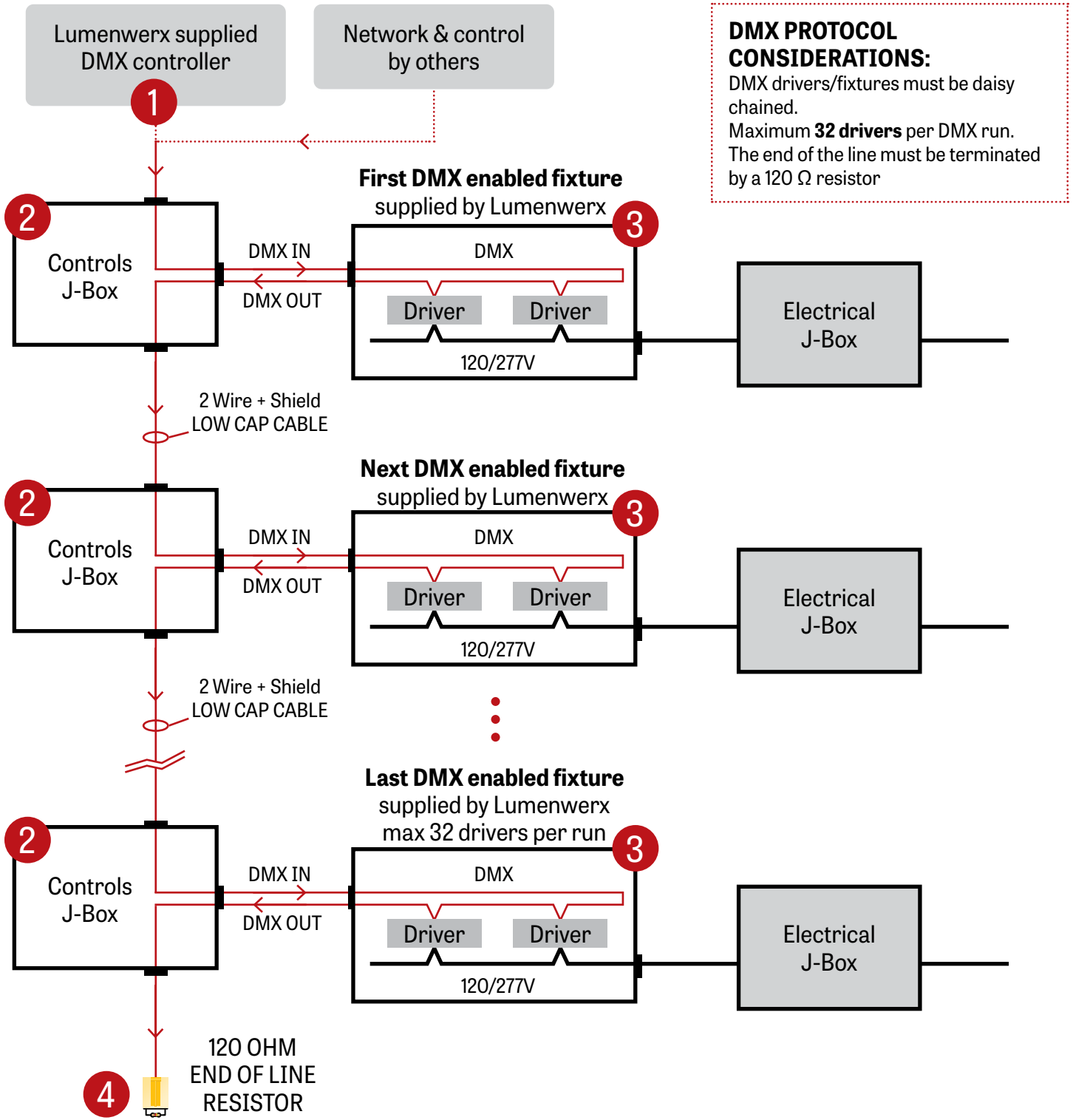

# VIA 2 PERIMETER

RECESSED PATTERN  
CHROMAWERX - SOLA, DUO



## 1 LUMENWERX SUPPLIED DMX CONTROLLER

To the first fixture

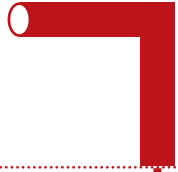

2 Wire +  
Shield Low Cap Cable

WALL BOX SUPPLIED BY OTHERS

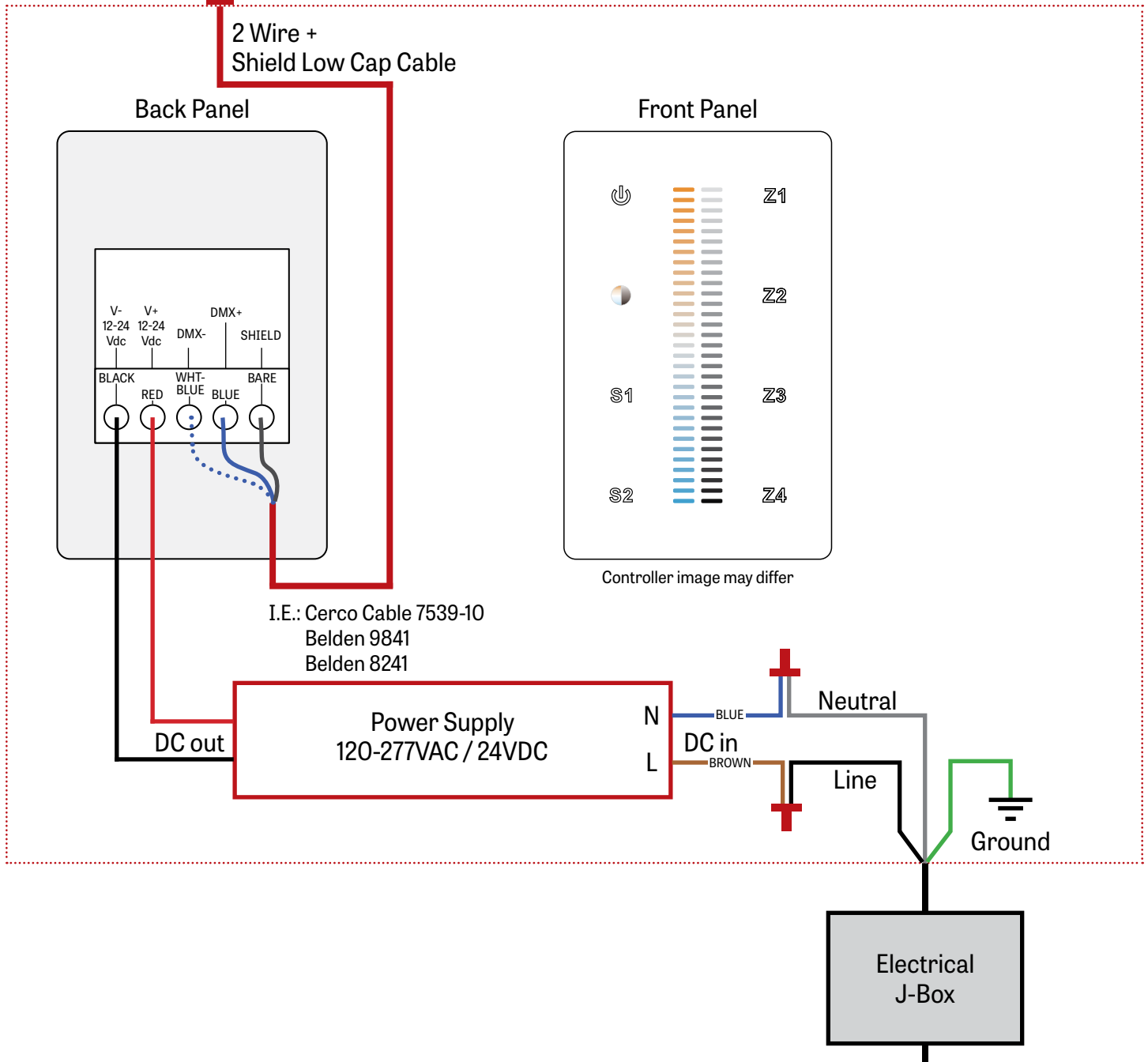

# VIA 2 PERIMETER

RECESSED PATTERN  
CHROMAWERX - SOLA, DUO

## 2 J-BOX DMX DAISY CHAIN DETAIL

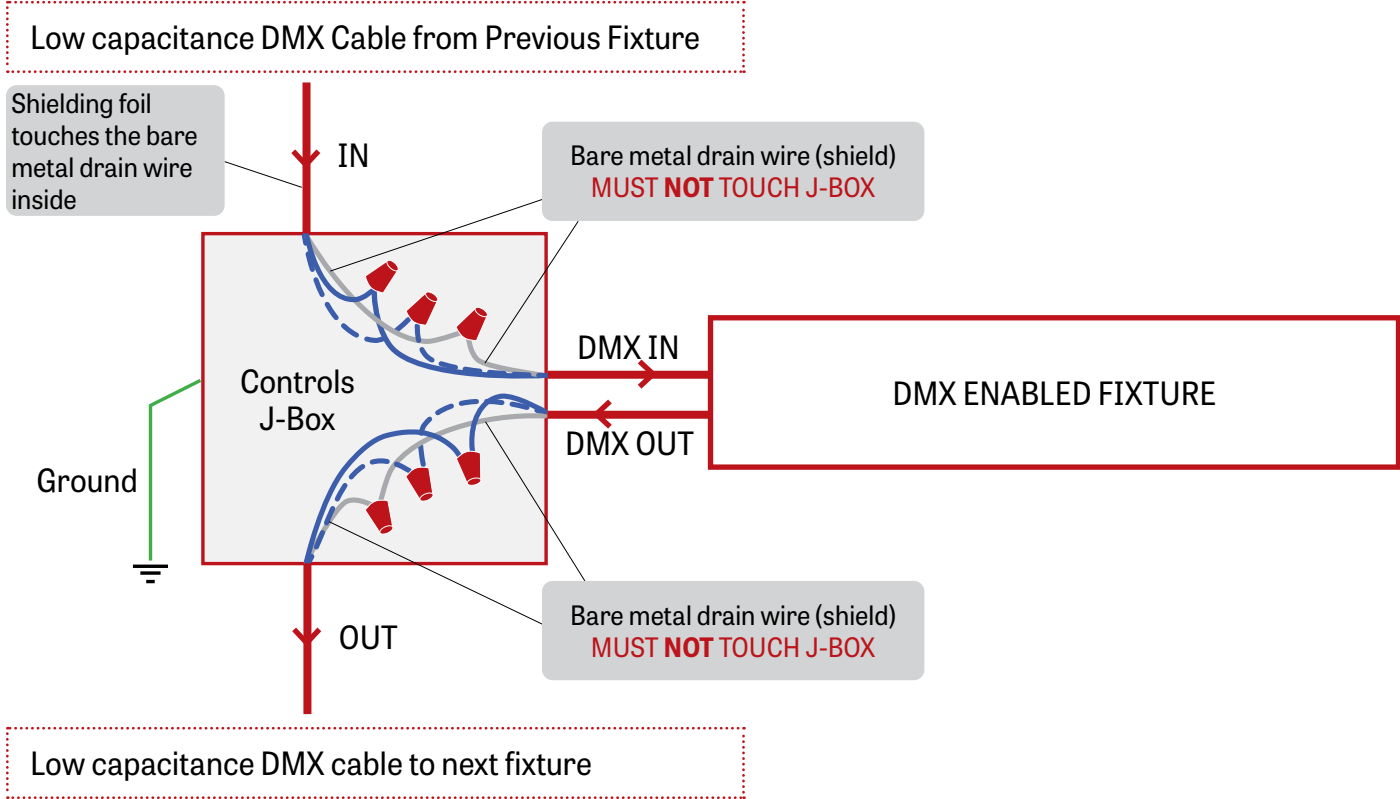

## 3 DMX CONNECTION RECESSED & SURFACE

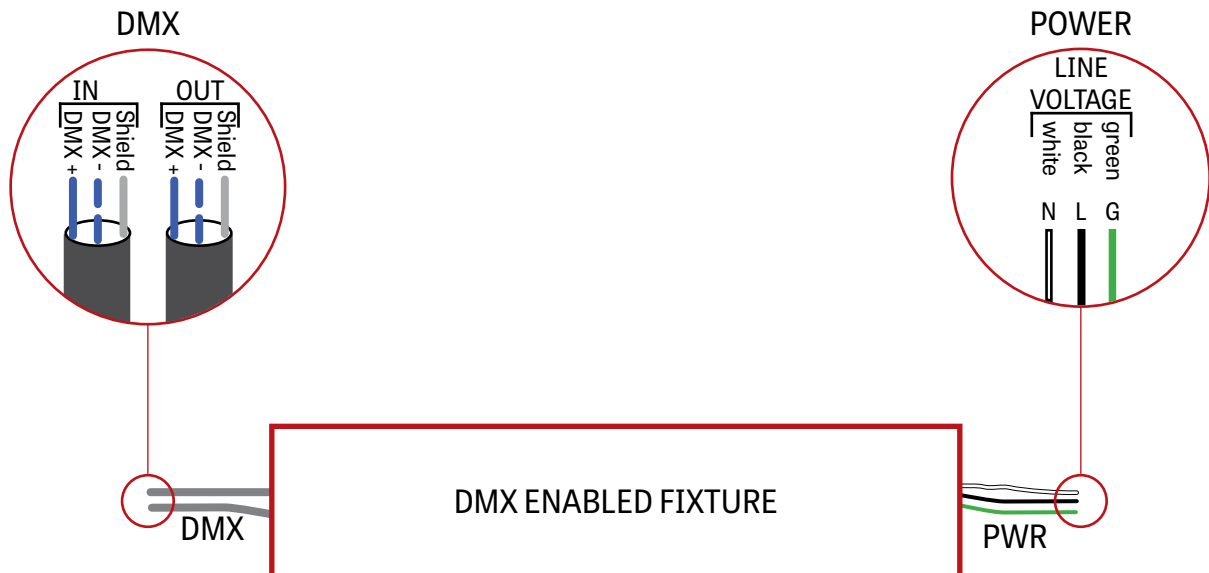

# VIA 2 PERIMETER

RECESSED PATTERN  
CHROMAWERX - SOLA, DUO



## 4 DMX LAST FIXTURE DETAIL

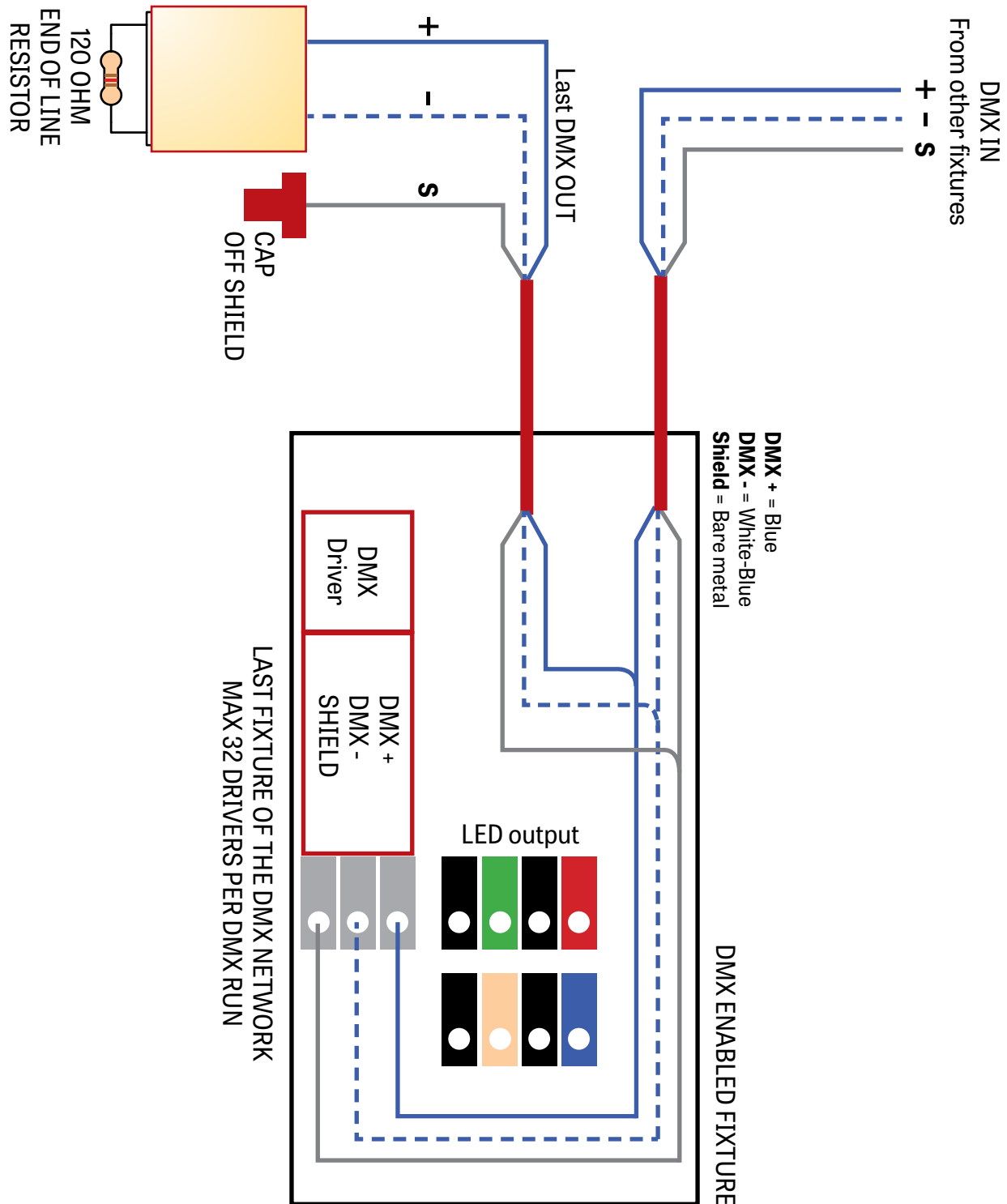

# VIA 2 PERIMETER

RECESSED PATTERN  
CHROMAWERX - SOLA, DUO



## DMX WALL CONTROLLER

### DUO 1-4 ZONE

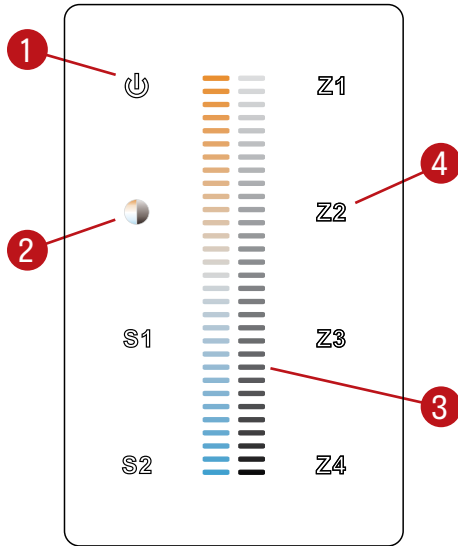

- (1) Power: Use this button to turn ON or OFF the fixture.
- (2) Brightness/CCT: Use the color/brightness toggle button to choose between color/brightness. When Blue: brightness is selected, when Yellow: color is selected.
- (3) Slider: Depending on the mode chosen in step 2, the slider will allow the user to set desired color or brightness.
- (4) Zone select: Up to 4 zones can be selected either independently or together. Once selected, the commands will be sent to the zone identified by a Blue LED.

### Default DMX Addresses:

- 1 Warm
- 2 Cool

# VIA 2 PERIMETER

RECESSED PATTERN  
CHROMAWERX - SOLA, DUO



## DUAL 0-10V WALL CONTROLLER

### Front Panel

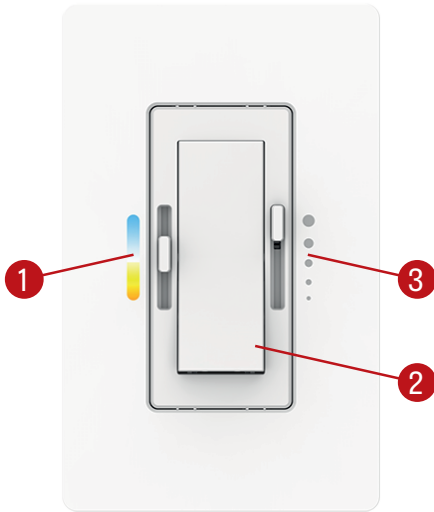

Controller image may differ

### Dimensions

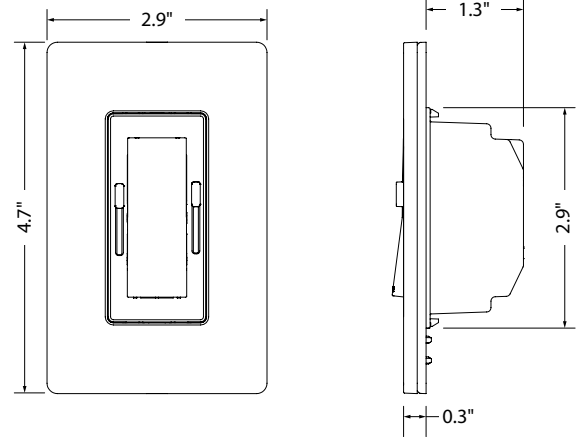

- (1) CCT control: Use this button to adjust the color temperature.
- (2) On/Off switch: Use this button to turn ON or OFF the fixture.
- (3) Dimming control: Use this button to adjust the brightness.

### Wiring Diagram

