

# VIA 2 PRISM

COMBINATION PENDANT PATTERN  
DIRECT/INDIRECT, DIRECT



Equipped with all of the features that have made Via among our most successful product lines, the Via 2 Prism pushes the technological envelope even further with its Diamond Prism Optic™ (DPO™), a sophisticated louver engineered to deliver soft, glare-free illumination that wraps around subjects casting gradients of light rather than dramatic sharp-edged shadows.

Via 2 Prism Combination Pattern luminaires are composed of luminaires joined together to create patterns within which a combination of optics (either DPO™ and/or HLO and/or blanks) is used.

## DIAMOND PRISM OPTIC

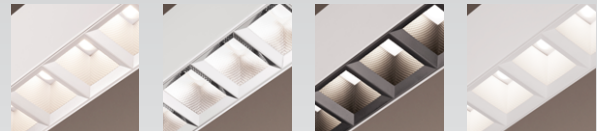

MATTE SILVER

PRECISION SPECULAR

MATTE BLACK

MATTE WHITE

## CORNER

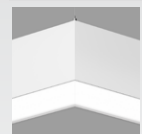

LEVELED

DIAMOND PRISM OPTIC + BLANK + HLO

**SENSORS**  
For latest information on sensors, click [here](#).

# VIA 2 PRISM

COMBINATION PENDANT PATTERN  
DIRECT/INDIRECT, DIRECT



Project: \_\_\_\_\_

Type: \_\_\_\_\_

## Order Guide

A drawing of your pattern is required - anything from a line drawing to an architectural drawing.

| LUMINAIRE ID  | DISTRIB.   | TOTAL PATTERN LENGTH <sup>1</sup>  | DIRECT OPTICS <sup>3</sup><br>Specify the total length for each required optic, including the corner lengths   | INDIRECT OPTIC <sup>4</sup><br>Specify NA for Direct fixture   | LIGHT SOURCE <sup>5</sup>  |
|---|--|--|--|--|--|
| <b>VIA2PRCOMPAT</b>   |  |  |  |  |  |
| <b>VIA2PRCOMPAT</b><br>- Via 2" Prism<br>Combination Pendant<br>Pattern | <b>DI</b> -<br>Direct/<br>Indirect<br><b>D</b> -<br>Direct | <b>##FT##IN(##X##FT##IN-<br/>##X##FT##IN...)</b> <sup>2</sup> -<br><br>##FT##IN: total nominal length<br>of pattern in feet and/or inches<br>#X: quantity of each section<br>#FT##IN: nominal length of each<br>section in feet and/or inches<br><br>Continuous runs: lengths over 12' | <b>SDPO</b> - Matte Silver Diamond Prism Optic<br><b>FT</b><br><b>PDPO</b> - Precision Specular Diamond Prism<br>Optic<br><b>FT</b><br><b>BDPO</b> - Matte Black Diamond Prism Optic<br><b>FT</b><br><b>WDPO</b> - Matte White Diamond Prism Optic<br><b>FT</b><br><b>HLO</b> - High-Efficiency Lambertian Optic<br><b>FT</b><br><b>BLA</b> - Blank<br><b>FT</b> | <b>WIO2</b> - Widespread<br>Indirect Optic<br><b>TIO</b> - Translucent<br>Indirect Optic<br><b>WAI2</b> - Widespread<br>Asymmetric Indirect<br>Optic<br><b>NA</b> - Not applicable | <b>SW</b> - Static<br>white<br><b>FS</b> - Full<br>spectrum<br>static<br>white<br><br><sup>5</sup> Chromawerx<br>SOLA and<br>DUO also<br>available.<br>Consult<br>factory. |

Ex: SDPO5FT-BDPO2FT-HLO12FT3IN

<sup>1</sup>Total pattern length should equal the sum of all the direct optic lengths.  
<sup>2</sup>Minimum 2' for Direct, minimum 3' for Direct/Indirect.

<sup>3</sup>DPO louvers are only available in 1' and/or 6" sections.  
HLO and Blank are available in 1' and/or 1" sections.

<sup>4</sup>The indirect distribution is always fully lit.

| CRI   | DIRECT LUMEN PACKAGE   | INDIRECT LUMEN PACKAGE<br>Specify NA for Direct fixture   | COLOR TEMP.  | CORNER TYPE <sup>19</sup>   |
|---|--|---|--|---|
| <b>80CRI</b> <sup>6</sup> - 80+<br>CRI<br><b>90CRI</b> <sup>6</sup> - 90+<br>CRI<br><b>95CRI</b> <sup>7</sup> - 95+ CRI | <b>350LMF</b> <sup>8</sup> - Low output 350 lm/ft<br><b>500LMF</b> <sup>9</sup> - Medium output 500 lm/ft<br><b>750LMF</b> <sup>10</sup> - High output 750 lm/ft<br><b>1000LMF</b> <sup>11,12,13,14</sup> - Ultra high output 1000 lm/ft<br><b>1200LMF</b> <sup>12,13,14,15,16</sup> - Hyper output 1200 lm/ft | <b>350LMF</b> <sup>8</sup> - Low output 350 lm/ft<br><b>500LMF</b> - Medium output 500 lm/ft<br><b>750LMF</b> - High output 750 lm/ft<br><b>1000LMF</b> <sup>14,17</sup> - Ultra high output 1000 lm/ft<br><b>1200LMF</b> <sup>14,17,18</sup> - Hyper output 1200 lm/ft<br><b>NA</b> - Not applicable | <b>27K</b> - 2700K<br><b>30K</b> - 3000K<br><b>35K</b> - 3500K<br><b>40K</b> - 4000K<br><b>50K</b> - 5000K | <b>#LEV2C(A##XX)</b><br>- 2-way leveled<br>corner<br><br><b>ANGLE (A##)</b><br><b>(A90)</b> - 90°<br><b>(A##)</b> <sup>20</sup> -<br>Custom<br><br><b>OPTIC (XX):</b><br><b>HLO</b> - High-<br>Efficiency<br>Lambertian Optic<br>corner min. 2'x2'<br><b>BLA</b> - Blank corner<br>min. 6"x6" |

<sup>6</sup>Not available with full spectrum.  
<sup>7</sup>Not available with static white.

<sup>8</sup>Minimum 4' with ELV/TRI driver options.  
<sup>9</sup>For BDPO, Indirect must not exceed 1000 lm/ft.  
<sup>10</sup>For BDPO, Indirect must not exceed 500 lm/ft.  
<sup>11</sup>For PDPO/SDPO/WDPO, Indirect must not exceed 1000 lm/ft.  
<sup>12</sup>Not available with BDPO.  
<sup>13</sup>For HLO, Indirect must not exceed 500 lm/ft.  
<sup>14</sup>Not available with full spectrum.

<sup>15</sup>For PDPO/SDPO/WDPO, Indirect must not exceed 750 lm/ft.  
<sup>16</sup>For HLO, fixture will be very bright. Use in suitable applications.  
<sup>17</sup>Not available with WAI2.  
<sup>18</sup>Fixture will be very bright. Use in suitable applications.

<sup>19</sup>Specify quantity (#), angle (A##), and optic(XX) for each required corner type. Separate corner types with a "+" if more than one is required, e.g. 1LEV2C(A90HLO)+2LEV2C(A90BLA).  
<sup>20</sup>Minimum angle is 30°.

| VOLTAGE  | DRIVER <sup>22</sup>  | ELECTRICAL  | ELECTRICAL SECTIONS (optional) <sup>29,30</sup>   |
|--|---|---|---|
| <b>120V</b> - 120V<br><b>277V</b> - 277V<br><b>UNV</b> - 120V-277V<br><b>347V</b> <sup>21</sup> - 347V | <b>D1</b> - 1% 0-10V<br><b>ELV</b> <sup>23</sup> - ELV 120V<br><b>TRI</b> <sup>23</sup> - TRIAC 120V<br><b>DA</b> <sup>24</sup> - DALI<br><b>LDEI</b> <sup>24</sup> - Lutron Hi-lume 1% Eco<br><b>ELDI</b> - eldoLED 1% ECOdrive 0-10V<br><b>ELDO</b> - eldoLED 0.1% SOLOdrive 0-10V<br><br><sup>22</sup> PoE (Power-over-Ethernet) compatible. Consult factory for details.<br><sup>23</sup> Available with 120V only.<br><sup>24</sup> On-site commissioning is required. | <b>1C</b> - 1 circuit<br><b>2C</b> <sup>25</sup> - 2 circuits<br><b>#MC</b> <sup>26</sup> - Multi circuit<br><b>EC</b> - Emergency-powered fixture<br><b>NL</b> - Night light fixture<br><b>DL</b> - Daylight fixture<br><b>GTD</b> <sup>27,28</sup> - Generator transfer device fixture<br><br><sup>25</sup> Available for Direct/Indirect only. Separate direct and indirect circuits.<br><sup>26</sup> Specify total number of circuits (#), including any required for electrical section options. Provide drawing or layout specifications. Minimum 4' section per circuit.<br><sup>27</sup> Minimum 4' fixture.<br><sup>28</sup> Not available with 347V. | <b>#EC##</b> <sup>31</sup> - Emergency-powered section<br><b>#NL##</b> <sup>31</sup> - Night light section<br><b>#DL##</b> <sup>31</sup> - Daylight section<br><b>#GTD##</b> <sup>31,32,33</sup> - Generator transfer device section<br><b>#EMB</b> <sup>33,34</sup> - Emergency battery<br><b>NA</b> - None<br><br><sup>29</sup> Specify with multi circuit (#MC) electrical option only.<br><sup>30</sup> Provide drawing or layout specifications. Consult factory for other configurations. Default section length is 4'.<br><sup>31</sup> Specify quantity (#), and section length in inches (##).<br><sup>32</sup> Minimum 4' section.<br><sup>33</sup> Not available with 347V.<br><sup>34</sup> Specify quantity (#). All batteries will be on the same circuit. Each battery powers a 4' section. For Direct/Indirect, minimum 8' fixture. |

| MOUNTING <sup>35</sup>  | FINISH <sup>36</sup>  | CONTROL <sup>37</sup>  | OPTIONS <sup>43</sup>   |
|---|---|--|---|
| <b>ACS</b> - Aircraft cable, standard<br><b>STS</b> - Stem, standard<br><b>ACC()</b> - Aircraft cable, custom<br><b>STC()</b> - Stem, custom<br><br><sup>35</sup> Standard canopies are black for black fixtures, and white for all other finishes. See page 3 for full details on standard and custom options. | <b>W</b> - Matte white<br><b>AL</b> - Aluminum<br><b>B</b> - Matte black<br><b>CF#</b> - Custom finish, specify RAL#<br><br><sup>36</sup> Blanks will match the fixture color unless otherwise specified. | <b>STANDALONE CONTROLS</b> <sup>38,39</sup><br>Specify the quantity (#) of sensors per fixture.<br><b>#OMS</b> <sup>40</sup> - Onboard Occupancy<br><b>#OMS##</b> <sup>41</sup> - Onboard Occupancy with bi-level dimming<br><b>#ODS</b> - Onboard Daylight<br><b>#OCS</b> - Onboard Occupancy & Daylight<br><br><b>CONNECTED CONTROLS</b> <sup>42</sup><br><b>LU</b> - Lutron<br><b>AWNR</b> - Lutron Athena Wireless Node RF Only<br><b>AWNS</b> - Lutron Athena Wireless Node Sensor<br><b>ENC</b> - Encelium<br><b>WL</b> - Cooper Wavelinx<br><b>AN</b> - Acuity nLight<br><b>CA</b> - C asambi<br><b>LG</b> - Legrand<br><br><b>NA</b> - None<br><br><sup>37</sup> Standalone and connected control options cannot be combined.<br><sup>38</sup> Available with D1 driver and 1 circuit options only.<br><sup>39</sup> Minimum 4' per zone. Provide control zone length.<br><br><sup>40</sup> Fixture turns off when no occupancy.<br><sup>41</sup> Fixture dims to specified light level % (##).<br><sup>42</sup> Consult factory for connected controls. | <b>FU120</b> - Fuse 120V<br><b>FU277</b> - Fuse 277V<br><b>CTB9</b> <sup>44</sup> - T-bar caddy clip, 9/16"<br><b>CTB15</b> <sup>44</sup> - T-bar caddy clip, 15/16"<br><b>CTC9</b> <sup>44</sup> - Tegular caddy clip, 9/16"<br><b>CTG15</b> <sup>44</sup> - Tegular caddy clip, 15/16"<br><b>CST</b> <sup>44</sup> - Screw slots T-bar<br><b>NA</b> - None<br><br><sup>43</sup> Separate codes with a "+" if more than one is specified.<br><sup>44</sup> Available with aircraft cable only. |



# VIA 2 PRISM

COMBINATION PENDANT PATTERN  
DIRECT/INDIRECT, DIRECT



## Pendant Mounting Code

### Aircraft Cable

#### Standard

##### ACS - Aircraft cable, standard

- Ø 5" for power canopy
- Ø 3" for non-power canopy
- Canopies are black for black fixtures, and white for all other fixture finishes
- Power cord is black for black fixtures, and white for all other fixture finishes
- Aircraft cable length is 36"

#### Custom

Example: ACC(3NPC-72IN-W-PCB-NA)

| ACC()  |   |  |  |  |
|--|---|--|--|--|
| NON-POWER CANOPY SIZE  | AIRCRAFT CABLE LENGTH   | CANOPY FINISH  | POWER CORD COLOR                         | OPTION   |
| <b>3NPC</b> - Ø 3" non-power canopy<br><b>5NPC</b> - Ø 5" non-power canopy | <b>36IN</b> - 36"<br><b>72IN</b> - 72"<br><b>120IN</b> - 120"<br><b>#IN</b> <sup>1</sup> - Other lengths, specify in inches<br><br><small><sup>1</sup>Maximum length is 288". For longer lengths, please consult factory.</small> | <b>W</b> - White<br><b>AL</b> - Aluminum<br><b>B</b> - Black<br><b>CF#</b> - Custom finish, specify RAL# | <b>PCW</b> - White<br><b>PCB</b> - Black | <b>SEM</b> <sup>2</sup> - Seismic mounting<br><b>SLC</b> <sup>2</sup> - Sloped ceiling for aircraft cable<br><b>NA</b> - None<br><br><small><sup>2</sup>Not available with the Ø 3" non-power canopy size.</small> |

### Stem

#### Standard

##### STS - Stem, standard

- Ø 5" for power canopy
- Ø 5" for non-power canopy
- Canopies are black for black fixtures, and white for all other fixture finishes
- Stem finish is the same color as fixture
- Stem length is 18"
- Stem is not field adjustable

#### Custom

Example: STC(5NPC-36IN-W-STW-SLS)

| STC()                               |   |  |  |  |
|-------------------------------------|---|--|--|--|
| NON-POWER CANOPY SIZE               | STEM LENGTH   | CANOPY FINISH  | STEM COLOR   | OPTION   |
| <b>5NPC</b> - Ø 5" non-power canopy | <b>18IN</b> - 18"<br><b>36IN</b> - 36"<br><b>#IN</b> <sup>3</sup> - Specify length in inches<br><br><small><sup>3</sup>Minimum length is 6". Maximum length is 72". Stem is not field adjustable.</small> | <b>W</b> - White<br><b>AL</b> - Aluminum<br><b>B</b> - Black<br><b>CF#</b> - Custom finish, specify RAL# | <b>STW</b> - White<br><b>STAL</b> - Aluminum<br><b>STB</b> - Black<br><b>STCF#</b> - Custom finish, specify RAL# | <b>SLS</b> - Sloped ceiling for stem<br><b>NA</b> - None |

## Dimensions

DIRECT/INDIRECT

DIRECT

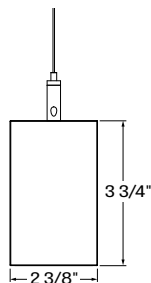
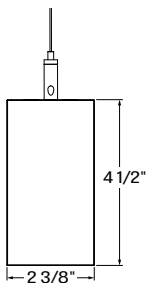

# VIA 2 PRISM

COMBINATION PENDANT PATTERN  
DIRECT/INDIRECT, DIRECT



## Pattern Layout

CORNER TYPE

### LEVELED CORNER

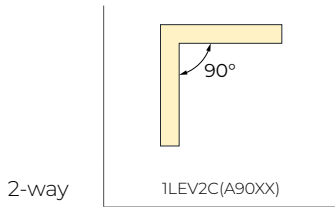

EXAMPLES

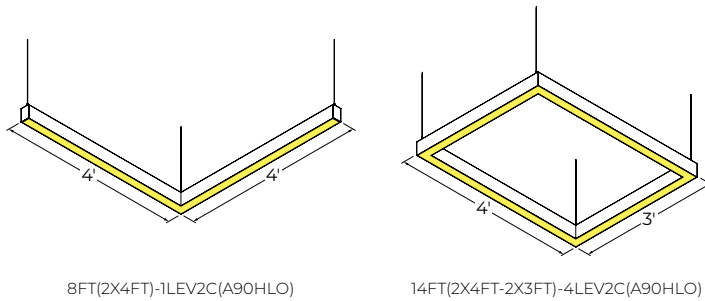

A drawing of your Via 2 Prism Combination Pattern is required - anything from a line drawing to an architectural drawing. Louvers are available in 1' and/or 6" sections. HLO and Blank are available in 1' and/or 1" sections.

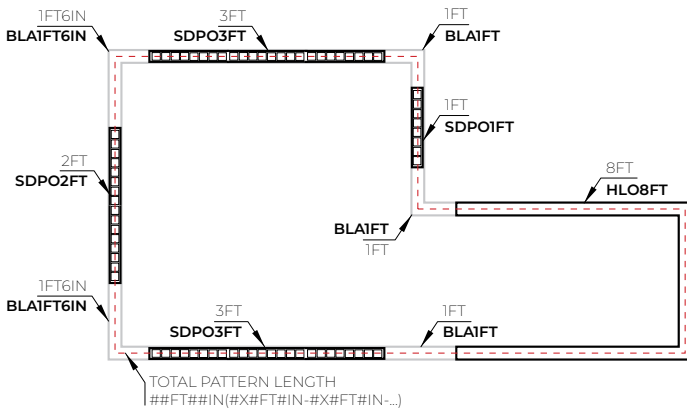

Ex.: TOTAL PATTERN LENGTH: **23FT(1X4FT-1X2FT-1X3FT6IN-1X2FT-1X7FT6IN-1X4FT)**  
 DIRECT OPTICS: **SDPO9FT-HLO8FT-BLA6FT**  
 CORNER TYPE: **4LEV2C(A90BLA)+2LEV2C(A90HLO)**

# VIA 2 PRISM

COMBINATION PENDANT PATTERN  
DIRECT/INDIRECT, DIRECT



## Photometrics

Values calculated based on a 4' fixture at 3500K and 80+ CRI for all optics.

### DIRECT OPTICS

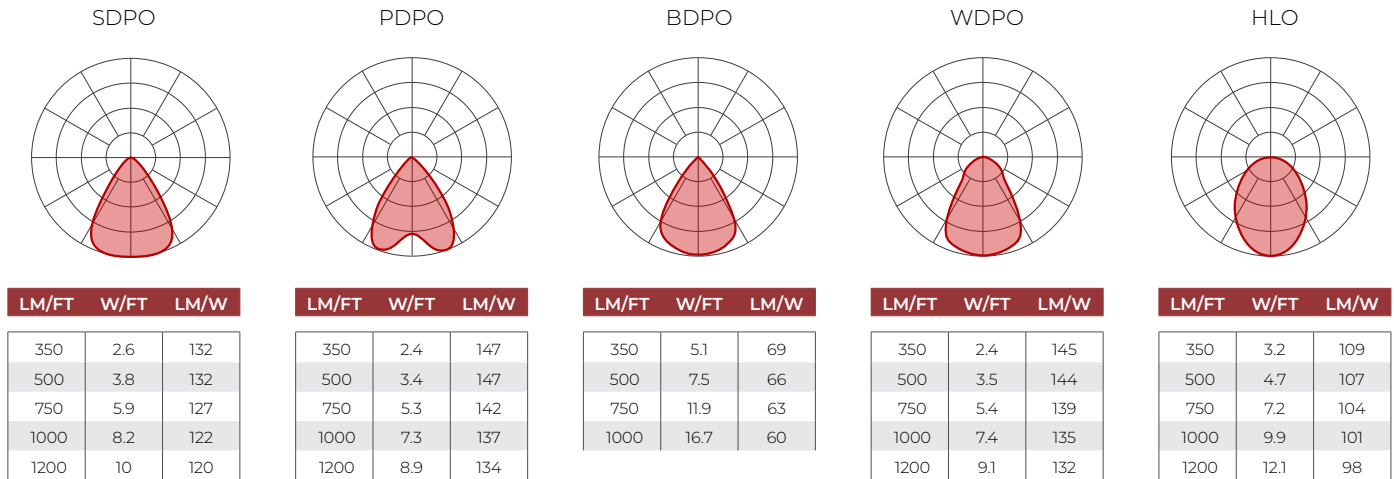

### INDIRECT OPTICS

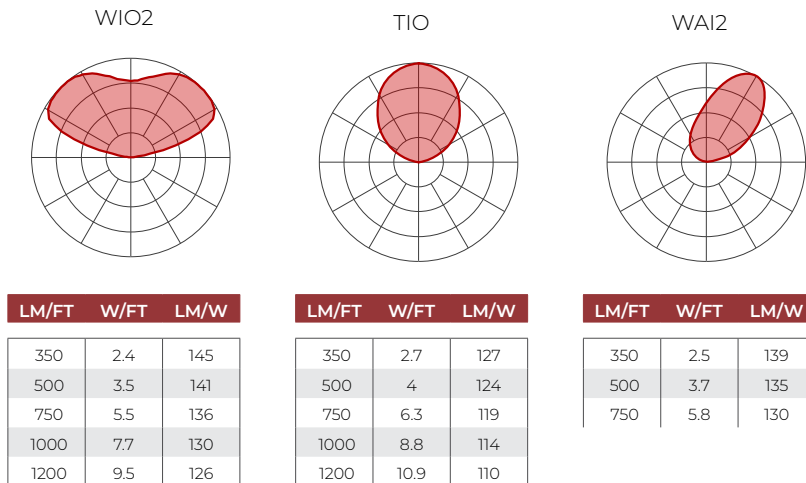

### MULTIPLIER TABLES

Use these tables to get results for different color temperatures and CRI for all Direct and Indirect photometric tables.

#### Multiplier - CCT/CRI

SDPO, PDPO, BDPO, WDPO

| CCT   | WATTS   |         | LPW     |         |
|-------|---------|---------|---------|---------|
|       | 80+ CRI | 90+ CRI | 80+ CRI | 90+ CRI |
| 2700K | 1.04    | 1.19    | 0.96    | 0.84    |
| 3000K | 1.00    | 1.15    | 1.00    | 0.87    |
| 3500K | 1.00    | 1.12    | 1.00    | 0.89    |
| 4000K | 0.99    | 1.10    | 1.01    | 0.91    |
| 5000K | 0.94    | 1.06    | 1.06    | 0.94    |

#### Multiplier - CCT/CRI

HLO, WIO2, TIO, WAI2

| CCT   | WATTS   |         | LPW     |         |
|-------|---------|---------|---------|---------|
|       | 80+ CRI | 90+ CRI | 80+ CRI | 90+ CRI |
| 2700K | 1.05    | 1.27    | 0.95    | 0.79    |
| 3000K | 1.02    | 1.23    | 0.98    | 0.81    |
| 3500K | 1.00    | 1.19    | 1.00    | 0.84    |
| 4000K | 1.00    | 1.19    | 1.00    | 0.84    |
| 5000K | 0.96    | 1.12    | 1.04    | 0.89    |

### DIRECT/INDIRECT - LPW CALCULATION

For Direct/Indirect performance values, follow the formula.

$$\left( \frac{\text{DIRECT LM/FT} + \text{INDIRECT LM/FT}}{\text{DIRECT W/FT} + \text{INDIRECT W/FT}} \right) = \text{LPW}$$



# VIA 2 PRISM

COMBINATION PENDANT PATTERN  
DIRECT/INDIRECT, DIRECT



## Technical Specifications

### DIRECT OPTICS

#### Diamond Prism Optic (DPO)

The Diamond Prism Optic™ (DPO™) is our patent-pending 3-tiered optic meticulously crafted to refract and reflect beams with great precision, effectively keeping glare to a minimum while delivering light of exceptional quality and visual comfort.



MATTE SILVER

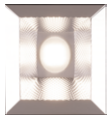

PRECISION SPECULAR

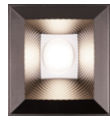

MATTE BLACK



MATTE WHITE

#### UGR - Diamond Prism Optic

| LM/FT | MATTE SILVER | PRECISION SPECULAR | MATTE BLACK | MATTE WHITE |
|-------|--------------|--------------------|-------------|-------------|
| 350   | 9.7          | 1.2                | 1.2         | 14.9        |
| 500   | 10.9         | 2.4                | 2.4         | 16.1        |
| 750   | 12.3         | 3.8                | 3.8         | 17.8        |
| 1000  | 13.3         | 4.8                | N/A         | 18.8        |
| 1200  | 13.9         | 5.4                | N/A         | 19.2        |

#### High-Efficiency Lambertian Optic (HLO)

The High-Efficiency Lambertian Optic (HLO) uses matte white reflectors to distribute LED output across 0.075" acrylic shielding, providing up to 88% transmission and good obscuration. Available as a flush lens or as a drop lens, the HLO has a spacing criterion of 1.06.

#### Blank (BLA)

Blank covers provide spacing – functional or rhythmic – in the direct component of the luminaire. Covers are sized according to the Combination design, finished to match the luminaire housing, and snap into the aperture.

### INDIRECT OPTICS

#### Widespread Indirect Optic (WIO2)

The Widespread Indirect Optic (WIO2) is a horizontal LED array with a widespread indirect micro prismatic optic that offers an impressive 160° spread. WIO2 creates an even illumination for smooth brightness on the ceiling that can achieve uniformity ratios of up to 2:1.

#### Uniformity [max/min]

Based on 18' continuous runs, in a 20' x 40' room, 10' wall height

| Mounting height from ceiling | Spacing (Center to center) |      |     |
|------------------------------|----------------------------|------|-----|
|                              | 8'                         | 10'  | 12' |
| 12"                          | 5.5                        | 10.0 | 9.0 |
| 18"                          | 3.5                        | 6.0  | 6.0 |
| 24"                          | 2.5                        | 4.0  | 4.5 |

#### Translucent Indirect Optic (TIO)

The Translucent Indirect Optic (TIO) is composed of a horizontal LED array that has a translucent lens to mask pixilation from the diodes. TIO has a 100° spread in the indirect that is ideal when the fixture is mounted farther away from the ceiling.

#### Widespread Asymmetric Indirect Optic (WAI2)

The Widespread Asymmetric Indirect Optic (WAI2) offers an upward grazing effect with a 45° forward throw. It softly highlights the ceiling in the up-light while distributing the required illumination of the rest of an interior space. For avoiding glare and enjoying visual comfort, WAI2 is an ideal solution.

### LIGHT SOURCE

#### Static white

Custom linear array of mid-flux LEDs are cartridge-mounted with quick-connect wiring to facilitate service and thermal management. Available in 2700K, 3000K, 3500K, 4000K, and 5000K with a minimum 80+ CRI and an option for 90+ CRI with elevated R9 value. Color consistency maintained to within 3 SDCM. LEDs operate at reduced drive current to optimize efficacy and lumen maintenance. All LEDs have been tested in accordance with IESNA LM-80-08 and the results have shown L80 lumen maintenance greater than 60,000 hours. Absolute product photometry is measured and presented in accordance with IESNA LM-79, unless otherwise indicated.

#### Full spectrum static white

The full spectrum LED option offers improved color particularly in the cyan region that is beneficial in both healthcare and circadian lighting strategies. The cyan region in full spectrum LED is richer at the 480 nm range.

# VIA 2 PRISM

COMBINATION PENDANT PATTERN  
DIRECT/INDIRECT, DIRECT



## PATTERN LENGTH

All individual sections are joined together onsite using the joiner kits provided. Lumenwerx offers joiner kits that are extremely simple to work with in the field and result in a fixture that appears virtually seamless with no light leak at any connection.

## ELECTRICAL

Factory-set, adjustable output current LED driver with universal (120-277 VAC) input. Dimmable from 100% to 1% with 0-10V dimming control. Rated life (90% survivorship) of 50,000 hours at 50°C max. ambient (and 70°C max. case) temperature. At maximum driver load: Efficiency > 84%, PF > 0.9, THD < 20%. Other specifiable options include Lutron Hi-Lume 1% Eco, eidoLED 1% ECOdrive 0-10V, eidoLED 0.1% SOLOdrive 0-10V, ELV, TRIAC, and DALI protocol drivers. All of our standard 0-10V drivers are NEMA 410 compliant.

## PoE

Depending on the PoE manufacturer selected, Lumenwerx will install the node in factory as either integral to the luminaire or as a remote module. Factory programming of the PoE node may or may not enable the following functionalities: lumen package, DUO (tunable white), QUADRO (RGBW), emergency battery backup, and sensor integration. These must be addressed and evaluated on a case-by-case basis.

## ELECTRICAL SECTION OPTIONS

Electrical section options are available for fixtures specified as multi circuit (#MC). With MC, specify the total number of circuits (#), including any circuits required for optional electrical sections. A drawing is required to specify the layout. Please consult factory for custom configurations.

## Electrical sections

Options include emergency-powered (#EC##), night light (#NL##), daylight (#DL##), and generator transfer device (#GTD##) sections. Specify the quantity (#), as well as the section length in inches (##).

Example 1: A 32' Direct fixture with two 8' emergency-powered sections on a second circuit.  
Code: 2MC-2EC96

Example 2: A 16' Direct/Indirect fixture with separate circuits for direct and indirect, and with one 4' night light section on the direct side on a third circuit.  
Code: 3MC-1NL48

Example 3: A 24' Direct fixture with one 4' generator transfer device section.  
Code: 1MC-1GTD48

## Battery

Each emergency battery (#EMB) powers a 4' section. All batteries will be on the same circuit. Specify the number of batteries (#) required.

Factory installed long life, high temperature, maintenance-free Lithium-Ion battery pack with self-test functionality, test switch and charge indicator. Minimum of 90 minutes operation, up to 1000 lumens per 4' (25°C) emergency lighting output and recharge time of 24 hours.

## MOUNTING

Pendant fixtures can be mounted either with aircraft cable or with stem. See page 3 for details.

## FINISH

**Interior:** 95%, reflective matte powder coated white paint

**Exterior:** Matte white, matte black, or aluminum powder coating. Custom finishes are also available.

## CONTROLS

Lumenwerx offers several options for integrating occupancy and daylight harvesting controls in our luminaires.

For latest information on sensors, click [here](#).



## Standalone controls

An integrated standalone sensor controls the luminaire in which it is installed. Depending on the length, more than one sensor may be necessary and may control the entire luminaire, or just a section of it. These controls operate independently. Unless otherwise agreed, sensor location, blank size, and functionality of the sensor within the luminaire are selected by Lumenwerx. See client drawings for details.

Three types are available:

OMS: An integral Passive InfraRed (PIR) sensor turns luminaires on and off automatically with field-adjustable time out period. No wall control is used. Coverage pattern for large motion has a 12' diameter with the sensor mounted 8' above the floor; for small motion, the pattern has an 8' diameter. Typically, one sensor is required for every 10' of a continuous luminaire run.

ODS: An integral, daylight harvesting sensor with closed-loop operation dims the luminaire in which it is installed in order to compensate for available daylight. The sensor measures the combination of daylight and luminaire light reflected from horizontal surfaces below the luminaire. Initial onsite calibration is required via the use of provided remote control.

OCS: Both an occupancy and a daylight sensor are installed in the luminaire.

# VIA 2 PRISM

COMBINATION PENDANT PATTERN

DIRECT/INDIRECT, DIRECT



## Connected controls

With connected controls, sensors or nodes installed in the luminaire form part of a larger control system infrastructure from manufacturers such as: Lutron, Encelium, Cooper Wavelinx, Acuity nLight, Casambi, Legrand, and others. These connected controls allow for a scalable system providing features like occupancy and daylight control, manual control, scheduling and configuration of various zones and scenes. Energy reporting and system monitoring are also possible. Specific capabilities depend on the control system being used.

Lumenwerx installs the components (sensors, nodes, power packs, etc) which may be supplied to us by a third party, or procured directly by Lumenwerx, depending on the control system manufacturer.

Lumenwerx is solely responsible for the installation of specified components; the controls manufacturer is responsible for performance of the control system.

To indicate a Lumenwerx luminaire with connected controls, identify the specific onsite control system to be integrated into the luminaires using the ordering code. Due to the diversity of components, you must contact factory to assure complete compatibility with intended control system and to fully specify the luminaire.

Complete control specifications, sensor/node/power pack layout, and narrative for the control system are required for Lumenwerx to create shop drawings and submittals.

## CONSTRUCTION

**Housing:** Extruded aluminum, up to 90% recycled content

**Interior brackets:** Die-formed cold rolled sheet steel

**Joining system:** Die-cast zinc

**Reflectors:** Aluminum or cold rolled steel die-formed, 95% reflective matte white painted

**Lens:** Acrylic or polycarbonate

**Drop lens:** Extruded with glued end caps

**End caps:** Die-cast aluminum

**Hanger:** Chromed griplock securely attached with spring steel hardware in end caps and/or joiners

**Aircraft cable suspension:** 7x7 braids aluminum aircraft cable 0.06" thick

**Stem:** Ø 1/2" threaded steel tube

## WEIGHT

| Direct/Indirect                 | Direct                          |
|---------------------------------|---------------------------------|
| <b>4':</b> 10.68 lbs - 4.85 kg  | <b>4':</b> 9.03 lbs - 4.1 kg    |
| <b>8':</b> 22.03 lbs - 10 kg    | <b>8':</b> 18.28 lbs - 8.3 kg   |
| <b>12':</b> 32.60 lbs - 14.8 kg | <b>12':</b> 27.97 lbs - 12.7 kg |

## CERTIFICATION

**ETL:** Rated for indoor dry/damp locations. Conforms to UL Standard 1598 and certified to CAN/CSA Standard C22.2 No. 250.0.

## WARRANTY

Lumenwerx provides a five-year limited warranty on electrical and mechanical performance of the luminaires, including the LED boards, drivers, and auxiliary electronics. Lumenwerx will repair or replace defective luminaires or components at our discretion, provided they have been installed and operated in accordance with our specifications. Other limitations apply, please refer to the full warranty on our website.