

VIA 2 RECESSED

DIRECT
STATIC WHITE, BIOS



IC RATED Declare.



SENSORS
For latest information on sensors, click [here](#).

Lens Positions

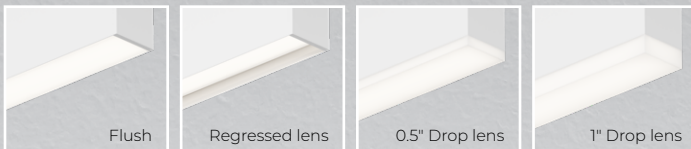

Our elegant, flexible Via family is composed of linear, pendant, surface, recessed, and wall mounted luminaires. Each lighting fixture can be installed as a discrete luminaire or in continuous runs or patterns. Via 2 Recessed is offered with Lambertian, asymmetric, widespread, wall wash, or low-glare optics.

Module Options



DIRECT



VIA 2 RECESSED



DIRECT
STATIC WHITE, BIOS

Project: _____

 Type: _____

Order Guide

LUMINAIRE ID	DISTRIBUTION	OPTIC	LENS POSITION	LIGHT SOURCE ⁵	
VIA2R	D				
VIA2R - Via 2" Recessed	D - Direct	HLO - High-Efficiency Lambertian Optic ARO2 - Asymmetric Refractive Optic WRO2 - Wall Wash Refractive Optic WDO - Widespread Direct Optic LGO - Low-Glare Optic MPO - Micro-Prismatic Optic DDO - Domed Deglare Optic NA ¹ - Not applicable ¹ Specify when only the track option is required. ² See page 3 for ordering details. ³ Consult factory for other track options.	Track option (optional) ^{2,3} +ITRLMX() - Integrated track by Lumenwerx	FH ⁴ - Flush RG ⁴ - Regressed 0.5D ⁴ - 0.5" drop 1.0D ⁴ - 1.0" drop ⁴ For HLO, specify FH, RC, 0.5D, or 1.0D. ⁴ For ARO2, WRO2, WDO, LGO, MPO, and DDO, specify FH.	SW - Static white BIOSST ^{6,7} - BIOS Biological Static BIOSDY ^{6,7} - BIOS Biological Dynamic BIOSTU ^{6,7} - BIOS Biological Tunable ⁵ Chromawerx SOLA, DUO, and QUADRO also available. Consult other spec sheets. ⁶ Only available with low and medium lumen packages. ⁷ See page 8 for details.

CRI	LUMEN PACKAGE	COLOR TEMP.	LUMINAIRE LENGTH	VOLTAGE
80CRI - 80+ CRI 90CRI ⁸ - 90+ CRI ⁸ Not available with BIOS.	200LMF ^{9,10} - Hypo output 200 lm/ft 350LMF - Low output 350 lm/ft 500LMF - Medium output 500 lm/ft 750LMF - High output 750 lm/ft 1000LMF ¹¹ - Ultra high output 1000 lm/ft 1200LMF ^{12,13} - Hyper output 1200 lm/ft NA - Not applicable ⁹ Minimum 4' fixture. ¹⁰ Not available with ELV/TRI driver options. ¹¹ Not available with LGO. ¹² Not available with WDO/LGO/MPO/DDO. ¹³ Fixture will be very bright. Use in suitable applications.	27K ¹⁴ - 2700K 30K - 3000K 35K - 3500K 40K - 4000K 50K ¹⁴ - 5000K ¹⁴ Not available with BIOS.	#FT#IN ¹⁵ - Specify nominal length (#) in 1' and/or 1" increments Standard nominal lengths: Single units: 2' to 12' (up to 8' for MPO and DDO) Continuous runs: lengths over 12' (8' for MPO and DDO) ¹⁵ Available in 2' increments only with BIOSTU/BIOSDY.	120V - 120V 277V - 277V UNV - 120V-277V 347V ¹⁶ - 347V ¹⁶ Available with D1 driver only.

DRIVER ¹⁷	ELECTRICAL	ELECTRICAL SECTIONS (optional) ^{23,24}	MOUNTING ²⁹
D1 - 1% 0-10V DA ¹⁸ - DALI LDE1 ¹⁸ - Lutron Hi-lume 1% Eco ELD1 - eldoLED 1% ECOdrive 0-10V ELDO - eldoLED 0.1% SOLOdrive 0-10V ELV ¹⁹ - ELV 120V TRI ¹⁹ - TRIAC 120V ¹⁷ PoE (Power-over-Ethernet) compatible. Consult factory for details. ¹⁸ On-site commissioning is required. ¹⁹ Available with 120V only.	1C - 1 circuit #MC ²⁰ - Multi circuit EC - Emergency-powered fixture NL - Night light fixture DL - Daylight fixture GTD ^{21,22} - Generator transfer device fixture ²⁰ Specify total number of circuits (#), including any required for electrical section or module options. Provide drawing or layout specifications. Minimum 4' section per circuit. ²¹ Minimum 4' fixture. ²² Not available with 347V.	#EC## ²⁵ - Emergency-powered section #NL## ²⁵ - Night light section #DL## ²⁵ - Daylight section #GTD## ^{25,26,27} - Generator transfer device section #EMB ^{27,28} - Emergency battery NA - None ²³ Specify with multi circuit (#MC) electrical option only. ²⁴ Provide drawing or layout specifications. Consult factory for other configurations. Default section length is 4'. ²⁵ Specify quantity (#), and section length in inches (##). ²⁶ Minimum 4' section. ²⁷ Not available with 347V. ²⁸ Specify quantity (#). All batteries will be on the same circuit. Each battery powers a 4' section.	TG9 - Tegular 9/16" TG15 - Tegular 15/16" TB9 - T-bar 9/16" TB15 - T-bar 15/16" ST - Screw slot T-bar DTR - Trim DTL - Trimless DMF - Drywall mud flange MFM ³⁰ - Multiple flange mounting ²⁹ Transition mounting options also available (e.g. Recessed to Pendant/Surface), consult factory for details. ³⁰ See page 5 for details.

FINISH	CONTROL ^{31,32}	OPTIONS ³⁸	MODULE (optional) ³⁹
W - Matte white B - Matte black CF# - Custom finish, specify RAL#	STANDALONE CONTROLS ^{33,34} Specify the quantity (#) of sensors per fixture. #OMS ³⁵ - Onboard Occupancy #OMS## ³⁶ - Onboard Occupancy with bi-level dimming #ODS - Onboard Daylight #OCS - Onboard Occupancy & Daylight CONNECTED CONTROLS ³⁷ LU - Lutron AWN - Lutron Athena Wireless Node RF Only AWNS - Lutron Athena Wireless Node Sensor ENC - Encelium WL - Cooper Wavelinx AN - Acuity nLight CA - Casambi LG - Legrand NA - None ³¹ Standalone and connected control options cannot be combined. ³² Available with flush lens option only. ³³ Available with D1 driver and 1 circuit options only. ³⁴ Minimum 4' per zone. Provide control zone length.	FU120 - Fuse 120V FU277 - Fuse 277V FWC - Flexible whip cable (6' std) CP - Chicago Plenum NA - None ³⁸ Separate codes with a "+" if more than one is specified.	#DOTIM() - Dot 1.5" #PET1() - Petite 1" Downlight #PETIGLR() - Petite 1" Downlight with glow ring NA - None ³⁹ See page 3 for ordering details. • Not available with track option. • Only available with static white. • Only available with flush lens. • Not available with ELV/TRI driver options. • Not available with EMB. • Consult factory for compatibility with controls.

VIA 2 RECESSED



DIRECT
STATIC WHITE, BIOS

Track Code

Example: +ITRLMX(4FT-GES-BK)

TRACK ^{1,2,3}	TRACK LENGTH	TRACK TYPE ⁴		TRACK FINISH
+ITRLMX() - Integrated track by Lumenwerx ¹ For a track, specify the options in the parentheses. ² Track heads not included. ³ Consult factory for other track options.	#FT#IN - Specify nominal track length (#) in 1" and/or 1" increments	GES - Global single circuit 120V track TEK - Global 2-circuit 120V track HTEK - Global 2-circuit 277V track ⁴ Must specify appropriate fixture voltage. ⁵ Only available with DI, ELD1, and ELD0 driver options.	XTS - Global 3-circuit 120V track (common neutral) XTSC ⁵ - Global 3-circuit 120V track with 0-10V dimming (common neutral)	WH - White BK - Black GR - Gray

Module Code

- For a module, specify the options in the parentheses.
- The light source is static white.
- CRI of module matches specification of main fixture.
- Minimum 4' fixture and minimum 2' section per module. Consult factory for other configurations.

Example: 1DOTIM(4IN-FTMB-SDB-FTMB-20DEG-900LM-27K)

MODULE ^{1,2}	HEIGHT	CYLINDER FINISH	BAFFLE	BAFFLE FINISH	BEAM ANGLE	LUMEN PACKAGE	COLOR TEMP.
#DOTIM() - Dot 1.5" ¹ Specify quantity (#). ² 4" blank per module. Blank finish will match fixture finish.	4IN - 4"	FTMB - Matte black FTMW - Matte white CF# - Custom finish, specify RAL #	SDB - Standard baffle DCB ³ - Decorative baffle ³ Recommended when a different finish is desired for the baffle.	FTMB - Matte black FTMW - Matte white CF# - Custom finish, specify RAL #	20DEG - 20° Spot 35DEG - 35° Narrow flood 50DEG - 50° Wide flood	900LM - 900 lm, 12.2 W 1120LM - 1120 lm, 15.9 W	27K - 2700K 30K - 3000K 35K - 3500K 40K - 4000K

Example: 1PETI(6W-35DEG-27K-SDL-FTMB)

MODULE ^{1,2}	WATTAGE	BEAM ANGLE	COLOR TEMP.	LENS AT BAFFLE	BAFFLE FINISH Specify NA for PETIGLR
#PETI() ³ - Petite 1" Downlight #PETIGLR() - Petite 1" Downlight with glow ring ¹ Specify quantity (#). ² 4" blank per module. Blank finish will match fixture finish. ³ Module is trimless.	6W - 6 W output, up to 472 lm 10W - 10 W output, up to 726 lm	35DEG - 35° Narrow flood 45DEG - 45° Flood	27K - 2700K 30K - 3000K 35K - 3500K 40K - 4000K 50K - 5000K	SDL - Soft diffused lens, solite	FTMB - Matte black FTMW - Matte white FSPC - Satin silver FSSPC - Matte silver FCHP - Champagne FDBZ - Dark bronze CF# - Custom finish, specify RAL# NA - Not applicable

VIA 2 RECESSED



DIRECT
STATIC WHITE, BIOS

Dimensions

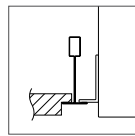
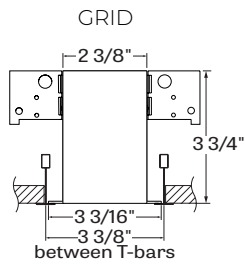
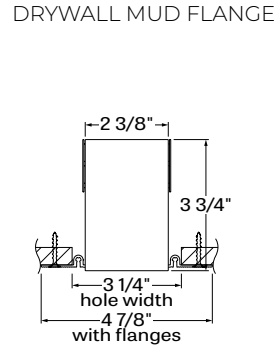
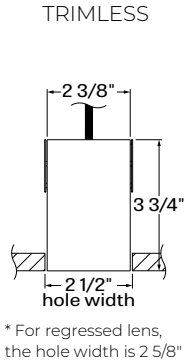
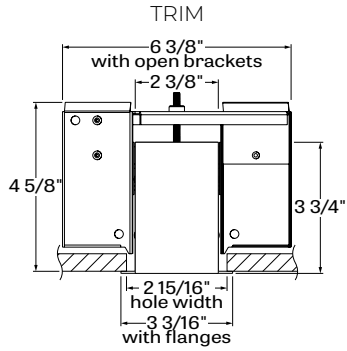

TG9
Tegular 9/16"

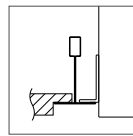

TG15
Tegular 15/16"

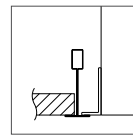

TB9
T-bar 9/16"

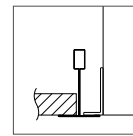

TB15
T-bar 15/16"

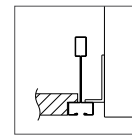

ST
Screw slot T-bar

LENS POSITIONS

Regressed Lens ¹

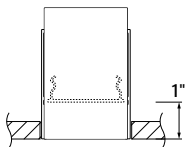

0.5" Drop Lens ¹

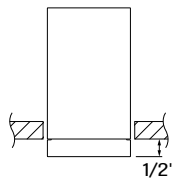

1.0" Drop Lens ¹

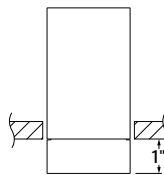

¹ Only available with HLO.

VIA 2 RECESSED

DIRECT
STATIC WHITE, BIOS

Multiple Flange Mounting Details

Multiple flange mounting can be specified when a fixture run needs to have a multiple flange recessed mounting detail. A drawing is required to clearly illustrate the application.

CEILING CONDITION EXAMPLES (consult factory for project specific ceiling conditions)

DRYWALL/GRID

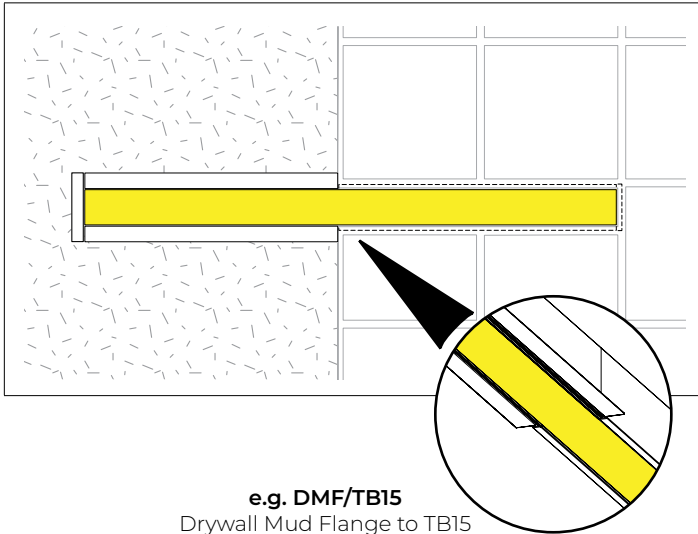

DRYWALL/WOOD

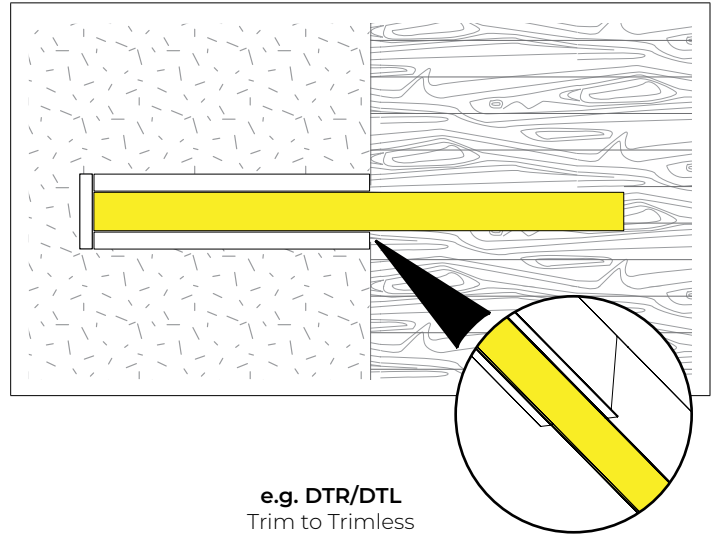

DRYWALL/GRID

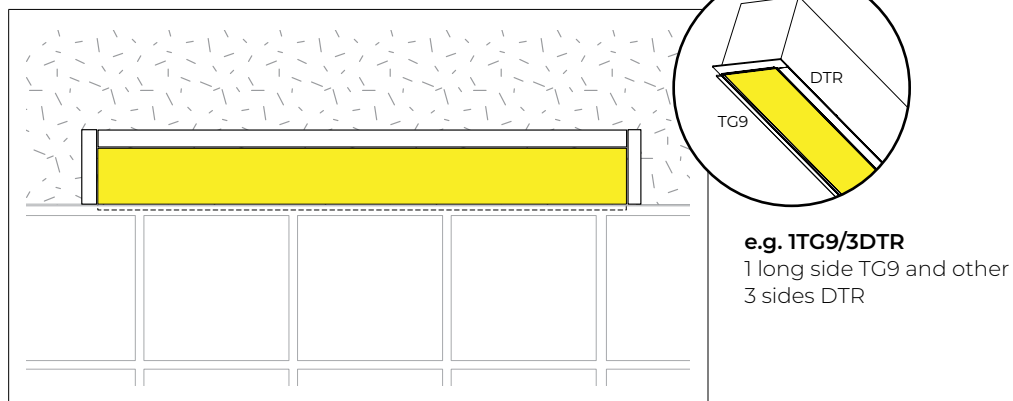

All drawings are for illustrative purposes only.

TRANSITION MOUNTING OPTIONS (consult factory for details)

Mounting condition alters along the run of the fixture.

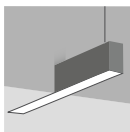

Recessed to Pendant

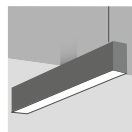

Surface to Pendant

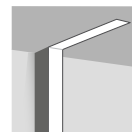

Surface to Recessed in corner

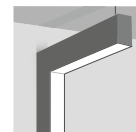

Surface to Pendant in corner

VIA 2 RECESSED



DIRECT
STATIC WHITE, BIOS

Photometrics

Values calculated based on a 4' fixture at 3500K for all optics.

HLO (Flush lens)

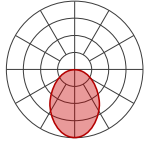

LM/FT	W/FT	LM/W
200	1.6	124
350	2.9	120
500	4.3	117
750	6.8	111
1000	9.4	106
1200	11.8	102

ARO2

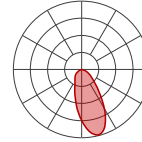

LM/FT	W/FT	LM/W
200	1.7	119
350	3.0	116
500	4.4	113
750	7.0	107
1000	9.7	103
1200	12.1	99

WRO2

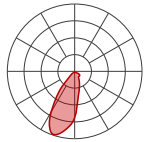

LM/FT	W/FT	LM/W
200	1.7	119
350	3.0	116
500	4.4	112
750	7.0	107
1000	9.8	102
1200	12.2	99

WDO

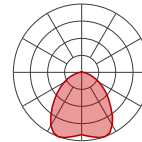

LM/FT	W/FT	LM/W
200	1.9	107
350	3.4	104
500	5.0	101
750	7.8	96
1000	11.0	91

LGO

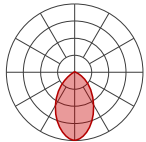

LM/FT	W/FT	LM/W
200	2.1	94
350	3.8	91
500	5.7	88
750	9.1	83

MPO

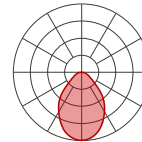

LM/FT	W/FT	LM/W
200	1.8	111
350	3.2	108
500	4.7	106
750	7.3	102
1000	10.2	98

DDO

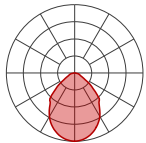

LM/FT	W/FT	LM/W
200	1.9	107
350	3.4	104
500	5.0	101
750	7.9	95
1000	10.9	92

MULTIPLIER TABLES

Use these tables to get results for different color temperatures and lens positions for all photometric tables.

Multiplier - CCT/CRI

CCT	WATTS		LPW	
	80+ CRI / 90+ CRI		80+ CRI / 90+ CRI	
2700K	1.05		0.95	
3000K	1.02		0.98	
3500K	1.00		1.00	
4000K	1.00		1.00	
5000K	0.96		1.04	

Multiplier - Lens position

DIRECT LENS	WATTS	LPW
Flush lens	1.00	1.00
Regressed lens	0.99	1.00
Drop lens 0.5"	0.99	1.00
Drop lens 1.0"	0.95	1.05

VIA 2 RECESSED



DIRECT
STATIC WHITE, BIOS

DOT 1.5" MODULE

Values calculated based on 3500K.

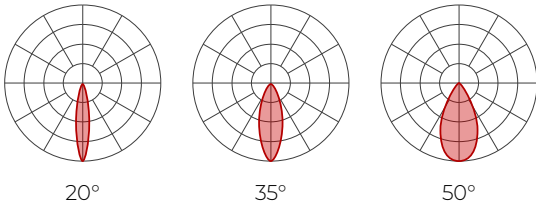

Delivered lumens (LM)

WATTAGE	LUMEN PACKAGE
12.2 W	900
15.9 W	1120

Efficacy (LM/W)

WATTAGE	EFFICACY
12.2 W	74
15.9 W	70

Please follow the multiplier table to ensure correct lumen value.

CCT	
2700K	0.94
3000K	0.96
3500K	1
4000K	1.02

PETITE MODULE

Values calculated based on 3500K.

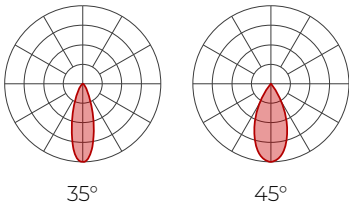

Delivered lumens (LM)

Baffle finish	White		Black, Champagne, Dark bronze		Satin silver, Matte silver		Glow ring	
	35°	45°	35°	45°	35°	45°	35°	45°
6 W	420	472	386	407	417	449	379	382
10 W	645	726	593	626	642	691	583	588

Efficacy (LM/W)

Baffle finish	White		Black, Champagne, Dark bronze		Satin silver, Matte silver		Glow ring	
	35°	45°	35°	45°	35°	45°	35°	45°
6 W	70	79	64	68	69	75	63	64
10 W	65	73	59	63	64	69	58	59

Please follow the multiplier table to ensure correct lumen value.

CCT	
2700K	0.94
3000K	0.98
3500K	1
4000K	1.05
5000K	1.05

VIA 2 RECESSED



DIRECT
STATIC WHITE, BIOS

BIOS

Three BIOS Circadian LED solutions are offered – Biological Static, Biological Dynamic, and Biological Tunable. Use the decision tree below to identify when and where to use BIOS Wellness LED Lighting Solutions.

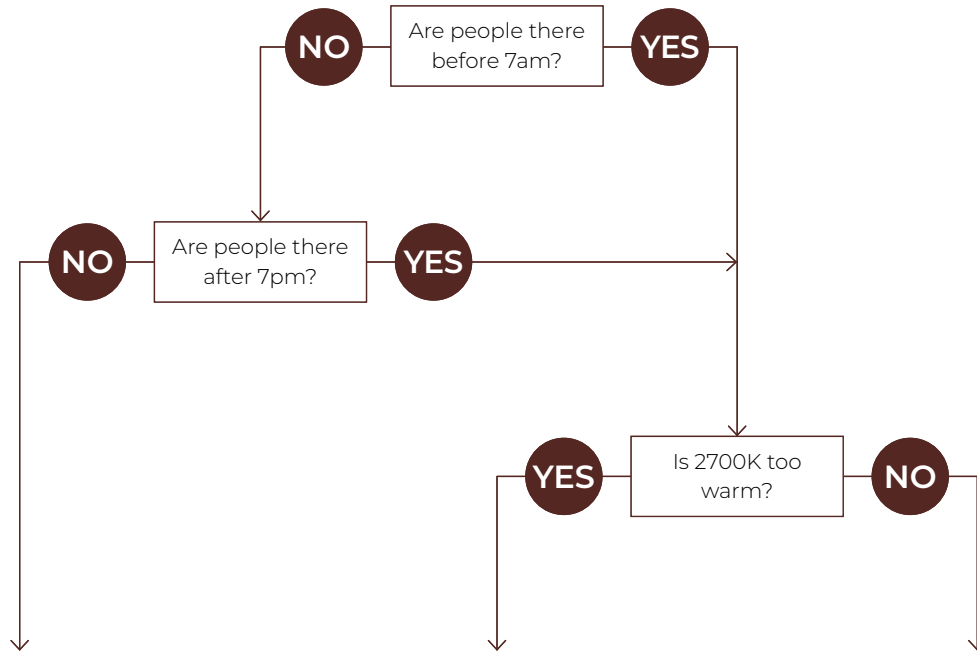

Biological Static BIOSST	Biological Dynamic BIOSDY	Biological Tunable BIOSTU
No CCT change when dimmed e.g. 40K - 4000K stays as 4000K when dimmed	500K shift when dimmed e.g. 40K - 4000K changes to 3500K when dimmed	Dims to 2700K e.g. 40K - 4000K changes to 2700K when dimmed
Daytime solution	Daytime + evening solution	Daytime + evening solution
Spaces in operation during daytime hours, between 7am and 7pm	Spaces in operation overnight, after 7pm and before 7am, and when CCT color shift in the evening is not preferred	Suitable for spaces in operation overnight, after 7pm and before 7am, and where people do not sleep (CCT color shift in the evening is preferred)
E.g. offices, medical/dental offices	E.g. hospitals	E.g. offices, shiftwork

VIA 2 RECESSED

DIRECT
STATIC WHITE, BIOS



Technical Specifications

OPTICS

High-Efficiency Lambertian Optic (HLO)

The High-Efficiency Lambertian Optic (HLO) uses matte white reflectors to distribute LED output across 0.075" acrylic shielding, providing up to 88% transmission and good obscuration. Available with different lens position options, HLO has a spacing criterion of 1.06.

Asymmetric Refractive Optic (ARO2)

The Asymmetric Refractive Optic (ARO2) uses a sophisticated reflector combined with a matte beam-shaping film to create a smooth, effective downward light component without shadows or hot spots. It provides directional Gaussian light distribution with peak intensity at 20° above nadir and a 55° Full Width at Half Maximum (FWHM) beam angle. Microstructure material applied to the snap-in lens provides the precise refractive power and visual comfort, while achieving a high luminous efficacy.

Wall Wash Refractive Optic (WRO2)

The Wall Wash Refractive Optic (WRO2) delivers smooth vertical illumination with a gentle gradient and soft visual cut-off. Its exacting configuration creates a strong downward light component without shadows or hot spots and provides light distribution with peak intensity at 21° above nadir. Microstructure material applied to the snap-in lens provides the precise refractive power and visual comfort, while achieving a high luminous efficacy.

Widespread Direct Optic (WDO)

The Widespread Direct Optic (WDO) is designed to distribute light far and wide. As such, it has an excellent luminous efficacy, a light span that is 40% farther than that of our traditional HLO, and it maximizes spacing distance while still creating a sense of uniformity. The lens snaps into place and utilizes nano prismatic optics to mask the diodes that are actually emitting the light.

Low-Glare Optic (LGO)

The Low-Glare Optic (LGO) is designed to cut off high-angled light and control glare. The carefully crafted lens refracts light downward through its center from which it then disperses into a wide conical distribution that negates any illumination at about 40°. The LGO provides the visual comfort of a louver in a smooth acrylic lens.

Micro-Prismatic Optic (MPO)

The Micro-Prismatic Optic (MPO) delivers high-efficiency, low-glare illumination with UGR <17. Its precision-engineered lens, composed of thousands of tiny prisms, diffuses light to reduce glare, producing a ceiling plane that reads smooth from a distance while revealing subtle texture up close. The result is balanced, efficient illumination with a refined architectural presence.

Domed Deglare Optic (DDO)

The Domed Deglare Optic (DDO) features a transparent, domed lens that delivers low-glare illumination and visual comfort with a refined textured presence on the ceiling plane.

LIGHT SOURCE

Static white

Custom linear array of mid-flux LEDs are cartridge-mounted with quick-connect wiring to facilitate service and thermal management. Available in 2700K, 3000K, 3500K, 4000K, and 5000K with a minimum 80+ CRI and an option for 90+ CRI with elevated R9 value. Color consistency maintained to within 3 SDCM. All LEDs have been tested in accordance with IESNA LM-80-08 and the results have shown L80 lumen maintenance greater than 60,000 hours. Absolute product photometry is measured and presented in accordance with IESNA LM-79, unless otherwise indicated.

VIA 2 RECESSED



DIRECT
STATIC WHITE, BIOS

BIOS

BIOS SkyBlue™ Technology is designed to provide the specific circadian stimulus to improve overall sleep quality, recovery during the night, and overall feelings of well-being. The non-visual light signals that stimulate our circadian system have peak intensity in the "sky blue" region. As the diagram below illustrates, BIOS SkyBlue technology shifts the peak LED spectral intensity (490 nm) to align better with the peak response of circadian stimulus. Also note the enhanced deep-red (near 660 nm) spectrum.

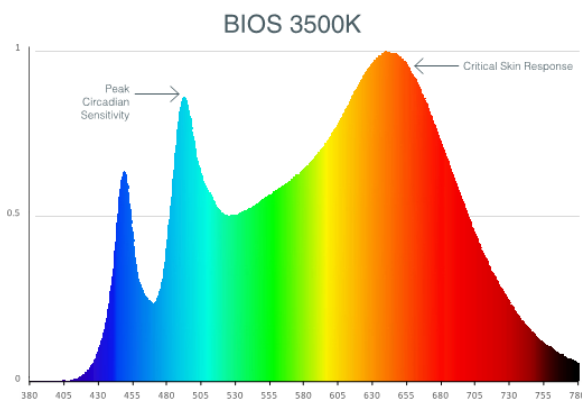

Three BIOS solutions are offered: BIOS Biological Static (BIOSST), BIOS Biological Dynamic (BIOSDY), and BIOS Biological Tunable (BIOSTU). See page 8 for details.

LUMINAIRE LENGTH

Via 2 is available in standard lengths of 2' to 12' (up to 8' for MPO and DDO). Continuous runs are available for run lengths over 12' (8' for MPO and DDO). Exact run length must be noted in the product code. The minimum length is 2', and can be ordered in 1' and/or 1" increments, and 2' increments for BIOSTU and BIOSDY. All individual sections are joined together onsite using the joiner kits provided. Lumenwerx offers joiner kits that are extremely simple to work with in the field and result in a fixture that appears virtually seamless with no light leak at any connection.

ELECTRICAL

Factory-set, adjustable output current LED driver with universal (120-277 VAC) input. Dimmable from 100% to 1% with 0-10V dimming control. Rated life (90% survivorship) of 50,000 hours at 50°C max. ambient (and 70°C max. case) temperature. At maximum driver load: Efficiency > 84%, PF > 0.9, THD < 20%. Other specifiable options include Lutron Hi-Lume 1% Eco, eldoLED 1% ECOdrive 0-10V, eldoLED 0.1% SOLOdrive 0-10V, ELV, TRIAC, and DALI protocol drivers. All of our standard 0-10V drivers are NEMA 410 compliant. ELV and TRIAC dimming performance (including minimum dimming percentage) subject to dimmer selection.

PoE

Depending on the PoE manufacturer selected, Lumenwerx will install the node in factory as either integral to the luminaire or as a remote module. Factory programming of the PoE node may or may not enable the following functionalities: lumen package, DUO (tunable white), QUADRO (RGBW), emergency battery backup, and sensor integration. These must be addressed and evaluated on a case-by-case basis.

ELECTRICAL SECTION OPTIONS

Electrical section options are available for fixtures specified as multi circuit (#MC). With MC, specify the total number of circuits (#), including any circuits required for optional electrical sections. A drawing is required to specify the layout. Please consult factory for custom configurations.

Electrical sections

Options include emergency-powered (#EC##), night light (#NL##), daylight (#DL##), and generator transfer device (#GTD##) sections. Specify the quantity (#), as well as the section length in inches (##).

Example 1: A 32' Direct fixture with two 8' emergency-powered sections on a second circuit.

Code: 2MC-2EC96

Example 2: A 24' Direct fixture with one 4' generator transfer device section.

Code: 1MC-1GTD48

Battery

Each emergency battery (#EMB) powers a 4' section. All batteries will be on the same circuit. Specify the number of batteries (#) required.

Factory installed long life, high temperature, maintenance-free Lithium-Ion battery pack with self-test functionality, test switch and charge indicator. Minimum of 90 minutes operation, up to 1000 lumens per 4' (25°C) emergency lighting output and recharge time of 24 hours.

MOUNTING

Recessed fixtures can be mounted into exposed or concealed T-bar or tegular ceiling, as well as in ceilings with trim, trimless, or mud flange options.

FINISH

Interior: 95% reflective matte powder coated white paint

Exterior: Matte white or matte black powder coating. Custom finishes are also available.

VIA 2 RECESSED



DIRECT
STATIC WHITE, BIOS

CONTROLS

Lumenwerx offers several options for integrating occupancy and daylight harvesting controls in our luminaires. For latest information on sensors, click [here](#).



Standalone controls

An integrated standalone sensor controls the luminaire in which it is installed. Depending on the length, more than one sensor may be necessary and may control the entire luminaire, or just a section of it. These controls operate independently. Unless otherwise agreed, sensor location, blank size, and functionality of the sensor within the luminaire are selected by Lumenwerx. See client drawings for details.

Three types are available:

OMS: An integral Passive InfraRed (PIR) sensor turns luminaires on and off automatically with field-adjustable time out period. No wall control is used. Coverage pattern for large motion has a 12' diameter with the sensor mounted 8' above the floor; for small motion, the pattern has an 8' diameter. Typically, one sensor is required for every 10' of a continuous luminaire run.

ODS: An integral, daylight harvesting sensor with closed-loop operation dims the luminaire in which it is installed in order to compensate for available daylight. The sensor measures the combination of daylight and luminaire light reflected from horizontal surfaces below the luminaire. Initial onsite calibration is required via the use of provided remote control.

OCS: Both an occupancy and a daylight sensor are installed in the luminaire.

Connected controls

With connected controls, sensors or nodes installed in the luminaire form part of a larger control system infrastructure from manufacturers such as: Lutron, Encelium, Cooper Wavelinx, Acuity nLight, Casambi, Legrand, and others. These connected controls allow for a scalable system providing features like occupancy and daylight control, manual control, scheduling and configuration of various zones and scenes. Energy reporting and system monitoring are also possible. Specific capabilities depend on the control system being used.

Lumenwerx installs the components (sensors, nodes, power packs, etc) which may be supplied to us by a third party, or procured directly by Lumenwerx, depending on the control system manufacturer.

Lumenwerx is solely responsible for the installation of specified components; the controls manufacturer is responsible for performance of the control system.

To indicate a Lumenwerx luminaire with connected controls, identify the specific onsite control system to be integrated into the luminaires using the ordering code. Due to the diversity of components, you must contact factory to assure complete compatibility with intended control system and to fully specify the luminaire.

Complete control specifications, sensor/node/power pack layout, and narrative for the control system are required for Lumenwerx to create shop drawings and submittals.

INTEGRATED TRACK

The integrated track is available with single units and continuous runs, with or without sections of integrated LED.

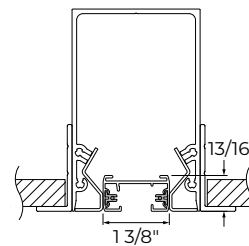

GES

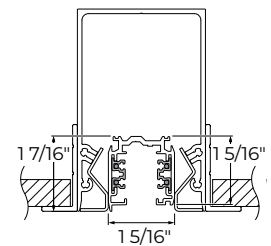

TEK / HTEK / XTS / XTSC

DOT MODULE

Dot is a round spotlight that rotates 360° and tilts 90°, available in three beam angles of 20°, 35°, and 50°. LED light source CCT options are 2700K, 3000K, 3500K, and 4000K available in either 80+ CRI or 90+ CRI. Offered in 4" height with two baffle options: standard and decorative. Dot is available in a white, black, or custom finish.

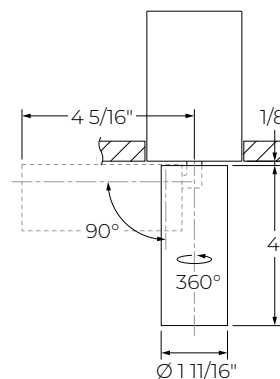

Dot 1.5" - Standard baffle

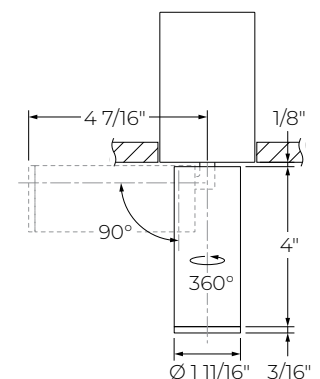

Dot 1.5" - Decorative baffle

VIA 2 RECESSED



DIRECT
STATIC WHITE, BIOS

PETITE MODULE

Petite 1" Downlight is offered in two options: trimless and glow ring. It is available in two beam angles of 35° and 45°. LED light source CCT options are 2700K, 3000K, 3500K, 4000K, and 5000K available in either 80+ CRI or 90+ CRI. The trimless model is available in a wide range of colors.

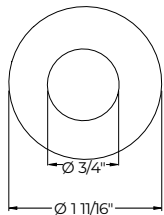

Petite
(PET1)

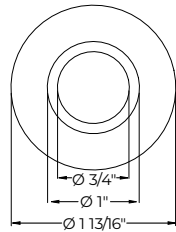

Petite with glow ring
(PETIGLR)

CONSTRUCTION

Housing: Extruded aluminum, up to 90% recycled content

Interior brackets: Die-formed cold rolled sheet steel

Joining system: Die-cast zinc

Reflectors: Die-formed cold rolled steel, 95% reflective matte white painted

Lens: Acrylic

Drop lens: Extruded with glued end caps

Recessed flanges: Extruded aluminum, up to 90% recycled content

Mud flange: Extruded aluminum, up to 90% recycled content

Slip-through bracket: Die-formed galvanized sheet

End plate: Die-formed cold rolled sheet steel

WEIGHT

4': 9.03 lbs - 4.1 kg

8': 18.28 lbs - 8.3 kg

12': 27.97 lbs - 12.7 kg

CERTIFICATIONS

ETL: Rated for indoor dry/damp locations. Conforms to UL Standard 1598 and certified to CAN/CSA Standard C22.2 No. 250.0.

Chicago Plenum: City of Chicago Approved (CCEA) when specified with CP option.

IC rated: Suitable for direct contact with insulation

Declare: [LBC Red List Approved](#)

WARRANTY

Lumenwerx provides a five-year limited warranty on electrical and mechanical performance of the luminaires, including the LED boards, drivers, and auxiliary electronics. Lumenwerx will repair or replace defective luminaires or components at our discretion, provided they have been installed and operated in accordance with our specifications. Other limitations apply, please refer to the full warranty on our website.