

VIA 2 RECESSED PATTERN

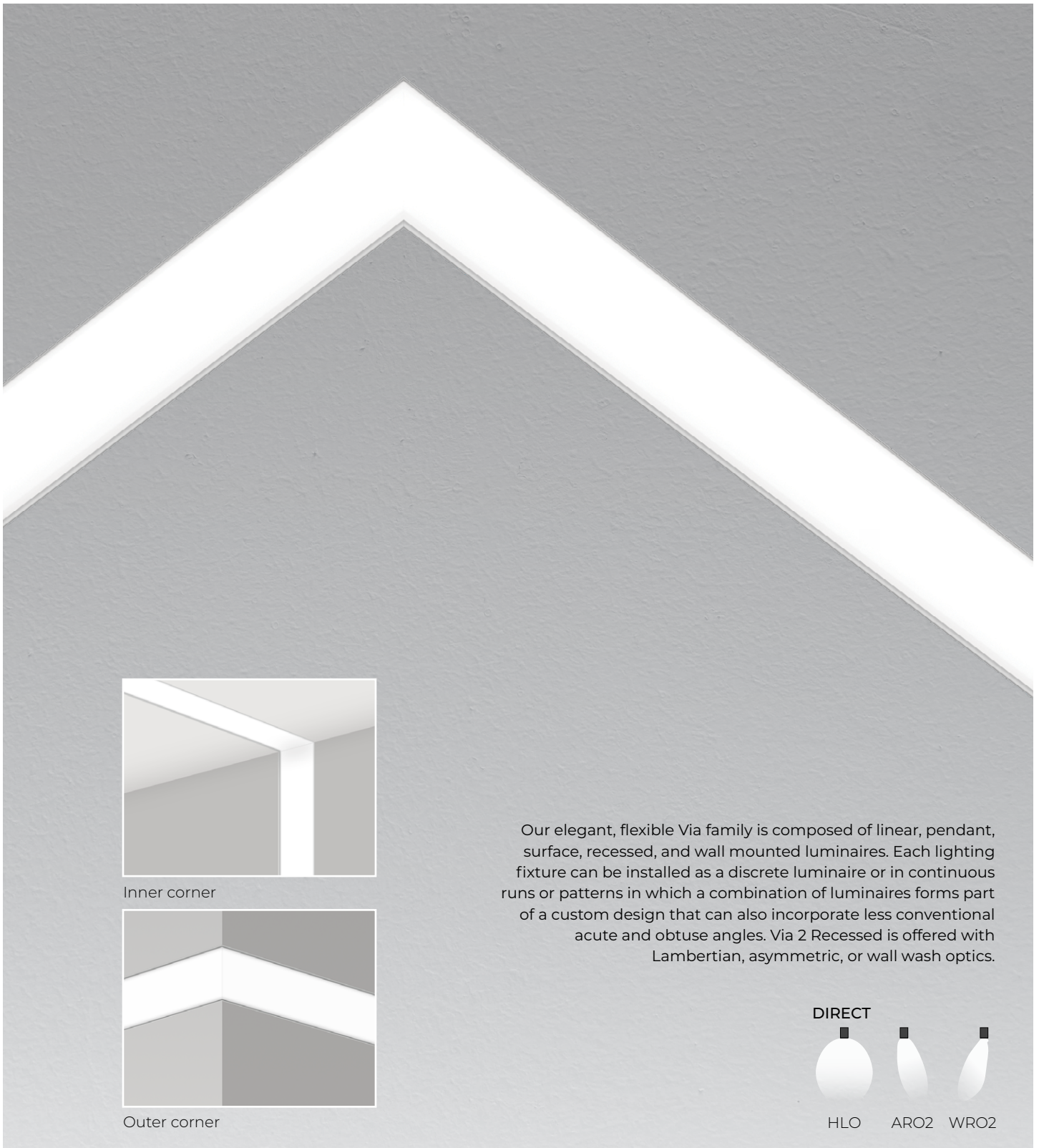

DIRECT
CHROMAWERX - SOLA, DUO

IC RATED **Declare.**



Inner corner

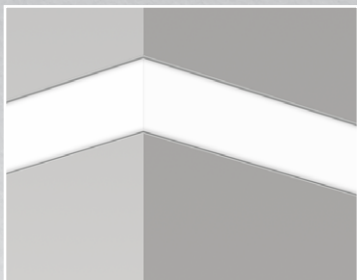

Outer corner

Our elegant, flexible Via family is composed of linear, pendant, surface, recessed, and wall mounted luminaires. Each lighting fixture can be installed as a discrete luminaire or in continuous runs or patterns in which a combination of luminaires forms part of a custom design that can also incorporate less conventional acute and obtuse angles. Via 2 Recessed is offered with Lambertian, asymmetric, or wall wash optics.

DIRECT



HLO



ARO2



WRO2

VIA 2 RECESSED PATTERN



DIRECT
CHROMAWERX - SOLA, DUO

Project: _____

Type: _____

Order Guide

A drawing of your pattern is required - anything from a line drawing to an architectural drawing.

LUMINAIRE ID	DISTRIBUTION	OPTIC	LENS POSITION	LIGHT SOURCE ²	CRI
VIA2RPAT	D				
VIA2RPAT - Via 2" Recessed Pattern	D - Direct	HLO - High-Efficiency Lambertian Optic ARO2 - Asymmetric Refractive Optic WRO2 - Wall Wash Refractive Optic	FH ¹ - Flush RG ¹ - Regressed 0.5D ¹ - 0.5" drop 1.0D ¹ - 1.0" drop ¹ For HLO, specify FH, RG, 0.5D, or 1.0D. [•] For ARO2 and WRO2, specify FH.	SOLA - Dim-to-warm single channel control 35K to 22K DUO - Tunable white 2-channel control 65K to 27K ² Static white, BIOS, and Chromawerx QUADRO also available. Consult other spec sheets.	80CRI - 80+ CRI 90CRI - 90+ CRI

LUMEN PACKAGE	PATTERN LENGTH	CORNER TYPE ⁶	VOLTAGE
200LMF ³ - Hypo output 200 lm/ft 350LMF - Low output 350 lm/ft 500LMF - Medium output 500 lm/ft 750LMF - High output 750 lm/ft 1000LMF - Ultra high output 1000 lm/ft 1200LMF ⁴ - Hyper output 1200 lm/ft ³ Minimum 4' fixture. ⁴ Fixture will be very bright. Use in suitable applications.	##FT##IN(##X##FT##IN-##X##FT##IN-...) ⁵ - ##FT##IN: total nominal length of pattern in feet and/or inches ##X: quantity of each section ##FT##IN: nominal length of each section in feet and/or inches Continuous runs: lengths over 12' ^{5•} Minimum 2'. - Minimum 4' for DMX.	#LEV2C(A##) - 2-way leveled corner #LEV3C(A##) ^{7,8} - 3-way leveled corner #LEV4C(A##) ^{7,8} - 4-way leveled corner #INN2C(A90) ^{8,9} - 2-way inner corner #OUT2C(A90) ^{8,9} - 2-way outer corner ⁶ Specify quantity (#) and angle (A##) for each required corner type. If more than one option is specified, separate codes with a "+", e.g. 1LEV2C(A90)+2LEV2C(A60). ⁷ Separate angles with a "*" if more than one type is required, e.g. 1LEV4C(A60+A120). ⁸ Not available with ARO2/WRO2. ⁹ Available with 90° only. Consult factory for other angles. ¹⁰ Minimum angle is 30°. For ARO2/WRO2, minimum angle is 75°.	ANGLE (A##): (A60) ⁹ - 60° (A90) - 90° (A120) - 120° (A##) ¹⁰ - Custom 120V - 120V 277V - 277V UNV - 120V-277V

DRIVER ¹¹	ELECTRICAL	MOUNTING CEILING ¹⁴	MOUNTING WALL ¹⁶	FINISH	OPTIONS ¹⁷
SOLA SD1 - Single 0-10V input DUO DMX ^{12,13} - DMX DDA ¹³ - DALI DT6 DDA8 ¹³ - DALI DT8 DD1 - Dual 0-10V input for CCT/intensity LD2 ¹³ - Lutron DALI-2 digital ¹¹ PoE (Power-over-Ethernet) compatible. Consult factory for details. ¹² For more information, see pages 9 to 14. ¹³ On-site commissioning is required.	1C - 1 circuit	TC9 - Tegular 9/16" TG15 - Tegular 15/16" TB9 - T-bar 9/16" TB15 - T-bar 15/16" ST - Screw slot T-bar DTR - Trim DTL - Trimless DMF - Drywall mud flange NA - Not applicable MFM ¹⁵ - Multiple flange mounting ¹⁴ Transition mounting options also available (e.g. Recessed to Pendant/Surface), consult factory for details. ¹⁵ See page 4 for details.	DTR - Trim DTL - Trimless DMF - Drywall mud flange NA - Not applicable ¹⁶ Not available with leveled corners.	W - Matte white B - Matte black CF# - Custom finish, specify RAL#	FU120 - Fuse 120V FU277 - Fuse 277V FWC - Flexible whip cable (6' std) CP - Chicago Plenum NA - None ¹⁷ Separate codes with a "+" if more than one is specified.

Accessories

Optional, order separately

WALL CONTROLLER ¹⁸	
DMX WCW##FT ¹⁹ - DMX wall controller white WCB##FT ¹⁹ - DMX wall controller black ¹⁸ Specify wire length (##) in feet. ¹⁹ Available with DMX only. For more information, see pages 9 to 14, or consult factory. ²⁰ Available with DDI only. For more information, see page 15, or consult factory.	DDI TWCW##FT ²⁰ - Dual 0-10V wall controller white TWCB##FT ²⁰ - Dual 0-10V wall controller black

VIA 2 RECESSED PATTERN



DIRECT
CHROMAWERX - SOLA, DUO

Dimensions

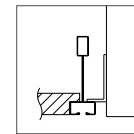
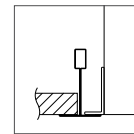
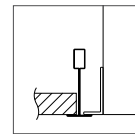
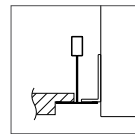
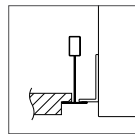
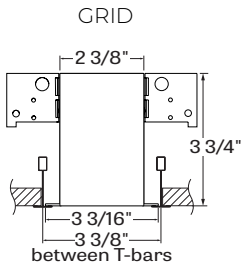
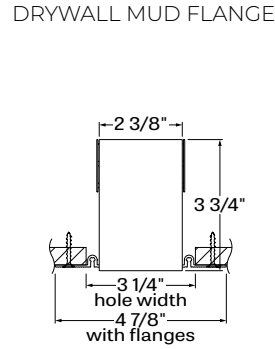
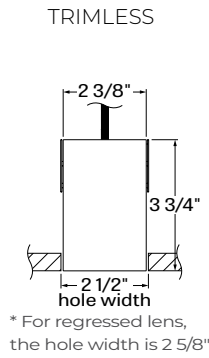
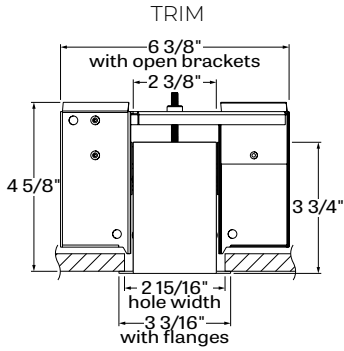

LENS POSITIONS

Regressed Lens ¹

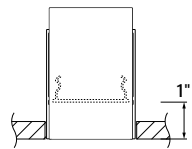

0.5" Drop Lens ¹

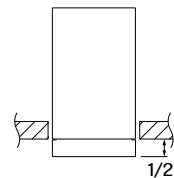

1.0" Drop Lens ¹

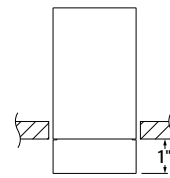

¹ Regressed lens and drop lens positions available with HLO only.

VIA 2 RECESSED PATTERN

DIRECT
CHROMAWERX - SOLA, DUO

Multiple Flange Mounting Details

Multiple flange mounting can be specified when a fixture run needs to have a multiple flange recessed mounting detail. A drawing is required to clearly illustrate the application.

CEILING CONDITION EXAMPLES (consult factory for project specific ceiling conditions)

DRYWALL/GRID



e.g. DMF/TB15
Drywall Mud Flange to TB15

DRYWALL/WOOD

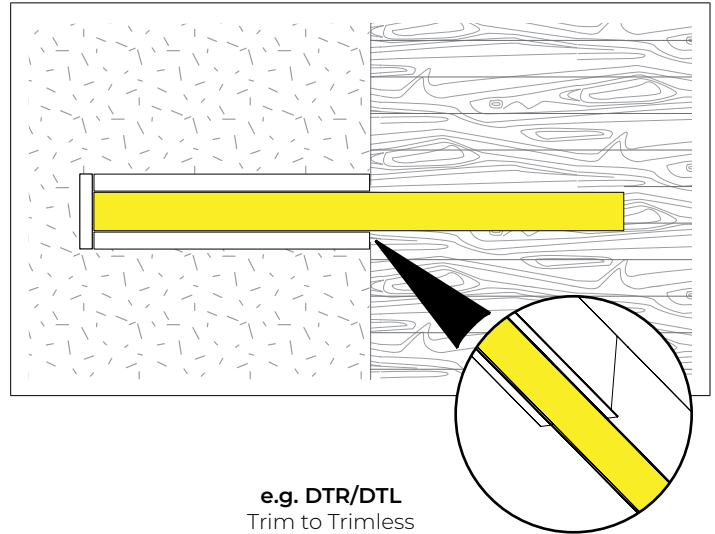

e.g. DTR/DTL
Trim to Trimless

DRYWALL/GRID

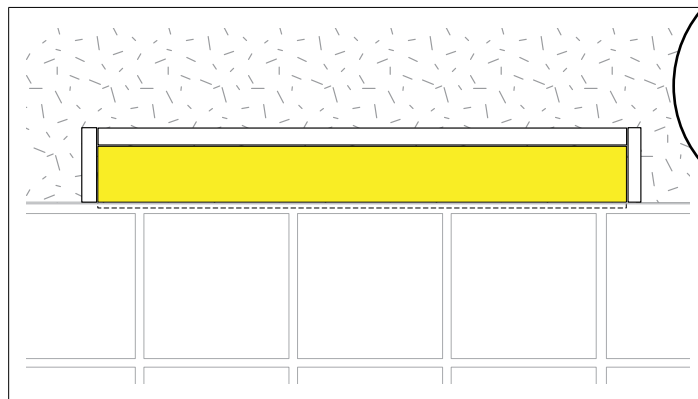

e.g. 1TG9/3DTR
1 long side TG9 and other
3 sides DTR

All drawings are for illustrative purposes only.

TRANSITION MOUNTING OPTIONS (consult factory for details)

Mounting condition alters along the run of the fixture.

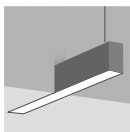

Recessed to Pendant

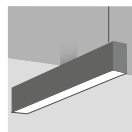

Surface to Pendant

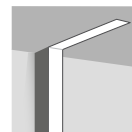

Surface to Recessed in corner

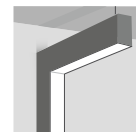

Surface to Pendant in corner

VIA 2 RECESSED PATTERN



DIRECT
CHROMAWERX - SOLA, DUO

Pattern Layout

CORNER TYPES

LEVELED CORNERS

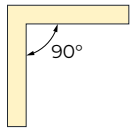

1LEV2C(A90)

2-way

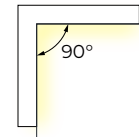

1INN2C(A90)

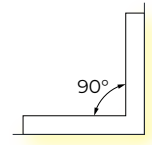

1OUT2C(A90)

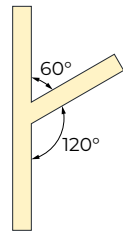

1LEV3C(A60+A120)

3-way

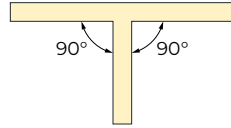

1LEV3C(A90+A90)

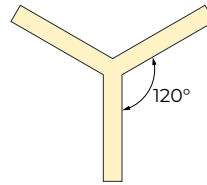

1LEV3C(A120)

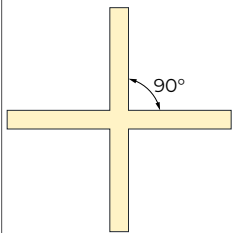

1LEV4C(A90)

4-way

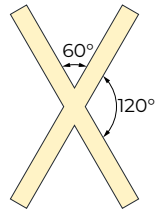

1LEV4C(A60+A120)

EXAMPLES

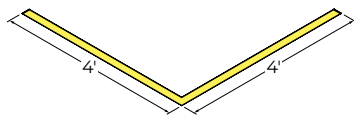

8FT(2X4FT)-1LEV2C(A90)

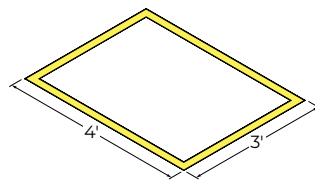

14FT(2X4FT-2X3FT)-4LEV2C(A90)

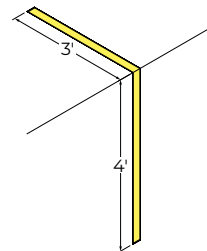

7FT(1X3FT-1X4FT)-1INN2C(A90)

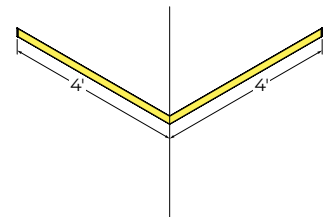

8FT(2X4FT)-1OUT2C(A90)

VIA 2 RECESSED PATTERN



DIRECT

CHROMAWERX - SOLA, DUO

Photometrics

Values calculated based on a 4' fixture at 3500K for all optics.

HLO (Flush lens)

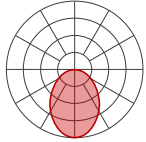

LM/FT	W/FT	LM/W
200	1.6	124
350	2.9	120
500	4.3	117
750	6.8	111
1000	9.4	106
1200	11.8	102

ARO2

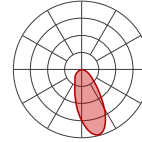

LM/FT	W/FT	LM/W
200	1.7	119
350	3.0	116
500	4.4	113
750	7.0	107
1000	9.7	103
1200	12.1	99

WRO2

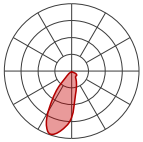

LM/FT	W/FT	LM/W
200	1.7	119
350	3.0	116
500	4.4	112
750	7.0	107
1000	9.8	102
1200	12.2	99

MULTIPLIER TABLES

Use these tables to get results for different color temperatures and drop lenses for all photometric tables.

SOLA

CCT	WATTS	LPW
	80+ CRI / 90+ CRI	80+ CRI / 90+ CRI
3500K	1.00	1.00

DUO

CCT	WATTS	LPW
	80+ CRI / 90+ CRI	80+ CRI / 90+ CRI
2700K	1.05	0.95
6500K	1.00	1.00

Multiplier - Drop lens

DIRECT LENS	WATTS	LPW
Flush lens	1.00	1.00
Drop lens 0.5"	0.99	1.00
Drop lens 1.0"	0.95	1.05

DIRECT

CHROMAWERX - SOLA, DUO

Technical Specifications

OPTICS

High-Efficiency Lambertian Optic (HLO)

The High-Efficiency Lambertian Optic (HLO) uses matte white reflectors to distribute LED output across 0.075" acrylic shielding, providing up to 88% transmission and good obscuration.

Available as a flush lens or as a drop lens, the HLO has a spacing criterion of 1.06.

Asymmetric Refractive Optic (ARO2)

The Asymmetric Refractive Optic (ARO2) uses a sophisticated reflector combined with a matte beam-shaping film to create a smooth, effective downward light component without shadows or hot spots. It provides directional Gaussian light distribution with peak intensity at 20° above nadir and a 55° Full Width at Half Maximum (FWHM) beam angle. Microstructure material applied to the snap-in lens provides the precise refractive power and visual comfort, while achieving a high luminous efficacy.

Wall Wash Refractive Optic (WRO2)

The Wall Wash Refractive Optic (WRO2) delivers smooth vertical illumination with a gentle gradient and soft visual cut-off. Its exacting configuration creates a strong downward light component without shadows or hot spots and provides light distribution with peak intensity at 21° above nadir. Microstructure material applied to the snap-in lens provides the precise refractive power and visual comfort, while achieving a high luminous efficacy.

LIGHT SOURCE

Custom linear array of alternating color temperature mid-flux LEDs are mounted directly to the housing for optimal thermal performance. For the DUO products, a color temperature range from 6500K-2700K is achievable with color points on or below the black body curve. For the SOLA products, a color temperature range from 3500K-2200K is controlled synchronously with intensity. Color consistency between fixtures is maintained to within 3 SDCM. All LEDs have been tested in accordance with IESNA LM-80-08 and the results have shown L80 lumen maintenance greater than 60,000 hours. Absolute product photometry is measured and presented in accordance with IESNA LM-79, unless otherwise indicated.

Chromawerx SOLA

It is a single-channel control that dims output while warming the color temperature in a pre-determined relationship. A simple analog control sends a common signal to dual output digital drivers, which are programmed to adjust a specially populated LED array to emulate the effect of dimming a filament source. Dimming range is programmable but the default option runs from 3500K at 100% of full power to 2200K at 5% of full power. CRI is maintained above 80 throughout the dimming range.

Chromawerx DUO

It is a two-channel control. It uses an analog (0-10V) protocol for separate control of luminaire CCT and intensity or a digital (DMX, DALI, and LD2) protocol for synchronous control of both warm and cool LED arrays to enable the user to set color temperature and light output. Commonly called "tunable white", Chromawerx two-channel control provides the range of cool (6500K) to warm (2700K) color that can be useful for helping to entrain circadian rhythms, stimulate alertness for improved educational and work productivity, and compensate for jet lag, among other applications. The Chromawerx drivers are programmed to limit maximum light output and power usage across all color temperatures. CRI is maintained above 80. When paired with DALI drivers (DDA/DDA8), color tuning follows a linear dimming curve.

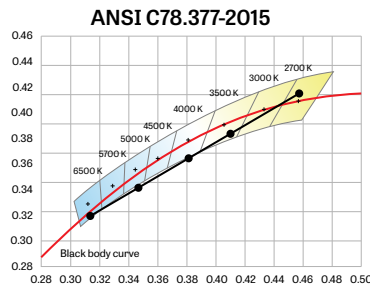

PATTERN LENGTH

All individual sections are joined together onsite using the joiner kits provided. Lumenwerx offers joiner kits that are extremely simple to work with in the field and result in a fixture that appears virtually seamless with no light leak at any connection.

ELECTRICAL

SOLA

SDI

Factory-set, adjustable output current LED driver with universal (120-277 VAC) input. Using a single 0-10V control signal, the light output warms in color temperature as it dims down to 1% and 2200K. At maximum driver load, efficiency<86%, PF>0.9, THD<20%.

DUO

DMX

Factory-set adjustable output current electronic driver with 120-277 VAC line input. Using DMX wall controls (optionally supplied by Lumenwerx) or an existing DMX control system, both channels of LEDs are independently adjustable. Each DMX driver can be independently addressed using the built-in RDM (Remote Device Management) in the field. Dimming down to 1% is attainable. Rated life (90% survivorship) of 50,000 hours at 50°C maximum ambient temperature. At maximum driver load, efficiency<84%, PF>0.9, THD<20%.

VIA 2 RECESSED PATTERN



DIRECT

CHROMAWERX - SOLA, DUO

DALI

Factory-set adjustable output current electronic driver with 120-277 VAC line input. Using an existing DALI control system (supplied by others), one control channel adjusts the fixture color temperature, and the other control channel adjusts fixture brightness. With DALI Type 6, two DALI addresses are required to control both channels. With DALI Type 8, one DALI address is required to control both channels. Dimming down to 1% is attainable. Rated life (90% survivorship) of 50,000 hours at 50°C maximum ambient temperature. At maximum driver load, efficiency < 84%, PF > 0.9, THD < 20%.

DD1

Factory-set adjustable output current LED driver with universal (120-277 VAC) input. Controlled via two individual 0-10V signals, one for setting light output down to a minimum of 1% and the other for adjusting the CCT (default range of 6500K-2700K). Rated life of 50,000 hours at 70°C maximum driver case temperature and 100% load conditions. Typical efficiency of 86%, PF > 0.9, THD < 20% at 100% load conditions.

LD2

Lutron DALI-2 digital drivers provide a high-performance tunable white solution with single-address digital control. Guaranteed performance and compatibility when used with Lutron DALI-2 controls.

PoE

Depending on the PoE manufacturer selected, Lumenwerx will install the node in factory as either integral to the luminaire or as a remote module. Factory programming of the PoE node may or may not enable the following functionalities: lumen package, DUO (tunable white), QUADRO (RGBW), emergency battery backup, and sensor integration. These must be addressed and evaluated on a case-by-case basis.

MOUNTING

Recessed fixtures can be mounted into exposed or concealed T-bar or tegular ceiling, as well as in ceilings with trim, trimless, or mud flange options.

FINISH

Interior: 95%, reflective matte powder coated white paint

Exterior: Matte white or matte black powder coating. Custom finishes are also available.

CONSTRUCTION

Housing: Extruded aluminum, up to 90% recycled content

Interior brackets: Die-formed cold rolled sheet steel

Joining system: Die-cast zinc

Reflectors: Die-formed cold rolled steel, 95% reflective matte white painted

Lens: Acrylic

Drop lens: Extruded with glued end caps

Recessed flanges: Extruded aluminum, up to 90% recycled content

Mud flange: Extruded aluminum, up to 90% recycled content

Slip-through bracket: Die-formed galvanized sheet

End plate: Die-formed cold rolled sheet steel

CERTIFICATIONS

ETL: Rated for indoor dry/damp locations. Conforms to UL Standard 1598 and certified to CAN/CSA Standard C22.2 No. 250.0.

Chicago Plenum: City of Chicago Approved (CCEA) when specified with CP option.

IC rated: Suitable for direct contact with insulation

Declare: [LBC Red List Approved](#)

WARRANTY

Lumenwerx provides a five-year limited warranty on electrical and mechanical performance of the luminaires, including the LED boards, drivers, and auxiliary electronics. Lumenwerx will repair or replace defective luminaires or components at our discretion, provided they have been installed and operated in accordance with our specifications. Other limitations apply, please refer to the full warranty on our website.

Wall controllers are covered by the manufacturer warranty.

VIA 2 RECESSED PATTERN



DIRECT

CHROMAWERX - SOLA, DUO

DUO DMX SPECIFICATION

A qualified DMX integrator is required to assure proper installation and commissioning of the DMX network. **When placing the PO, please provide the contact information of your DMX integrator.**

Please answer the following questions to help us identify your DMX network requirements.

YES

Do you require a wall controller provided by Lumenwerx?

NO

DMX control system supplied by others. Lumenwerx will supply DMX-enabled fixtures with default DMX addressing. See following pages for technical DMX informations. ✓

DMX controller supplied by Lumenwerx

How many zones do you have?

A zone consists of one or more luminaires behaving identically.



1 Zone



2 Zones

How to calculate the required number of drivers:

per 4' fixture

Driver
1x driver

Direct only

per 4' fixture

Driver Driver
2x driver

Direct high output

To Calculate # of drivers

1 - 4 Zones

5 or more Zones

Do you have more than 32 drivers in total?

NO

YES

Order a standard Lumenwerx wall controller.

WALL CONTROLLER

WCW - wall controller white
WCB - wall controller black

Add the control code at the end of your order code.

Please provide a fixture layout or RCP (Reflected Ceiling Plan) showing the locations of the DMX fixtures, zones and the DMX wall controller.

Refer to your DMX integrator for the installation. ✓

Subject to factory evaluation. Please contact our controls specialist at controls@lumenwerx.com. Additional cost and equipment will be required. ✓

Subject to factory evaluation and approval. Please contact our controls specialist at controls@lumenwerx.com. Additional cost and equipment will be required. ✓

VIA 2 RECESSED PATTERN

DIRECT
CHROMAWERX - SOLA, DUO

GENERIC DMX NETWORK ARCHITECTURE

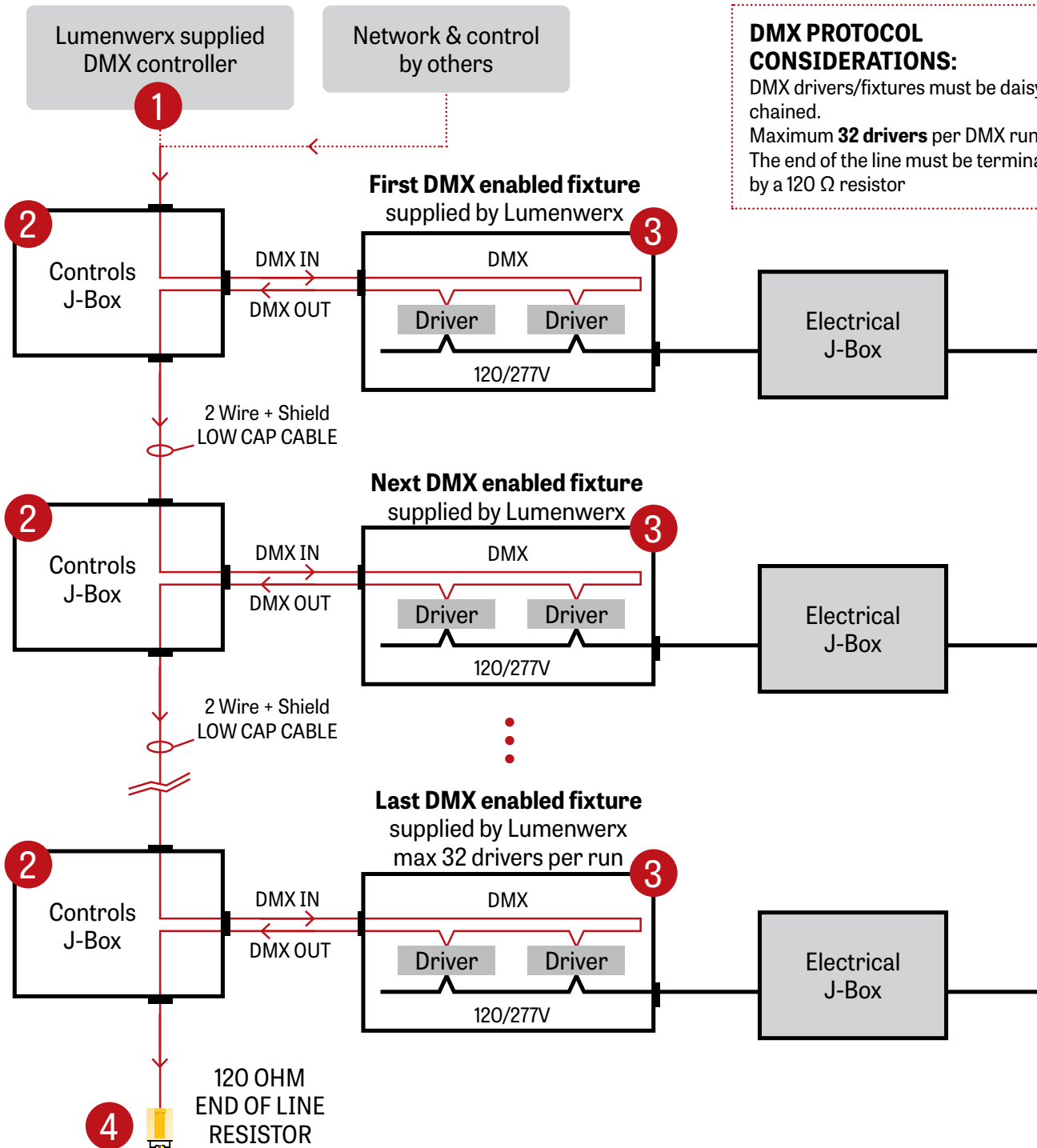

DMX PROTOCOL CONSIDERATIONS:
DMX drivers/fixtures must be daisy chained.
Maximum **32 drivers** per DMX run.
The end of the line must be terminated by a 120 Ω resistor

VIA 2 RECESSED PATTERN

DIRECT
CHROMAWERX - SOLA, DUO

1 LUMENWERX SUPPLIED DMX CONTROLLER

To the first fixture

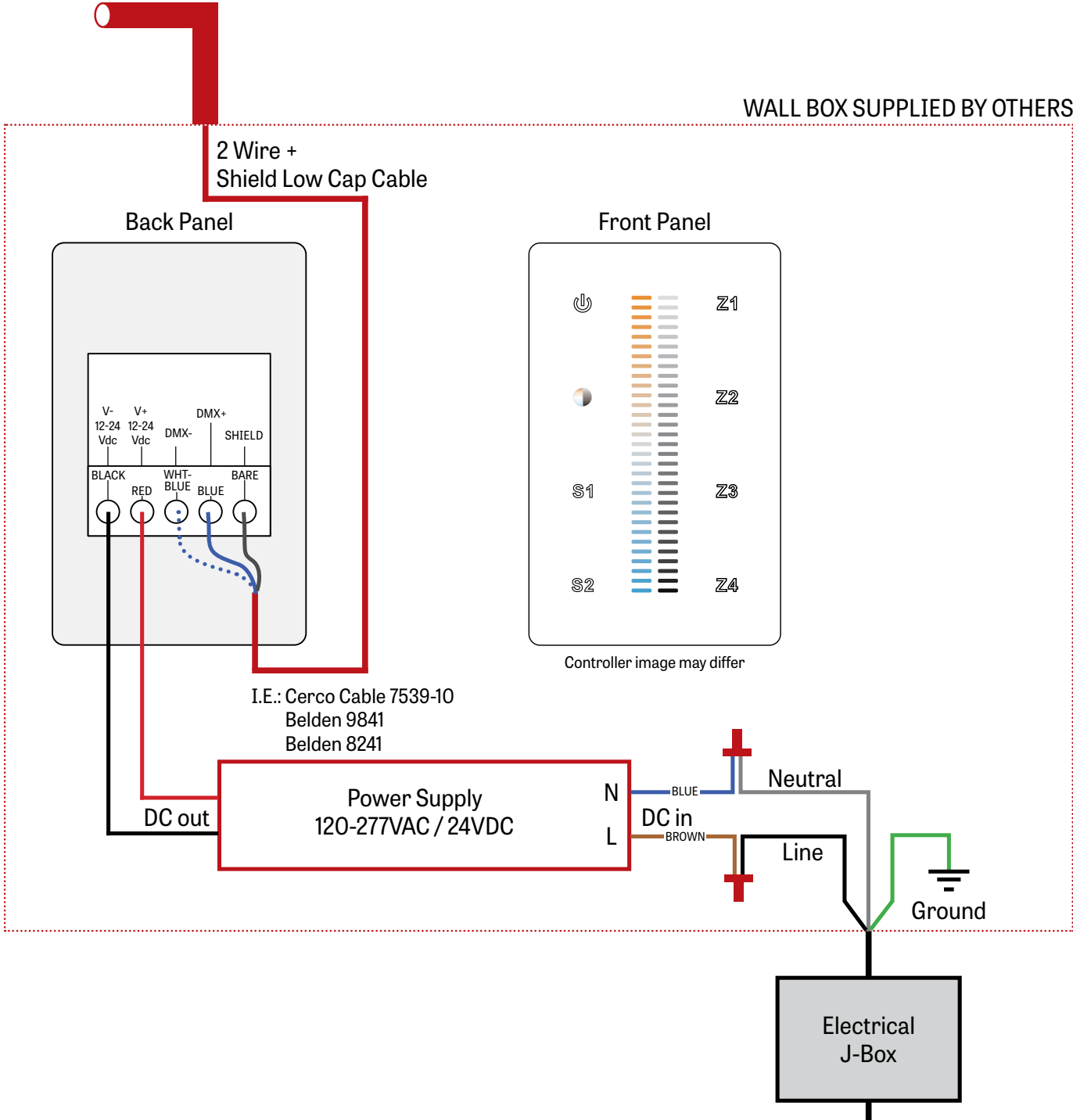

VIA 2 RECESSED PATTERN

DIRECT
CHROMAWERX - SOLA, DUO

2 J-BOX DMX DAISY CHAIN DETAIL

Low capacitance DMX Cable from Previous Fixture

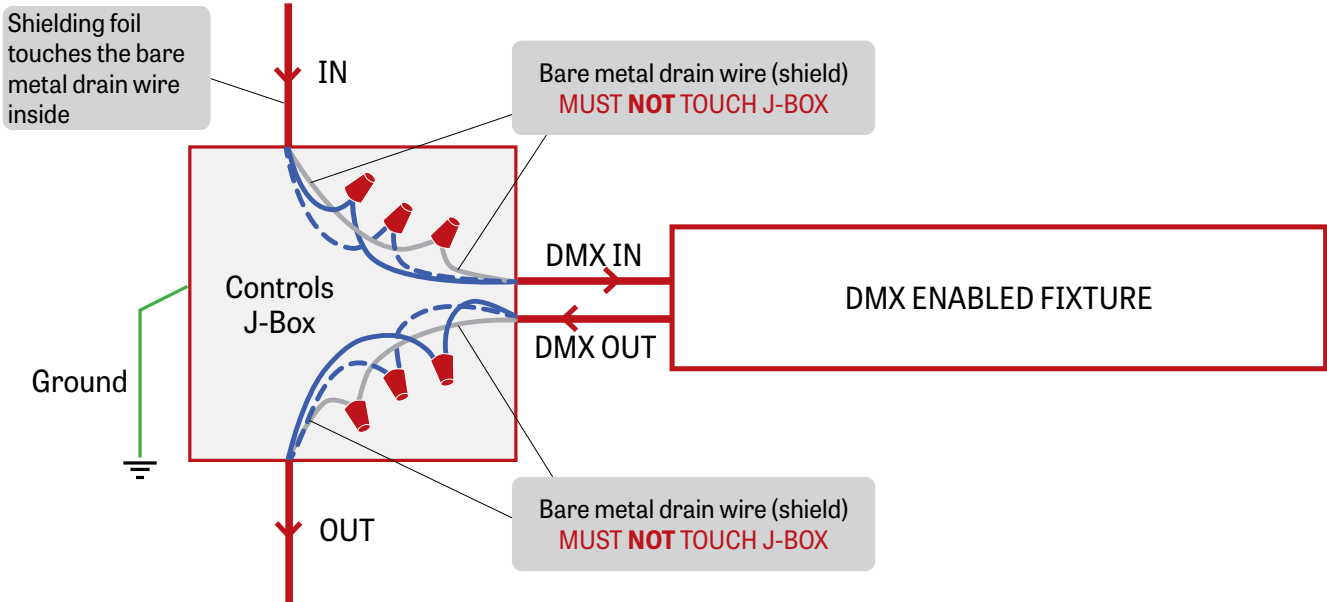

Low capacitance DMX cable to next fixture

3 DMX CONNECTION RECESSED & SURFACE

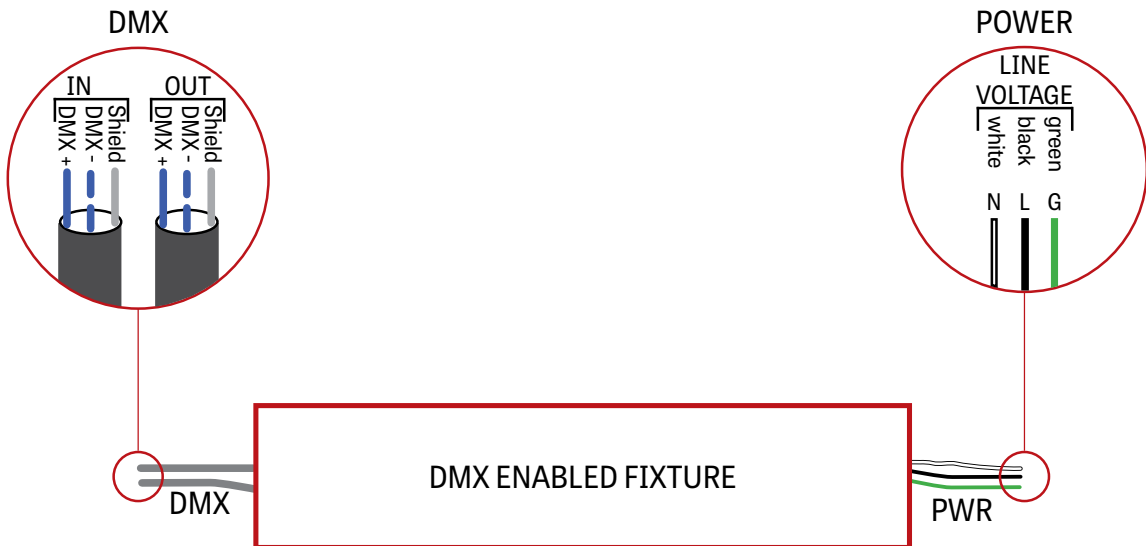

VIA 2 RECESSED PATTERN

DIRECT
CHROMAWERX - SOLA, DUO

4 DMX LAST FIXTURE DETAIL

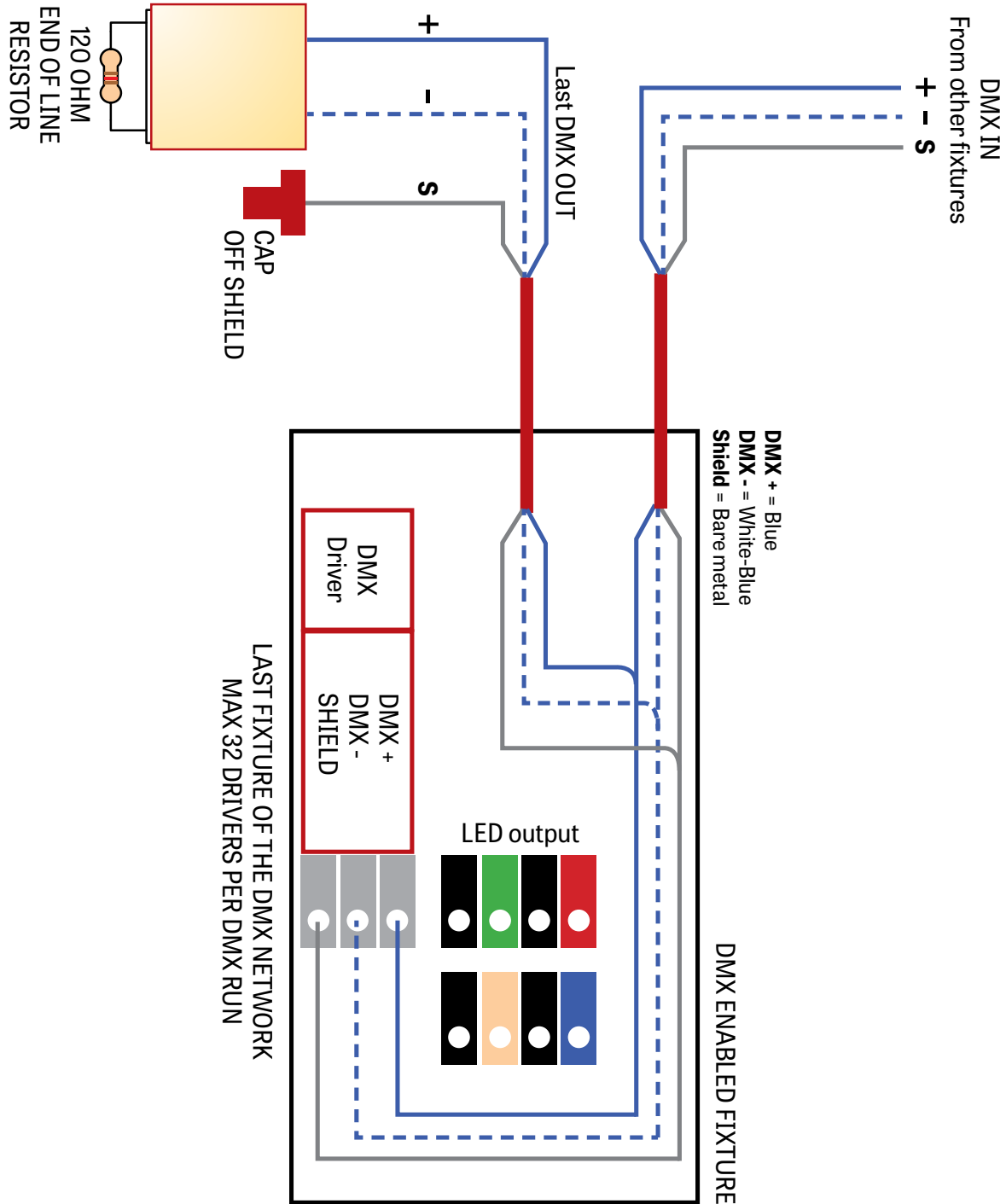

VIA 2 RECESSED PATTERN

DIRECT
CHROMAWERX - SOLA, DUO

DMX WALL CONTROLLER

DUO 1-4 ZONE

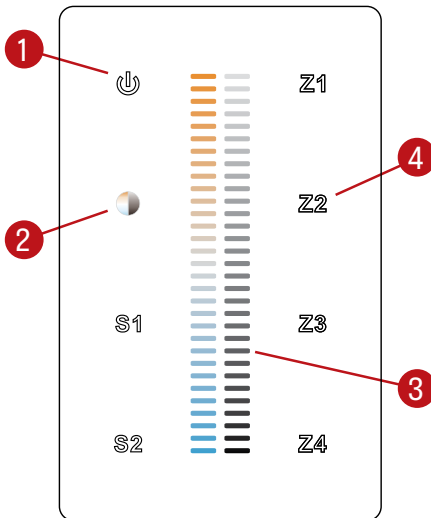

- (1) Power: Use this button to turn ON or OFF the fixture.
- (2) Brightness/CCT: Use the color/brightness toggle button to choose between color/brightness. When Blue: brightness is selected, when Yellow: color is selected.
- (3) Slider: Depending on the mode chosen in step 2, the slider will allow the user to set desired color or brightness.
- (4) Zone select: Up to 4 zones can be selected either independently or together. Once selected, the commands will be sent to the zone identified by a Blue LED.

Default DMX Addresses:

- 1 Warm
- 2 Cool

VIA 2 RECESSED PATTERN



DIRECT
CHROMAWERX - SOLA, DUO

DUAL 0-10V WALL CONTROLLER

Front Panel

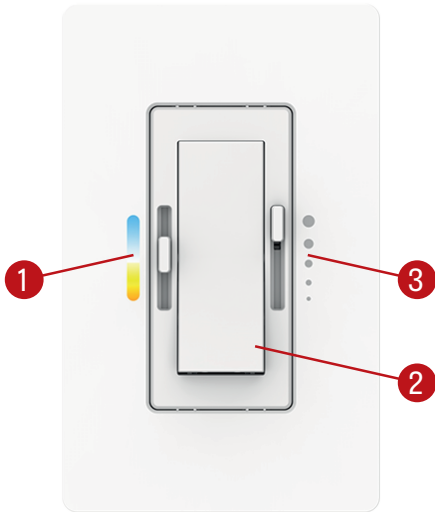

Controller image may differ

Dimensions

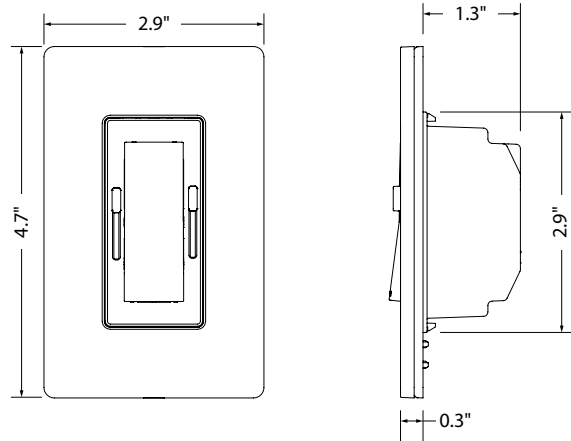

- (1) CCT control: Use this button to adjust the color temperature.
- (2) On/Off switch: Use this button to turn ON or OFF the fixture.
- (3) Dimming control: Use this button to adjust the brightness.

Wiring Diagram

