

VIA 2 SEAL

WALL PATTERN

STATIC WHITE, FULL SPECTRUM, BIOS

SEALWERX SERIES

 Lumenwerx

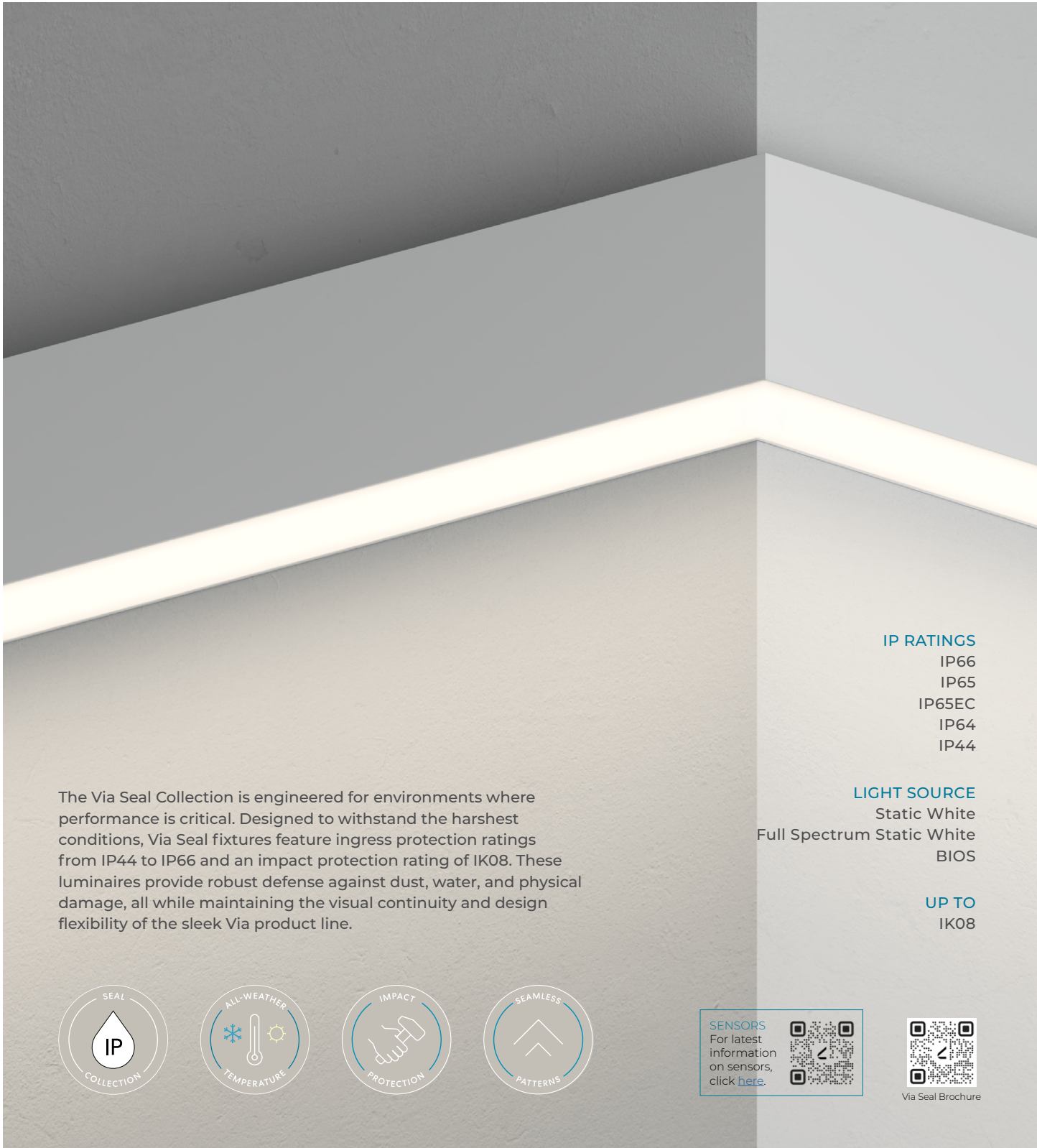

The Via Seal Collection is engineered for environments where performance is critical. Designed to withstand the harshest conditions, Via Seal fixtures feature ingress protection ratings from IP44 to IP66 and an impact protection rating of IK08. These luminaires provide robust defense against dust, water, and physical damage, all while maintaining the visual continuity and design flexibility of the sleek Via product line.

IP RATINGS

- IP66
- IP65
- IP65EC
- IP64
- IP44

LIGHT SOURCE

- Static White
- Full Spectrum Static White
- BIOS

UP TO

IK08

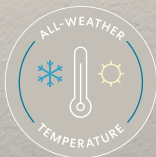

SENSORS
For latest information on sensors, click [here](#).



Via Seal Brochure

VIA 2 SEAL

WALL PATTERN

STATIC WHITE, FULL SPECTRUM, BIOS



Project: _____

Type: _____

SEALWERX SERIES

Order Guide

LUMINAIRE ID	DISTRIBUTION	ENVIRONMENT ¹	DIRECT OPTIC	INDIRECT OPTIC Specify NA for Direct fixture	LIGHT SOURCE ⁴	
V2SEALWPAT						
V2SEALWPAT - Via 2" Seal Wall Pattern	D - Direct DI - Direct/Indirect	<u>Direct:</u> IP66 - IP66-Rated IP65EC - IP65-Rated Electrical Components IP64 - IP64-Rated IP44 ² - IP44-Rated ¹ See page 5 to 6 for more information on the features and installation details for each environment option. ² Fixture must be installed with direct lens facing down.	<u>Direct/Indirect:</u> IP65 - IP65-Rated IP64 - IP64-Rated IP44 ² - IP44-Rated	EPDO - Environmentally Protected Direct Optic ASDO - Asymmetric Soft Direct Optic	EPIO - Environmentally Protected Indirect Optic ASIO ³ - Asymmetric Soft Indirect Optic NA - Not applicable ³ Not available with BIOS.	SW - Static white FS - Full spectrum static white BIOSST ⁵ - BIOS Biological Static BIOSDY ⁵ - BIOS Biological Dynamic BIOSTU ⁵ - BIOS Biological Tunable ⁴ Chromawerx SOLA and DUO also available. Consult factory for RGBW. ⁵ See page 9 for details.

CRI	DIR. LUM. PACK.	INDIR. LUM. PACK. Specify NA for Direct fixture	COLOR TEMP.	PATTERN LENGTH	CORNER TYPE ¹³
80CRI ⁶ - 80+ CRI 90CRI ^{6,7} - 90+ CRI 95CRI ⁸ - 95+ CRI ⁶ Not available with full spectrum. ⁷ Not available with BIOS. ⁸ Only available with full spectrum.	350LMF - Low output 350 lm/ft 500LMF - Medium output 500 lm/ft 750LMF ⁹ - High output 750 lm/ft ⁹ Not available with BIOS or full spectrum.	350LMF - Low output 350 lm/ft 500LMF - Medium output 500 lm/ft 750LMF ¹⁰ - High output 750 lm/ft NA - Not applicable ¹⁰ Not available with BIOS or full spectrum.	27K ¹¹ - 2700K 30K - 3000K 35K - 3500K 40K - 4000K 50K ¹¹ - 5000K ¹¹ Not available with BIOS.	##FT##IN(##X##FT##IN-##X##FT##IN-...) ¹² - ##FT##IN: total nominal length of pattern in feet and/or inches ##X: quantity of each section ##FT##IN: nominal length of each section in feet and/or inches Continuous runs: lengths over 12' ¹² - Minimum 2' for Direct. • Minimum 3' for Direct/Indirect. • Available in 2' increments only with BIOSTU/BIOSDY.	#LEVI2C(A##) - 2-way leveled inside corner #LEVO2C(A##) - 2-way leveled outside corner <u>ANGLE (A##):</u> (A90) - 90° (A##) ¹⁴ - Custom ¹³ Specify quantity (#) and angle (A##) for each required corner type. If more than one option is specified, separate codes with a "+", e.g. 1LEVI2C(A90)+2LEVO2C(A60). ¹⁴ Minimum angle is 45°.

VOLTAGE	DRIVER ¹⁶	ELECTRICAL	ELECTRICAL SECTIONS (optional) ^{27,26}
120V - 120V 277V - 277V UNV - 120V-277V 347V ¹⁵ - 347V ¹⁵ Available with DI driver only.	D1 - 1% 0-10V ELV ¹⁷ - ELV 120V TRI ¹⁷ - TRIAC 120V DA ¹⁸ - DALI LDE1 ¹⁸ - Lutron Hi-lume 1% Eco ELD1 - eldoLED 1% ECOdrive 0-10V ELDO - eldoLED 0.1% SOLOdrive 0-10V RLTD10 ¹⁹ - Low-temperature 10% 0-10V ¹⁶ See page 5 to 6 for driver temperature ranges. ¹⁷ Available with 120V only. ¹⁸ On-site commissioning is required. ¹⁹ Driver is remote. A remote driver box is provided.	1C - 1 circuit 2C ²⁰ - 2 circuits #MC ²¹ - Multi circuit EC - Emergency-powered fixture NL - Night light fixture DL - Daylight fixture GTD ^{22,23,24} - Generator transfer device fixture ²⁰ Available for Direct/Indirect only. Separate direct and indirect circuits. ²¹ Specify total number of circuits (#), including any circuits required for electrical section options. Provide drawing or layout specifications. Minimum 4' section per circuit. ²² Minimum 4' fixture. ²³ Not available with 347V. ²⁴ Not available for environments where the ambient temperature falls below 0°C (32°F).	#EC## ²⁷ - Emergency-powered section #NL## ²⁷ - Night light section #DL## ²⁷ - Daylight section #GTD## ^{27,28,29,30} - Generator transfer device section #EMB ^{29,30,31,32} - Emergency battery NA - None ²⁷ Specify with multi circuit (#MC) electrical option only. ²⁸ Provide drawing or layout specifications. Consult factory for other configurations. Default section length is 4'. ²⁹ Specify quantity (#), and section length in inches (##). ²⁸ Minimum 4' section. ²⁹ Not available with 347V. ³⁰ Not available for environments where the ambient temperature falls below 0°C (32°F). ³¹ Specify quantity (#). All batteries will be on the same circuit. Each battery powers a 4' section. For Direct/Indirect, minimum 8' fixture. ³² Only available with IP64 and IP44.

POWER FEED	MOUNTING	FINISH	OPTION
BF - Back feed EF - End feed	HMB - Horizontal mounting bracket MMB - Mullion mounting bracket	W - Matte white AL - Aluminum B - Matte black WA - White antimicrobial Silverwerx CF# - Custom finish, specify RAL#	CRF ³³ - Corrosion-resistant finish NATA ³³ - Natatorium finish MAR ³³ - Marine finish NA - None ³³ Only available with IP66, IP65 and IP65EC environment option.



VIA 2 SEAL

WALL PATTERN

STATIC WHITE, FULL SPECTRUM, BIOS

SEALWERX SERIES



Pattern Layout

CORNER TYPES

LEVELED INSIDE CORNER

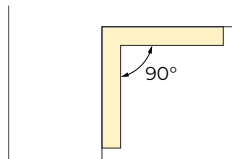

1LEVI2C(A90)

LEVELED OUTSIDE CORNER

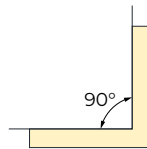

1LEVO2C(A90)

2-way

EXAMPLES

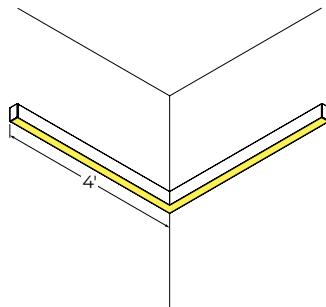

8FT(2X4FT)-1LEVI2C(A90)

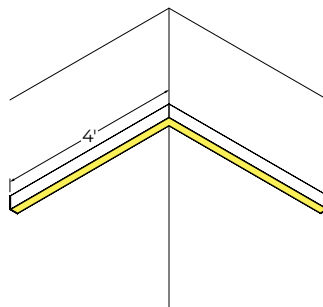

8FT(2X4FT)-1LEVO2C(A90)

VIA 2 SEAL

WALL PATTERN

STATIC WHITE, FULL SPECTRUM, BIOS



SEALWERX SERIES

Dimensions

DIRECT

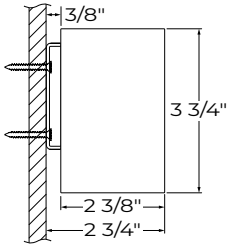

HMB - Horizontal mounting bracket

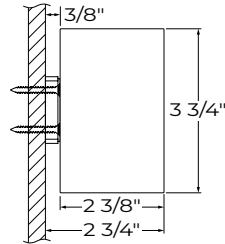

MMB - Mullion mounting bracket

DIRECT/INDIRECT

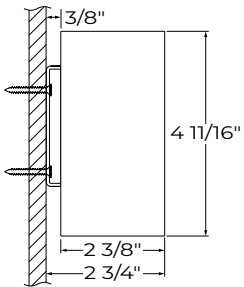

HMB - Horizontal mounting bracket

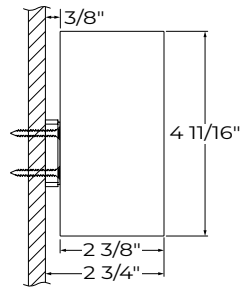

MMB - Mullion mounting bracket

VIA 2 SEAL

WALL PATTERN

STATIC WHITE, FULL SPECTRUM, BIOS



SEALWERX SERIES

Environment Options

Direct			
IP66	IP65EC <small>Electrical Components</small>	IP64	IP44
Dust tight High water resistance	Dust tight Moderate water resistance	Dust tight Water splash resistance	Particles larger than 1mm protected Water splash resistance
OUTDOOR			
Directly exposed to the elements	Moderate exposure to the elements	Under canopy, slightly exposed	Under canopy, not exposed
INDOOR			
Wipe down application Healthcare application Cleanroom application	Wipe down application Healthcare application		
<p>external end cap gasket</p>		<p>internal end cap gasket</p>	
External joiner gasket every 12'	Continuous line of light over 12'	External joiner gasket every 12'	Continuous line of light over 12'
Driver: in a sealed enclosure Electrical connections: water and dust proof			
LED boards: conformal coated for maximum protection			
Protective finish options: Corrosion-resistant, Natatorium and Marine			

Ambient Temperature Range

based on driver selection

	LDE1	ELV / TRI	DA / ELD1 / ELDO	D1	RLTD10
Minimum temperature:	0 °C / 32 °F	-10 °C / 14 °F	-20 °C / -4 °F	-30 °C / -22 °F	-40 °C / -40 °F
Maximum temperature:	40 °C / 104 °F				



VIA 2 SEAL

WALL PATTERN

STATIC WHITE, FULL SPECTRUM, BIOS



SEALWERX SERIES

Environment Options

Direct/Indirect		
IP65	IP64	IP44
Dust tight Moderate water resistance	Dust tight Water splash resistance	Particles larger than 1mm protected Water splash resistance
Moderate exposure to the elements	OUTDOOR Under canopy, slightly exposed	Under canopy, not exposed
Wipe down application Healthcare application Cleanroom application	INDOOR Wipe down application Healthcare application	
External joiner gasket every 12' 	Continuous line of light over 12' 	
Driver: in a sealed enclosure Electrical connections: water and dust proof		
LED boards: conformal coated for maximum protection		
Protective finish options: Corrosion-resistant, Natatorium and Marine		

Ambient Temperature Range

based on driver selection

	LDE1	ELV / TRI	DA / ELD1 / ELD0	D1	RLTD10
Minimum temperature:	0 °C / 32 °F	-10 °C / 14 °F	-20 °C / -4 °F	-30 °C / -22 °F	-40 °C / -40 °F
Maximum temperature:	40 °C / 104 °F				

3737 Cote Vertu St-Laurent, Quebec, Canada H4R 2C9
T (514) 225-4304 F (514) 931-4862
www.Lumenwerx.com



Lumenwerx reserves the right to modify product specifications without notification.
© Lumenwerx, ULC. All rights reserved.
VIA2SEAL-PAT-WALL-SPEC-REV6 January 14, 2026

VIA 2 SEAL

WALL PATTERN

STATIC WHITE, FULL SPECTRUM, BIOS



SEALWERX SERIES

Photometrics

Values calculated based on a 4' fixture at 3500K for all optics.

DIRECT

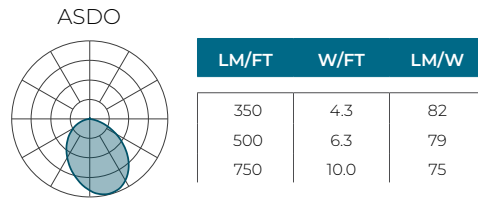
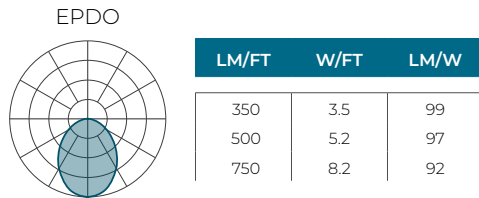

MULTIPLIERS

Use this table to get results for different color temperatures for all photometric tables.

CCT	WATTS		LPW
	80+ CRI / 90+ CRI	80+ CRI / 90+ CRI	80+ CRI / 90+ CRI
2700K	1.05		0.95
3000K	1.02		0.98
3500K	1.00		1.00
4000K	1.00		1.00
5000K	0.96		1.04

VIA 2 SEAL

WALL PATTERN

STATIC WHITE, FULL SPECTRUM, BIOS



SEALWERX SERIES

Photometrics

Values calculated based on a 4' fixture at 3500K for all optics.

DIRECT/INDIRECT

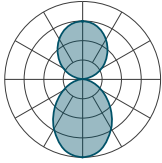

EPDO - EPIO

		LM/FT		W/FT	LM/W
		D	I		
EPDO	EPIO				
350	350	700	7.0	100	
	500	850	8.7	98	
	750	1100	11.7	94	
500	350	850	8.7	98	
	500	1000	10.3	97	
	750	1250	13.3	94	
750	350	1100	11.7	94	
	500	1250	13.3	94	
	750	1500	16.3	92	

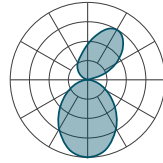

EPDO - ASIO

		LM/FT		W/FT	LM/W
		D	I		
EPDO	ASIO				
350	350	700	6.9	102	
	500	850	8.5	100	
	750	1100	11.3	97	
500	350	850	8.5	100	
	500	1000	10.1	99	
	750	1250	13.0	96	
750	350	1100	11.6	95	
	500	1250	13.2	95	
	750	1500	16.0	94	

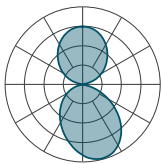

ASDO - EPIO

		LM/FT		W/FT	LM/W
		D	I		
ASDO	EPIO				
350	350	700	7.8	90	
	500	850	9.4	90	
	750	1100	12.4	89	
500	350	850	9.8	87	
	500	1000	11.5	87	
	750	1250	14.5	86	
750	350	1100	13.6	81	
	500	1250	15.2	82	
	750	1500	18.1	83	

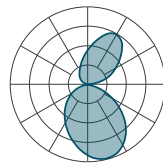

ASDO - ASIO

		LM/FT		W/FT	LM/W
		D	I		
ASDO	ASIO				
350	350	700	7.6	92	
	500	850	9.2	92	
	750	1100	12.1	91	
500	350	850	9.7	88	
	500	1000	11.2	89	
	750	1250	14.2	88	
750	350	1100	13.4	82	
	500	1250	15.1	83	
	750	1500	17.9	84	

MULTIPLIERS

Use this table to get results for different color temperatures for all photometric tables.

CCT	WATTS		LPW	
	80+ CRI / 90+ CRI		80+ CRI / 90+ CRI	
2700K	1.05		0.95	
3000K	1.02		0.98	
3500K	1.00		1.00	
4000K	1.00		1.00	
5000K	0.96		1.04	

VIA 2 SEAL

WALL PATTERN

STATIC WHITE, FULL SPECTRUM, BIOS

SEALWERX SERIES



BIOS

Three BIOS Circadian LED solutions are offered – Biological Static, Biological Dynamic, and Biological Tunable. Use the decision tree below to identify when and where to use BIOS Wellness LED Lighting Solutions.

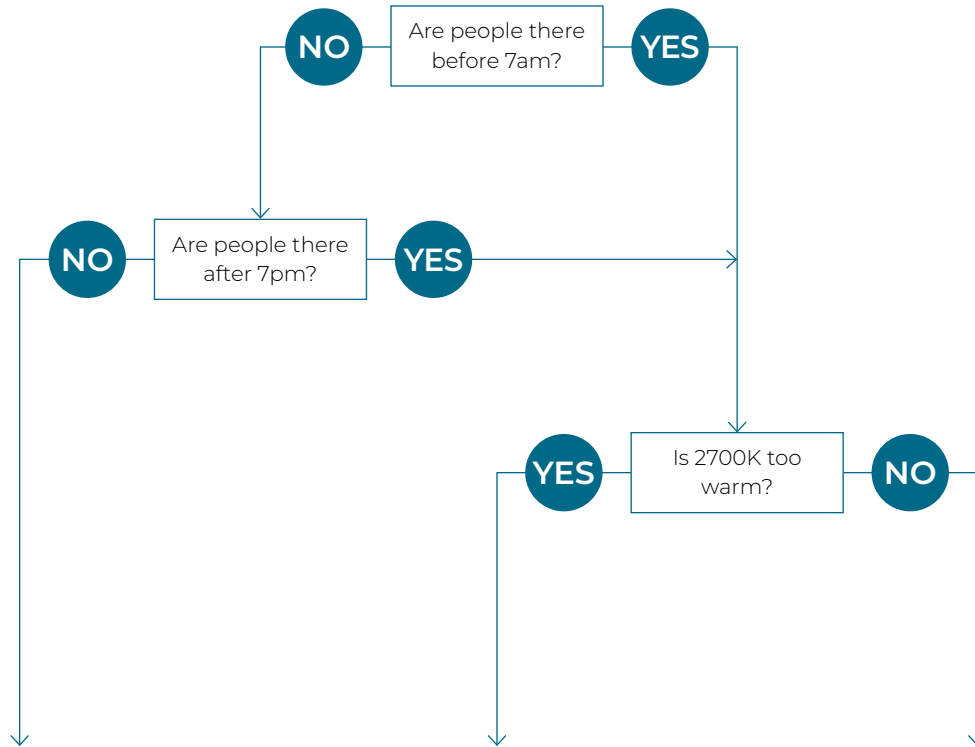

Biological Static BIOSST	Biological Dynamic BIOSDY	Biological Tunable BIOSTU
No CCT change when dimmed	500K shift when dimmed	Dims to 2700K
Daytime solution	Daytime + evening solution	Daytime + evening solution
Spaces in operation during daytime hours, between 7am and 7pm	Spaces in operation overnight, after 7pm and before 7am, and when CCT color shift in the evening is not preferred	Suitable for spaces in operation overnight, after 7pm and before 7am, and where people do not sleep (CCT color shift in the evening is preferred)
E.g. offices, medical/dental offices	E.g. hospitals	E.g. offices, shiftwork

VIA 2 SEAL

WALL PATTERN

STATIC WHITE, FULL SPECTRUM, BIOS

SEALWERX SERIES



Technical Specifications

DIRECT OPTICS

Environmentally Protected Direct Optic (EPDO)

The Environmentally Protected Direct Optic creates a seal that blocks debris and moisture, and withstands UV distortion and moderate impact. This extruded snap-in lens has a gasket to ensure proper sealing. The lens is 1/16" thick and made of frosted polycarbonate. Internally, white, side kicking reflectors guide the light through the lens. The EPDO suits moderate climate environments.

Asymmetric Soft Direct Optic (ASDO)

The Asymmetric Soft Direct Optic creates a seal that blocks debris and moisture, and withstands UV distortion and moderate impact. This extruded snap-in lens has a gasket to ensure proper sealing. The lens is 1/16" thick and made of frosted polycarbonate. Internally, white, side kicking reflectors specifically angled to guide the light through the lens to create a nice asymmetric distribution. The ASDO suits moderate climate environments.

INDIRECT OPTICS

Environmentally Protected Indirect Optic (EPIO)

The Environmentally Protected Indirect Optic creates a seal that blocks debris and moisture, and withstands UV distortion and moderate impact. The lens is 1/16" thick and made of frosted polycarbonate. This extruded snap-in lens has a gasket to ensure proper sealing. The EPIO suits moderate climate environments.

Asymmetric Soft Indirect Optic (ASIO)

The Asymmetric Soft Indirect Optic creates a seal that blocks debris and moisture, and withstands UV distortion and moderate impact. The lens is 1/16" thick and made of clear polycarbonate. This extruded snap-in lens has a gasket to ensure proper sealing. The total internal reflection and surface scattering optic is specifically angled to guide the light through the lens to create a nice asymmetric distribution. The ASIO suits moderate climate environments.

LIGHT SOURCE

Static white

Custom linear array of mid-flux LEDs are cartridge-mounted with quick-connect wiring to facilitate service and thermal management. Available in 2700K, 3000K, 3500K, 4000K, and 5000K with a minimum 80+ CRI and an option for 90+ CRI with elevated R9 value. Color consistency maintained to within 3 SDCM. All LEDs have been tested in accordance with IESNA LM-80-08 and the results have shown L80 lumen maintenance greater than 60,000 hours. Absolute product photometry is measured and presented in accordance with IESNA LM-79, unless otherwise indicated.

Full spectrum static white

The full spectrum LED option offers improved color particularly in the cyan region that is beneficial in both healthcare and circadian lighting strategies. The cyan region in full spectrum LED is richer at the 480 nm range.

BIOS

BIOS SkyBlue™ Technology is designed to provide the specific circadian stimulus to improve overall sleep quality, recovery during the night, and overall feelings of well-being. The non-visual light signals that stimulate our circadian system have peak intensity in the "sky blue" region. As the diagram below illustrates, BIOS SkyBlue technology shifts the peak LED spectral intensity (490 nm) to align better with the peak response of circadian stimulus. Also note the enhanced deep-red (near 660 nm) spectrum.

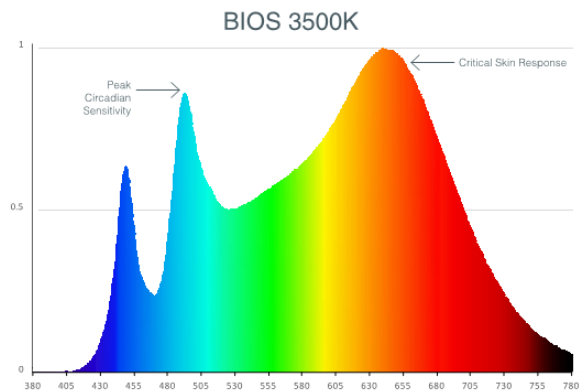

Three BIOS solutions are offered: BIOS Biological Static (BIOSST), BIOS Biological Dynamic (BIOSDY), and BIOS Biological Tunable (BIOSTU). See page 9 for details.

VIA 2 SEAL

WALL PATTERN

STATIC WHITE, FULL SPECTRUM, BIOS



SEALWERX SERIES

WELL BUILDING STANDARD



WELL for Light: The WELL building standard focuses on light quality in several features. There are three categories that are fully attributed to the construction and features of a luminaire. In WELL V1, it's Feature 54 Circadian Lighting, Feature 55 Glare Control, and Feature 58 Color Quality. In WELL V2, it's Feature L03 Circadian Lighting, Feature L04 Glare Control, and Feature L07 Electric Light Quality.

This fixture meets Features:

- Feature 54 or L03 when BIOS LED is selected
- Feature 58 or L07 when 90+ CRI is selected

All LED drivers used at Lumenwerx are deemed to have a low risk level of flicker, of 5% or less below 90Hz operational as defined by IEEE standard 1789-2015 LED.



WELL for Mind: This luminaire meets WELL for mind as it is a human centric luminaire offering quality light, excellent color, and smooth optics. If any of these features are incorporated in a luminaire, it can improve the ability to focus, concentrate, and persist longer on a given task. This fixture harmoniously operates in a space to assist the mind.

For more information, please contact well@lumenwerx.com

PATTERN LENGTH

Via 2 Seal can be ordered in 1' and/or 1" increments. Continuous runs are available for run lengths over 12'. The minimum length is 2' for Direct fixtures, and 3' for Direct/Indirect fixtures. All individual sections are joined together onsite using the joiner kits provided. Lumenwerx joiner kits are extremely simple to work with in the field and result in a fixture that appears virtually seamless with no light leak at any connection.

WEEP HOLES

The Direct/Indirect fixtures, with the IP44-Rated option, feature a weep hole situated in the end cap. Water and moisture that enters the fixture will be expelled through this hole.



TEMPERATURE VARIATION PROTECTION

Fixtures with the IP66-Rated, IP65-Rated, IP65-Rated Electrical Components and IP64-Rated environment options feature an integrated pressure equalization and moisture control GORE® protective vent. It allows air to flow while blocking water, dust, and contaminants. It also reduces internal condensation, supports thermal stability, and preserves the fixture's sealed performance over time.



Location may vary.

ELECTRICAL

Factory-set, adjustable output current LED driver with universal (120-277 VAC) input. Dimmable from 100% to 1% with 0-10V dimming control. Rated life (90% survivorship) of 50,000 hours at 50°C max. ambient (and 70°C max. case) temperature. At maximum driver load: Efficiency > 84%, PF > 0.9, THD < 20%. Other specifiable options include Lutron Hi-Lume 1% Ecosystem, eldoLED 1% ECOdrive 0-10V, eldoLED 0.1% SOLOdrive 0-10V, ELV, TRIAC, and DALI protocol drivers. All of our standard 0-10V drivers are NEMA 410 compliant. An optional low-temperature 10% 0-10V driver, suitable for temperatures down to -40°C/F is also available. ELV and TRIAC dimming performance (including minimum dimming percentage) subject to dimmer selection.

PoE

Depending on the PoE manufacturer selected, Lumenwerx will install the node in factory as either integral to the luminaire or as a remote module. Factory programming of the PoE node may or may not enable the following functionalities: lumen package, DUO (tunable white), QUADRO (RGBW), emergency battery backup, and sensor integration. These must be addressed and evaluated on a case-by-case basis.

ELECTRICAL SECTION OPTIONS

Electrical section options are available for fixtures specified as multi circuit (#MC). With MC, specify the total number of circuits (#), including any circuits required for optional electrical sections. A drawing is required to specify the layout. Please consult factory for custom configurations.

VIA 2 SEAL

WALL PATTERN

STATIC WHITE, FULL SPECTRUM, BIOS



SEALWERX SERIES

Electrical sections

Options include emergency-powered light (#EC##), night light (#NL##), daylight (#DL##), and generator transfer device (#GTD##) sections. Specify the quantity (#), as well as the section length in inches (##).

Example 1: A 32' Direct fixture with two 8' emergency light sections on a second circuit.
Code: 2MC-2EC96

Example 2: A 16' Direct/Indirect fixture with separate circuits for direct and indirect, and with one 4' night light section on the direct side on a third circuit.
Code: 3MC-1NL48

Example 3: A 24' Direct fixture with one 4' generator transfer device section.
Code: 1MC-1GTD48

Battery

Each emergency battery (#EMB) powers a 4' section. All batteries will be on the same circuit. Specify the number of batteries (#) required.
Factory installed long life, high temperature, maintenance-free Lithium-Ion battery pack with self-test functionality, test switch and charge indicator. Minimum of 90 minutes operation, up to 1000 lumens per 4' (25°C) emergency lighting output and recharge time of 24 hours. Suited for ambient temperatures of 0°C (32°F) to 55°C (131°F).

Generator Transfer Device (GTD)

A UL924 listed shunt relay that can bypass both line voltage (120-277V) and 0-10V dimming signal. Suited for ambient temperatures of 0°C (32°F) to 60°C (140°F).

MOUNTING

Fixtures may be horizontally mounted to either a wall or a mullion using a bracket. For long runs, a minimum of 6" from adjacent wall is required.

FINISH

Interior: 95%, reflective matte powder coated white paint
Exterior: Powder-coat paint in matte white, matte black, or aluminum. Custom finishes are also available. Optional antimicrobial finish.

FINISH OPTIONS

Corrosion-resistant: General protection from moisture, humidity, cleaners, and mild chemicals

Natatorium: Protection from chlorine vapour, high humidity, and condensation

Marine: Protection from salt spray, air, and UV

CONSTRUCTION

Housing: Extruded aluminum, up to 90% recycled content

Interior brackets: Die-formed cold rolled sheet steel

Gaskets: Closed-cell silicone foam

Reflectors: Die-formed cold rolled sheet steel, 95% reflective matte white painted

End cap: Die-cast aluminum

Horizontal mounting bracket: Steel bracket with stainless steel PEM studs and sealing washers

Mullion mounting bracket: Die-cast aluminum

CERTIFICATIONS

ETL: IP44-Rated environment option is rated for dry/damp locations. IP66-Rated, IP65-Rated, IP65-Rated Electrical Components and IP64-Rated environment options are ETL Wet Listed. Conforms to UL Standard 1598 and certified to CAN/CSA Standard C22.2 No. 250.0. During the installation of Wet Listed fixtures, the contractor is responsible for properly sealing all mounting and electrical connection points.

IK08: Impact resistance rated to IK08

WARRANTY

Lumenwerx provides a five-year limited warranty on electrical and mechanical performance of the luminaires, including the LED boards, drivers, and auxiliary electronics. Lumenwerx will repair or replace defective luminaires or components at our discretion, provided they have been installed and operated in accordance with our specifications. Other limitations apply, please refer to the full warranty on our website.