

VIA 2 SEAL

WALL

CHROMAWERX - SOLA, DUO

SEALWERX SERIES

 Lumenwerx

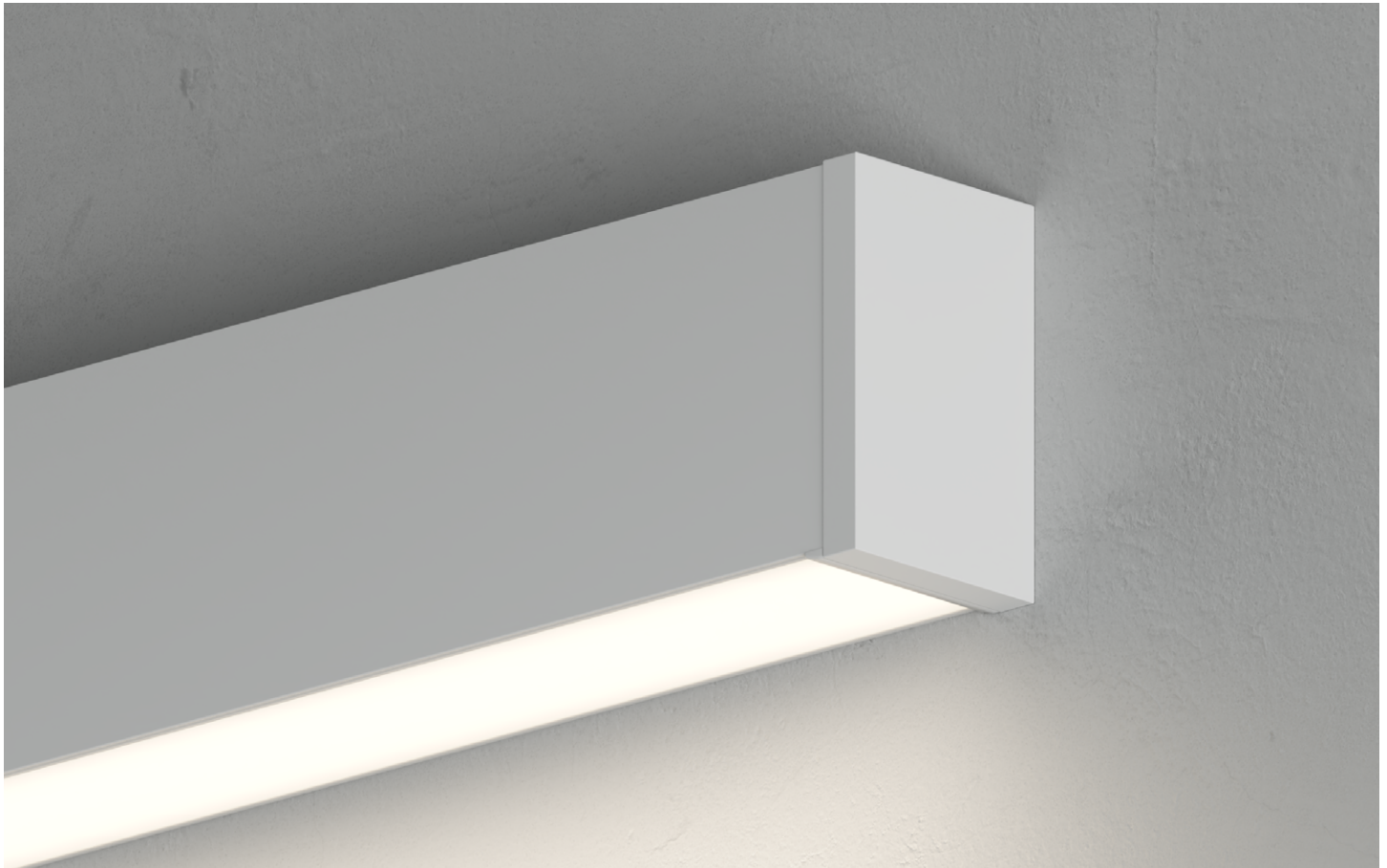

The Via Seal Collection is engineered for environments where performance is critical. Designed to withstand the harshest conditions, Via Seal fixtures feature ingress protection ratings from IP44 to IP66 and an impact protection rating of IK08. These luminaires provide robust defense against dust, water, and physical damage, all while maintaining the visual continuity and design flexibility of the sleek Via product line.

IP RATINGS

- IP66
- IP65
- IP65EC
- IP64
- IP44

LIGHT SOURCE

- SOLA - Dim-to-Warm
- DUO - Tunable White

UP TO

IK08

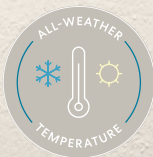

SENSORS
For latest information on sensors, click [here](#).



Via Seal Brochure



VIA 2 SEAL

WALL

CHROMAWERX - SOLA, DUO



Project: _____

Type: _____

SEALWERX SERIES

Order Guide

LUMINAIRE ID	DISTRIBUTION	ENVIRONMENT ¹	DIRECT OPTIC	INDIRECT OPTIC Specify NA for Direct fixture	LIGHT SOURCE ³	CRI	
V2SEALW							
V2SEALW - Via 2" Seal Wall	D - Direct DI - Direct/ Indirect	<u>Direct:</u> IP66 - IP66-Rated IP65EC - IP65-Rated Electrical Components IP64 - IP64-Rated IP44 ² - IP44-Rated ¹ See page 4 to 5 for more information on the features and installation details for each environment option. ² Fixture must be installed with direct lens facing down.	<u>Direct/Indirect:</u> IP65 - IP65-Rated IP64 - IP64-Rated IP44 ² - IP44- Rated	EPDO - Environmentally Protected Direct Optic ASDO - Asymmetric Soft Direct Optic	EPIO - Environmentally Protected Indirect Optic ASIO - Asymmetric Soft Indirect Optic NA - Not applicable	SOLA - Dim-to-warm single channel control 35K to 22K DUO - Tunable white 2-channel control 65K to 27K ³ Static white and BIOS also available. Consult factory for RGBW.	80CRI - 80+ CRI 90CRI - 90+ CRI

DIRECT LUMEN PACKAGE	INDIRECT LUMEN PACKAGE Specify NA for Direct fixture	LUMINAIRE LENGTH	VOLTAGE	DRIVER ⁵	ELECTRICAL
					1C
350LMF - Low output 350 lm/ft 500LMF - Medium output 500 lm/ft 750LMF - High output 750 lm/ft	350LMF - Low output 350 lm/ft 500LMF - Medium output 500 lm/ft 750LMF - High output 750 lm/ft NA - Not applicable	#FT#IN ⁴ - Specify nominal length (#) in 1' and/or 1" increments Standard nominal lengths: Single units: 2' to 12' Continuous runs: lengths over 12' ⁴ - Minimum 2' for Direct. - Minimum 3' for Direct/Indirect. - Minimum 4' for DMX.	120V - 120V 277V - 277V UNV - 120V-277V	<u>SOLA</u> SDI - Single 0-10V input <u>DUO</u> DMX ^{6,7} - DMX DDA ⁷ - DALI DT6 DDA8 ⁷ - DALI DT8 DD1 - Dual 0-10V input for CCT/intensity LD2 ⁷ - Lutron DALI-2 digital ⁵ See page 4 to 5 for driver temperature ranges. ⁶ For more information, see pages 11 to 16. ⁷ On-site commissioning is required.	1C - 1 circuit

POWER FEED	MOUNTING	FINISH	OPTION
BF - Back feed EF - End feed	HMB - Horizontal mounting bracket MMB - Mullion mounting bracket	W - Matte white AL - Aluminum B - Matte black WA - White antimicrobial Silverwerx CF# - Custom finish, specify RAL#	CRF ⁸ - Corrosion-resistant finish NATA ⁸ - Natatorium finish MAR ⁸ - Marine finish NA - None ⁸ Only available with IP66, IP65 and IP65EC environment options.

Accessories

Optional, order separately

WALL CONTROLLER ⁹	
DMX	DD1
WCW##FT ¹⁰ - DMX wall controller white WCB##FT ¹⁰ - DMX wall controller black	TWCW##FT ¹¹ - Dual 0-10V wall controller white TWCB##FT ¹¹ - Dual 0-10V wall controller black
⁹ Specify wire length (##) in feet. ¹⁰ Available with DMX only. For more information, see pages 11 to 16, or consult factory. ¹¹ Available with DD1 only. For more information, see page 17, or consult factory.	



VIA 2 SEAL

WALL

CHROMAWERX - SOLA, DUO



SEALWERX SERIES

Dimensions

DIRECT

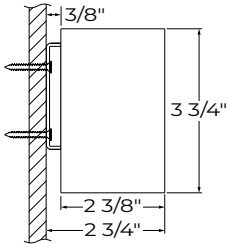

HMB - Horizontal mounting bracket

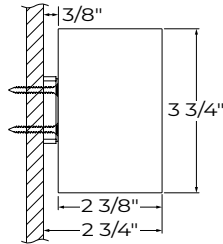

MMB - Mullion mounting bracket

DIRECT/INDIRECT

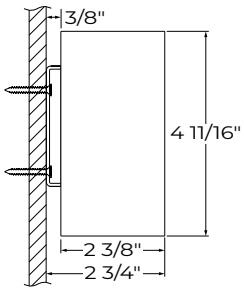

HMB - Horizontal mounting bracket

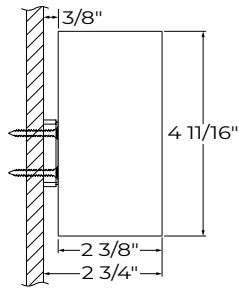

MMB - Mullion mounting bracket

VIA 2 SEAL

WALL

CHROMAWERX - SOLA, DUO



SEALWERX SERIES

Environment Options

Direct			
IP66	IP65EC <small>Electrical Components</small>	IP64	IP44
Dust tight High water resistance	Dust tight Moderate water resistance	Dust tight Water splash resistance	Particles larger than 1mm protected Water splash resistance
OUTDOOR			
Directly exposed to the elements	Moderate exposure to the elements	Under canopy, slightly exposed	Under canopy, not exposed
INDOOR			
Wipe down application Healthcare application Cleanroom application	Wipe down application Healthcare application		
<p>external end cap gasket</p>		<p>internal end cap gasket</p>	
External joiner gasket every 12'	Continuous line of light over 12'	External joiner gasket every 12'	Continuous line of light over 12'
Driver: in a sealed enclosure Electrical connections: water and dust proof			
LED boards: conformal coated for maximum protection			
Protective finish options: Corrosion-resistant, Natatorium and Marine			

Ambient Temperature Range

based on driver selection

	LD2	SD1 / DMX / DDA / DDA8	DD1
Minimum temperature:	0 °C / 32 °F	-20 °C / -4 °F	-25 °C / -13 °F
Maximum temperature:		40 °C / 104 °F	



VIA 2 SEAL

WALL

CHROMAWERX - SOLA, DUO



SEALWERX SERIES

Environment Options

Direct/Indirect		
IP65	IP64	IP44
Dust tight Moderate water resistance	Dust tight Water splash resistance	Particles larger than 1mm protected Water splash resistance
Moderate exposure to the elements	OUTDOOR Under canopy, slightly exposed	Under canopy, not exposed
Wipe down application Healthcare application Cleanroom application	INDOOR Wipe down application Healthcare application	
External joiner gasket every 12'	Continuous line of light over 12'	
Driver: in a sealed enclosure Electrical connections: water and dust proof		
LED boards: conformal coated for maximum protection		
Protective finish options: Corrosion-resistant, Natatorium and Marine		

Ambient Temperature Range

based on driver selection

	LD2	SD1 / DMX / DDA / DDA8	DD1
Minimum temperature:	0 °C / 32 °F	-20 °C / -4 °F	-25 °C / -13 °F
Maximum temperature:		40 °C / 104 °F	

3737 Cote Vertu St-Laurent, Quebec, Canada H4R 2C9
T (514) 225-4304 F (514) 931-4862
www.Lumenwerx.com



Lumenwerx reserves the right to modify product specifications without notification.
© Lumenwerx, ULC. All rights reserved.
VIA2SEAL-WALL-TW-SPEC-REV6 January 14, 2026

VIA 2 SEAL

WALL

CHROMAWERX - SOLA, DUO



SEALWERX SERIES

Photometrics

Values calculated based on a 4' fixture at 3500K for all optics.

DIRECT

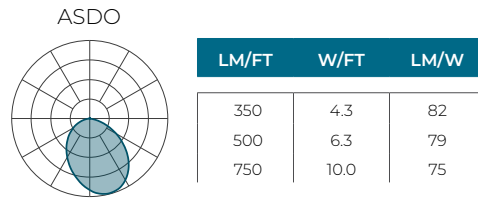
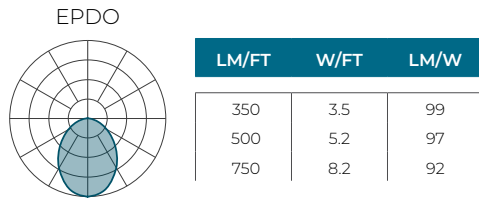

MULTIPLIERS

Use these tables to get results for different color temperatures for all photometric tables.

SOLA

CCT	WATTS	LPW
	80+ CRI / 90+ CRI	80+ CRI / 90+ CRI
3500K	1.00	1.00

DUO

CCT	WATTS	LPW
	80+ CRI / 90+ CRI	80+ CRI / 90+ CRI
2700K	1.05	0.95
6500K	1.00	1.00

VIA 2 SEAL

WALL

CHROMAWERX - SOLA, DUO



SEALWERX SERIES

Photometrics

Values calculated based on a 4' fixture at 3500K for all optics.

DIRECT/INDIRECT

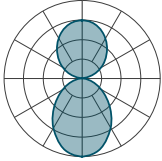

EPDO - EPIO

LM/FT		TOTAL LM/FT	W/FT	LM/W
D	I			

EPDO	EPIO			
	350	700	7.0	100
350	500	850	8.7	98
	750	1100	11.7	94
500	350	850	8.7	98
	500	1000	10.3	97
	750	1250	13.3	94
750	350	1100	11.7	94
	500	1250	13.3	94
	750	1500	16.3	92

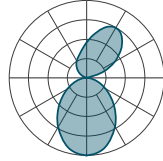

EPDO - ASIO

LM/FT		TOTAL LM/FT	W/FT	LM/W
D	I			

EPDO	ASIO			
	350	700	6.9	102
350	500	850	8.5	100
	750	1100	11.3	97
500	350	850	8.5	100
	500	1000	10.1	99
	750	1250	13.0	96
750	350	1100	11.6	95
	500	1250	13.2	95
	750	1500	16.0	94

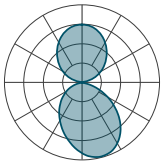

ASDO - EPIO

LM/FT		TOTAL LM/FT	W/FT	LM/W
D	I			

ASDO	EPIO			
	350	700	7.8	90
350	500	850	9.4	90
	750	1100	12.4	89
500	350	850	9.8	87
	500	1000	11.5	87
	750	1250	14.5	86
750	350	1100	13.6	81
	500	1250	15.2	82
	750	1500	18.1	83

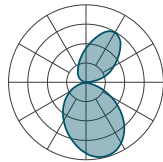

ASDO - ASIO

LM/FT		TOTAL LM/FT	W/FT	LM/W
D	I			

ASDO	ASIO			
	350	700	7.6	92
350	500	850	9.2	92
	750	1100	12.1	91
500	350	850	9.7	88
	500	1000	11.2	89
	750	1250	14.2	88
750	350	1100	13.4	82
	500	1250	15.1	83
	750	1500	17.9	84

MULTIPLIERS

Use these tables to get results for different color temperatures for all photometric tables.

SOLA

CCT	WATTS		LPW
	80+ CRI / 90+ CRI		80+ CRI / 90+ CRI

3500K	1.00	1.00
-------	------	------

DUO

CCT	WATTS		LPW
	80+ CRI / 90+ CRI		80+ CRI / 90+ CRI

2700K	1.05	0.95
6500K	1.00	1.00



VIA 2 SEAL

WALL

CHROMAWERX - SOLA, DUO



SEALWERX SERIES

Technical Specifications

DIRECT OPTICS

Environmentally Protected Direct Optic (EPDO)

The Environmentally Protected Direct Optic creates a seal that blocks debris and moisture, and withstands UV distortion and moderate impact. This extruded snap-in lens has a gasket to ensure proper sealing. The lens is 1/16" thick and made of frosted polycarbonate. Internally, white, side kicking reflectors guide the light through the lens. The EPDO suits moderate climate environments.

Asymmetric Soft Direct Optic (ASDO)

The Asymmetric Soft Direct Optic creates a seal that blocks debris and moisture, and withstands UV distortion and moderate impact. This extruded snap-in lens has a gasket to ensure proper sealing. The lens is 1/16" thick and made of frosted polycarbonate. Internally, white, side kicking reflectors specifically angled to guide the light through the lens to create a nice asymmetric distribution. The ASDO suits moderate climate environments.

INDIRECT OPTICS

Environmentally Protected Indirect Optic (EPIO)

The Environmentally Protected Indirect Optic creates a seal that blocks debris and moisture, and withstands UV distortion and moderate impact. The lens is 1/16" thick and made of frosted polycarbonate. This extruded snap-in lens has a gasket to ensure proper sealing. The EPIO suits moderate climate environments.

Asymmetric Soft Indirect Optic (ASIO)

The Asymmetric Soft Indirect Optic creates a seal that blocks debris and moisture, and withstands UV distortion and moderate impact. The lens is 1/16" thick and made of clear polycarbonate. This extruded snap-in lens has a gasket to ensure proper sealing. The total internal reflection and surface scattering optic is specifically angled to guide the light through the lens to create a nice asymmetric distribution. The ASIO suits moderate climate environments.

LIGHT SOURCE

Custom linear array of alternating color temperature mid-flux LEDs are mounted directly to the housing for optimal thermal performance. For the DUO products, a color temperature range from 6500K-2700K is achievable with color points on or below the black body curve. For the SOLA products, a color temperature range from 3500K-2200K is controlled synchronously with intensity. Color consistency between fixtures is maintained to within 3 SDCM. All LEDs have been tested in accordance with IESNA LM-80-08 and the results have shown L80 lumen maintenance greater than 60,000 hours. Absolute product photometry is measured and presented in accordance with IESNA LM-79, unless otherwise indicated.

Chromawerx SOLA

It is a single-channel control that dims output while warming the color temperature in a pre-determined relationship. A simple analog control sends a common signal to dual output digital drivers, which are programmed to adjust a specially populated LED array to emulate the effect of dimming a filament source. Dimming range is programmable but the default option runs from 3500K at 100% of full power to 2200K at 5% of full power. CRI is maintained above 80 throughout the dimming range.

Chromawerx DUO

It is a two-channel control. It uses an analog (0-10V) protocol for separate control of luminaire CCT and intensity or a digital (DMX, DALI, and LD2) protocol for synchronous control of both warm and cool LED arrays to enable the user to set color temperature and light output. Commonly called "tunable white", Chromawerx two-channel control provides the range of cool (6500K) to warm (2700K) color that can be useful for helping to entrain circadian rhythms, stimulate alertness for improved educational and work productivity, and compensate for jet lag, among other applications. The Chromawerx drivers are programmed to limit maximum light output and power usage across all color temperatures. CRI is maintained above 80. When paired with DALI drivers (DDA/DDA8), color tuning follows a linear dimming curve.

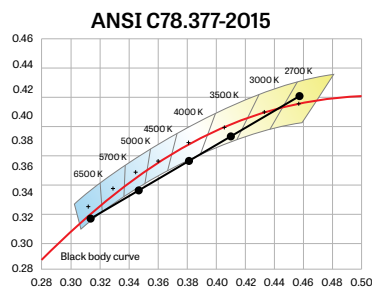

VIA 2 SEAL

WALL

CHROMAWERX - SOLA, DUO



SEALWERX SERIES

WELL BUILDING STANDARD



WELL for Light: The WELL building standard focuses on light quality in several features. There are three categories that are fully attributed to the construction and features of a luminaire. In WELL V1, it's Feature 54 Circadian Lighting, Feature 55 Glare Control, and Feature 58 Color Quality. In WELL V2, it's Feature L03 Circadian Lighting, Feature L04 Glare Control, and Feature L07 Electric Light Quality.

This fixture meets Features:

- Feature 54 or L03 when DUO is selected
- Feature 58 or L07 when 90+ CRI is selected

All LED drivers used at Lumenwerx are deemed to have a low risk level of flicker, of 5% or less below 90Hz operational as defined by IEEE standard 1789-2015 LED.



WELL for Mind: This luminaire meets WELL for mind as it is a human centric luminaire offering quality light, excellent color, and smooth optics. If any of these features are incorporated in a luminaire, it can improve the ability to focus, concentrate, and persist longer on a given task. This fixture harmoniously operates in a space to assist the mind.

For more information, please contact well@lumenwerx.com

LUMINAIRE LENGTH

Via 2 Seal is available in standard lengths of 2' to 12'. Continuous runs are available for run lengths over 12'. Exact run length must be noted in the product code. The minimum length is 2' for Direct fixtures, and 3' for Direct/Indirect fixtures. Lengths can be ordered in 1' and/or 1" increments. All individual sections are joined together onsite using the joiner kits provided. Lumenwerx joiner kits are extremely simple to work with in the field and result in a fixture that appears virtually seamless with no light leak at any connection.

WEEP HOLES

The Direct/Indirect fixtures, with the IP44-Rated option, feature a weep hole situated in the end cap. Water and moisture that enters the fixture will be expelled through this hole.



TEMPERATURE VARIATION PROTECTION

Fixtures with the IP66-Rated, IP65-Rated, IP65-Rated Electrical Components and IP64-Rated environment options feature an integrated pressure equalization and moisture control GORE® protective vent. It allows air to flow while blocking water, dust, and contaminants. It also reduces internal condensation, supports thermal stability, and preserves the fixture's sealed performance over time.



Location may vary.

ELECTRICAL

SOLA

SDI

Factory-set, adjustable output current LED driver with universal (120-277 VAC) input. Using a single 0-10V control signal, the light output warms in color temperature as it dims down to 1% and 2200K. At maximum driver load, efficiency<86%, PF>0.9, THD<20%.

DUO

DMX

Factory-set adjustable output current electronic driver with 120-277 VAC line input. Using DMX wall controls (optionally supplied by Lumenwerx) or an existing DMX control system, both channels of LEDs are independently adjustable. Each DMX driver can be independently addressed using the built-in RDM (Remote Device Management) in the field. Dimming down to 1% is attainable. Rated life (90% survivorship) of 50,000 hours at 50°C maximum ambient temperature. At maximum driver load, efficiency<84%, PF>0.9, THD<20%.

DALI

Factory-set adjustable output current electronic driver with 120-277 VAC line input. Using an existing DALI control system (supplied by others), one control channel adjusts the fixture color temperature, and the other control channel adjusts fixture brightness. With DALI Type 6, two DALI addresses are required to control both channels. With DALI Type 8, one DALI address is required to control both channels. Dimming down to 1% is attainable. Rated life (90% survivorship) of 50,000 hours at 50°C maximum ambient temperature. At maximum driver load, efficiency<84%, PF>0.9, THD<20%.

VIA 2 SEAL

WALL

CHROMAWERX - SOLA, DUO



SEALWERX SERIES

DD1

Factory-set adjustable output current LED driver with universal (120-277 VAC) input. Controlled via two individual 0-10V signals, one for setting light output down to a minimum of 1% and the other for adjusting the CCT (default range of 6500K-2700K). Rated life of 50,000 hours at 70°C maximum driver case temperature and 100% load conditions. Typical efficiency of 86%, PF>0.9, THD<20% at 100% load conditions.

LD2

Lutron DALI-2 digital drivers provide a high-performance tunable white solution with single-address digital control. Guaranteed performance and compatibility when used with Lutron DALI-2 controls.

PoE

Depending on the PoE manufacturer selected, Lumenwerx will install the node in factory as either integral to the luminaire or as a remote module. Factory programming of the PoE node may or may not enable the following functionalities: lumen package, DUO (tunable white), QUADRO (RGBW), emergency battery backup, and sensor integration. These must be addressed and evaluated on a case-by-case basis.

MOUNTING

Fixtures may be horizontally mounted to either a wall or a mullion using a bracket. For long runs, a minimum of 6" from adjacent wall is required.

FINISH

Interior: 95%, reflective matte powder coated white paint

Exterior: Powder-coat paint in matte white, matte black, or aluminum. Custom finishes are also available. Optional antimicrobial finish.

FINISH OPTIONS

Corrosion-resistant: General protection from moisture, humidity, cleaners, and mild chemicals

Natatorium: Protection from chlorine vapour, high humidity, and condensation

Marine: Protection from salt spray, air, and UV

CONSTRUCTION

Housing: Extruded aluminum, up to 90% recycled content

Interior brackets: Die-formed cold rolled sheet steel

Gaskets: Closed-cell silicone foam

Reflectors: Die-formed cold rolled sheet steel, 95% reflective matte white painted

End cap: Die-cast aluminum

Horizontal mounting bracket: Steel bracket with stainless steel PEM studs and sealing washers

Mullion mounting bracket: Die-cast aluminum

WEIGHT

Direct	Direct/Indirect
4': 9.0 lbs - 4.1 kg	4': 12.1 lbs - 5.5 kg
8': 18.3 lbs - 8.3 kg	8': 23.3 lbs - 10.6 kg
12': 28 lbs - 12.7 kg	12': 34.6 lbs - 15.7 kg

CERTIFICATIONS

ETL: IP44-Rated environment option is rated for dry/damp locations. IP66-Rated, IP65-Rated, IP65-Rated Electrical Components and IP64-Rated environment options are ETL Wet Listed. Conforms to UL Standard 1598 and certified to CAN/CSA Standard C22.2 No. 250.0. During the installation of Wet Listed fixtures, the contractor is responsible for properly sealing all mounting and electrical connection points.

IK08: Impact resistance rated to IK08

WARRANTY

Lumenwerx provides a five-year limited warranty on electrical and mechanical performance of the luminaires, including the LED boards, drivers, and auxiliary electronics. Lumenwerx will repair or replace defective luminaires or components at our discretion, provided they have been installed and operated in accordance with our specifications. Other limitations apply, please refer to the full warranty on our website.

Wall controllers are covered by the manufacturer warranty.

VIA 2 SEAL

WALL

CHROMAWERX - SOLA, DUO

SEALWERX SERIES



DUO DMX SPECIFICATION

A qualified DMX integrator is required to assure proper installation and commissioning of the DMX network. **When placing the PO, please provide the contact information of your DMX integrator.**

Please answer the following questions to help us identify your DMX network requirements.

YES

Do you require a wall controller provided by Lumenwerx?

NO

DMX controller supplied by Lumenwerx

DMX control system supplied by others. Lumenwerx will supply DMX-enabled fixtures with default DMX addressing. See following pages for technical DMX informations. ✓

How many zones do you have?

A zone consists of one or more luminaires behaving identically.



1 Zone



2 Zones

How to calculate the required number of drivers:

per 4' fixture

Driver

1x driver

Direct only

per 4' fixture

Driver

Driver

2x driver

Direct high output

To Calculate # of drivers

1 - 4 Zones

5 or more Zones

Do you have more than 32 drivers in total?

NO

YES

Order a standard Lumenwerx wall controller.

WALL CONTROLLER

WCW - wall controller white
WCB - wall controller black

Add the control code at the end of your order code.

Please provide a fixture layout or RCP (Reflected Ceiling Plan) showing the locations of the DMX fixtures, zones and the DMX wall controller.

Refer to your DMX integrator for the installation. ✓

Subject to factory evaluation. Please contact our controls specialist at controls@lumenwerx.com. Additional cost and equipment will be required. ✓

Subject to factory evaluation and approval. Please contact our controls specialist at controls@lumenwerx.com. Additional cost and equipment will be required. ✓

VIA 2 SEAL

WALL

CHROMAWERX - SOLA, DUO

SEALWERX SERIES



GENERIC DMX NETWORK ARCHITECTURE

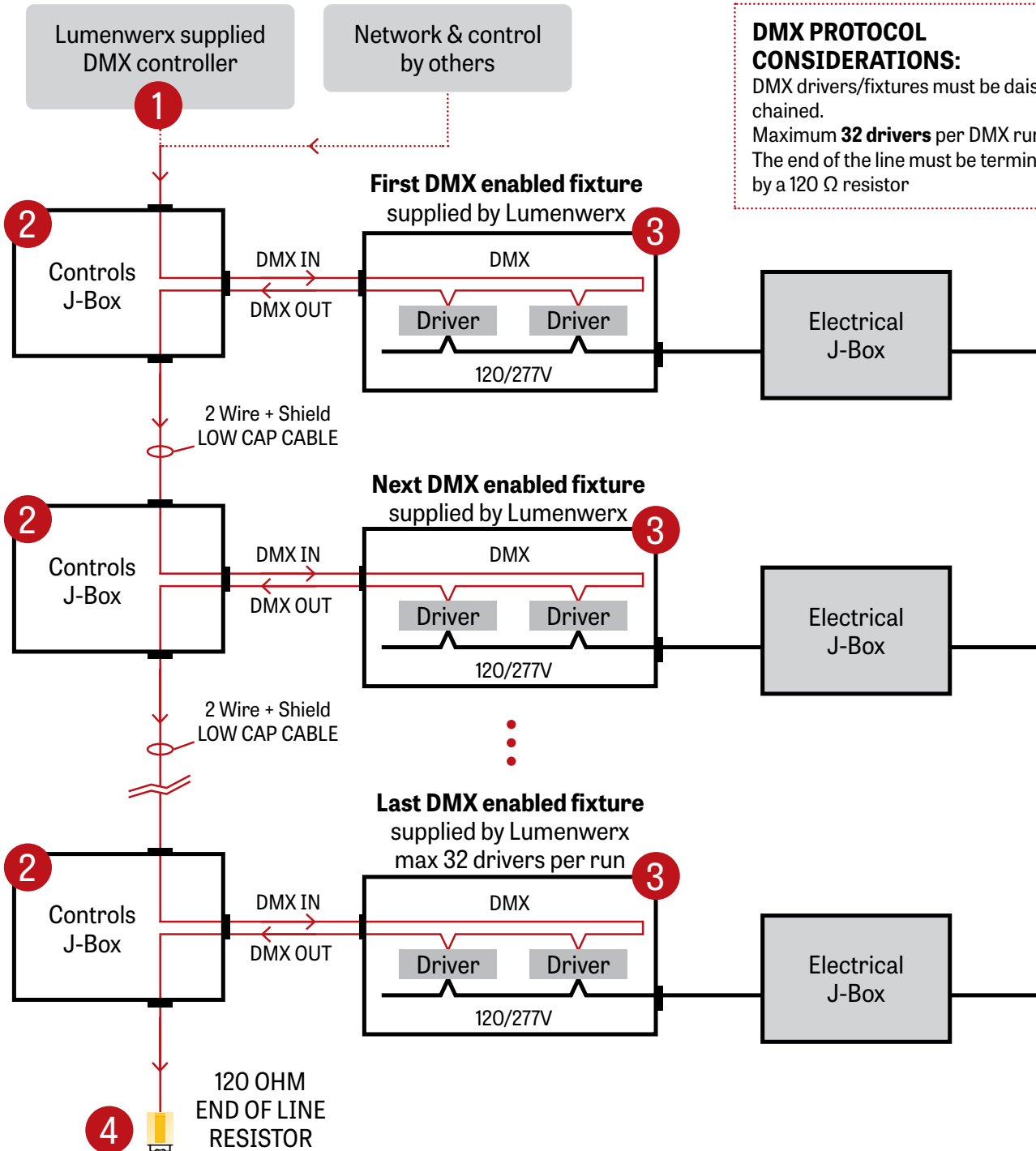

DMX PROTOCOL CONSIDERATIONS:

DMX drivers/fixtures must be daisy chained.
 Maximum **32 drivers** per DMX run.
 The end of the line must be terminated by a 120 Ω resistor

VIA 2 SEAL

WALL

CHROMAWERX - SOLA, DUO

SEALWERX SERIES



1 LUMENWERX SUPPLIED DMX CONTROLLER

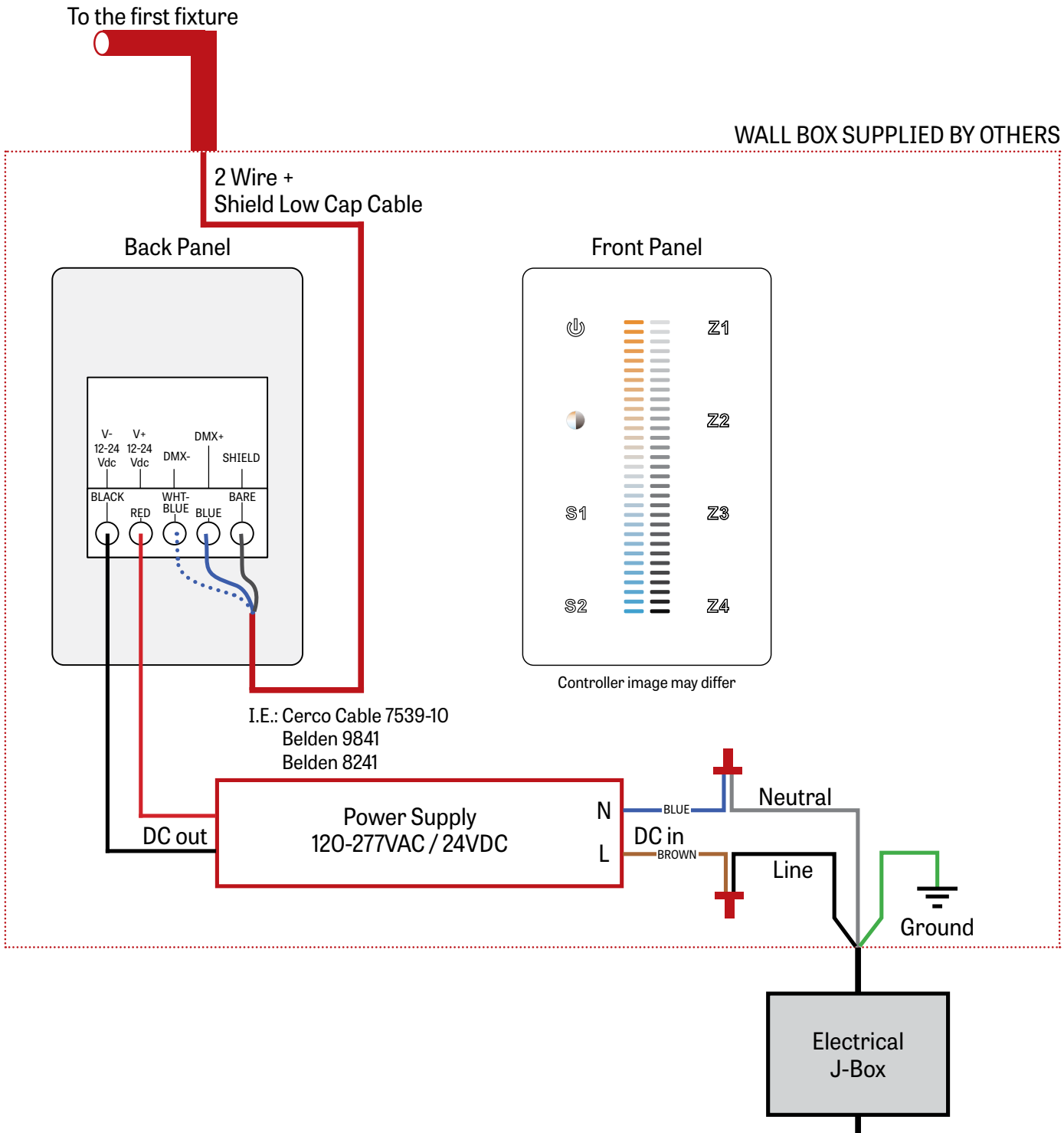

VIA 2 SEAL

WALL

CHROMAWERX - SOLA, DUO

SEALWERX SERIES



2 J-BOX DMX DAISY CHAIN DETAIL

Low capacitance DMX Cable from Previous Fixture

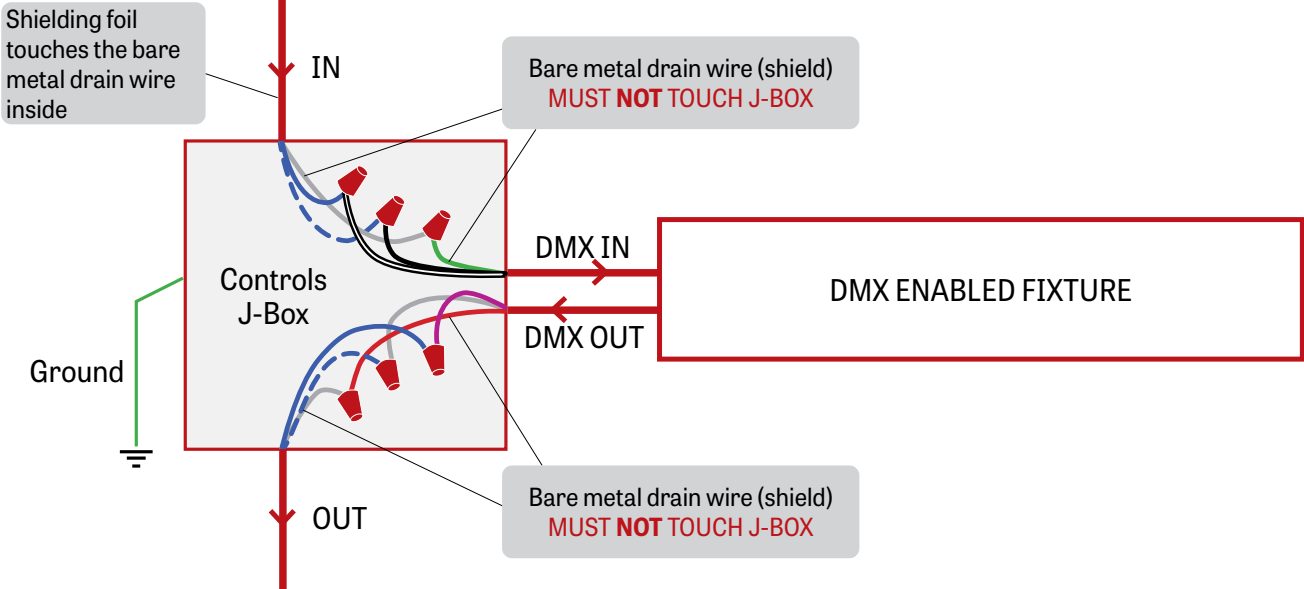

Low capacitance DMX cable to next fixture

3 DMX CONNECTION PENDANT & WALL

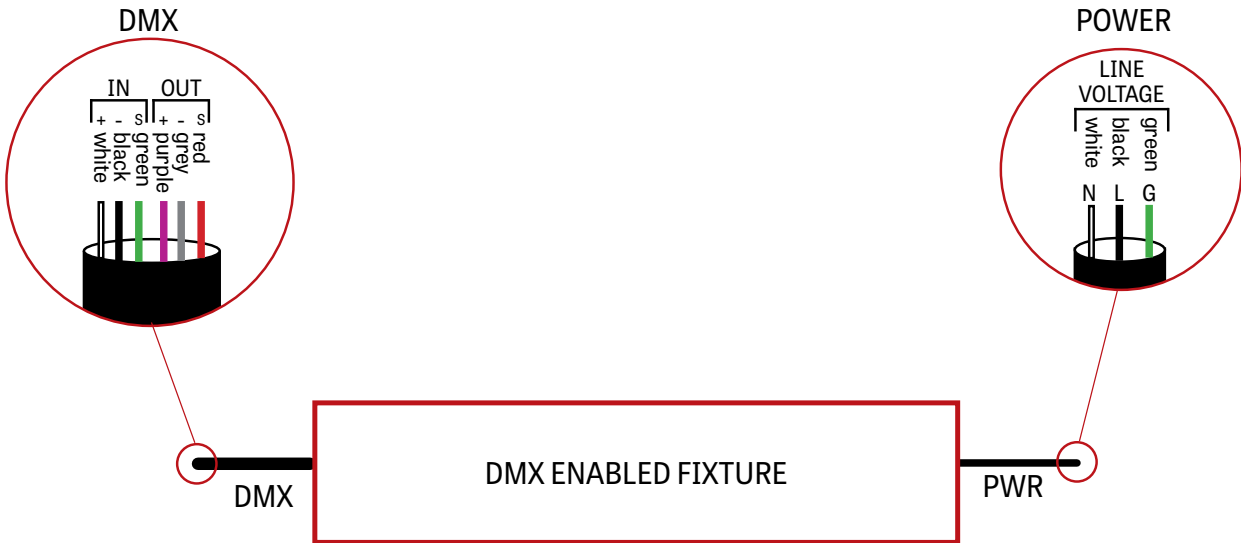

VIA 2 SEAL

WALL

CHROMAWERX - SOLA, DUO

SEALWERX SERIES



4 DMX LAST FIXTURE DETAIL

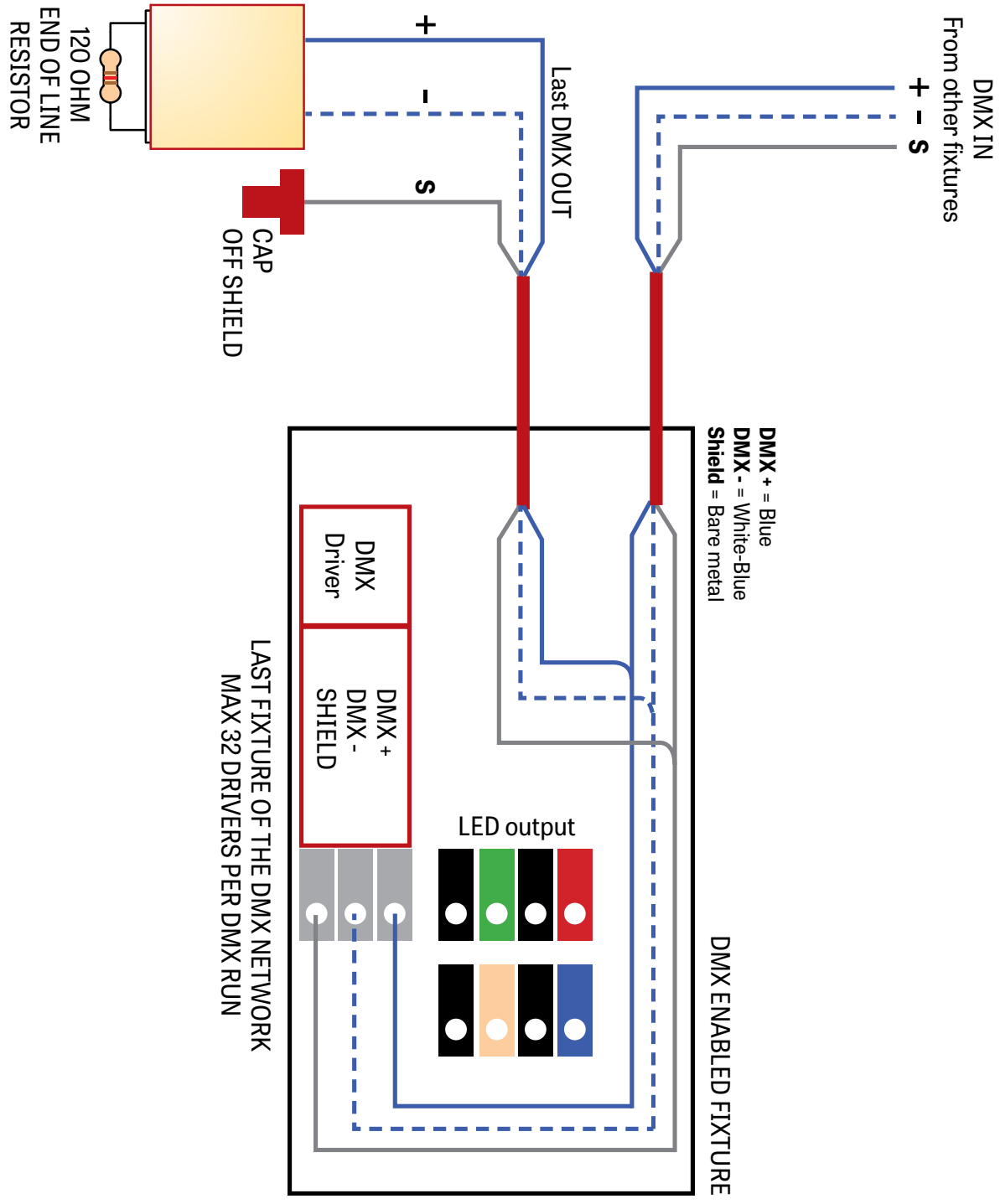

VIA 2 SEAL

WALL

CHROMAWERX - SOLA, DUO



SEALWERX SERIES

DMX WALL CONTROLLER

DUO 1-4 ZONE

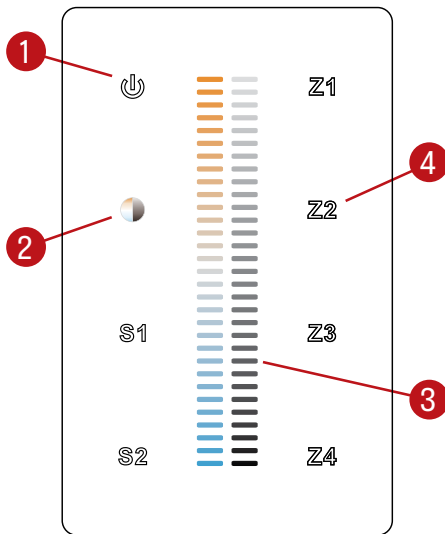

- (1) Power: Use this button to turn ON or OFF the fixture.
- (2) Brightness/CCT: Use the color/brightness toggle button to choose between color/brightness. When Blue: brightness is selected, when Yellow: color is selected.
- (3) Slider: Depending on the mode chosen in step 2, the slider will allow the user to set desired color or brightness.
- (4) Zone select: Up to 4 zones can be selected either independently or together. Once selected, the commands will be sent to the zone identified by a Blue LED.

Default DMX Addresses:

- 1 Warm
- 2 Cool

VIA 2 SEAL

WALL

CHROMAWERX - SOLA, DUO

SEALWERX SERIES



DUAL 0-10V WALL CONTROLLER

Front Panel

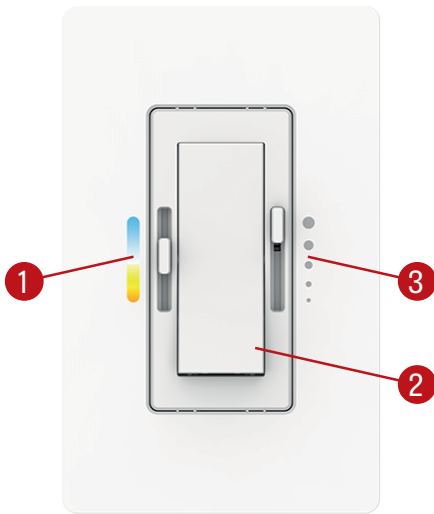

Controller image may differ

Dimensions

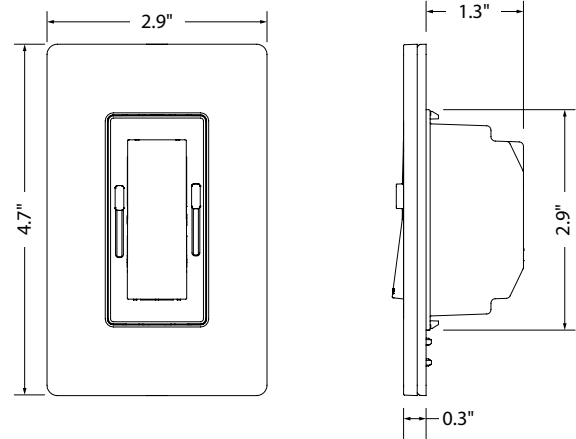

- (1) CCT control: Use this button to adjust the color temperature.
- (2) On/Off switch: Use this button to turn ON or OFF the fixture.
- (3) Dimming control: Use this button to adjust the brightness.

Wiring Diagram

