

VIA 3 PENDANT

DIRECT/INDIRECT, DIRECT, INDIRECT
STATIC WHITE, BIOS



Declare.



Lens Positions



SENSORS
For latest information on sensors, click [here](#).

Module Options

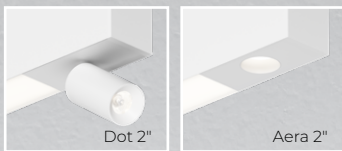

Our elegant, flexible Via family is composed of linear, pendant, surface, recessed, and wall mounted luminaires. Each lighting fixture can be installed as a discrete luminaire or in continuous runs or patterns. Via 3 Pendant is offered with Lambertian, asymmetric, widespread, wall wash, or low-glare optics.

DIRECT



INDIRECT



VIA 3 PENDANT



DIRECT/INDIRECT, DIRECT, INDIRECT
STATIC WHITE, BIOS

Project: _____

 Type: _____

Order Guide

LUMINAIRE ID	DISTRIBUTION	DIRECT OPTIC Specify NA for Indirect fixture	LENS POSITION Specify NA for Indirect fixture	INDIRECT OPTIC Specify NA for Direct fixture	LIGHT SOURCE ⁶
VIA3P					
VIA3P - Via 3" Pendant	DI - Direct/ Indirect D - Direct I - Indirect	HLO - High-Efficiency Lambertian Optic ARO2 - Asymmetric Refractive Optic WRO2 - Wall Wash Refractive Optic WDO - Widespread Direct Optic LGO - Low-Glare Optic MPO - Micro-Prismatic Optic NA - Not applicable	FH ¹ - Flush 0.5D ¹ - 0.5" drop 1.0D ¹ - 1.0" drop NA ¹ - Not applicable ¹ For HLO, specify FH, 0.5D, or 1.0D. ² For ARO2, WRO2, WDO, LGO, and MPO, specify FH. ³ For an Indirect fixture, specify NA.	WIO2 ² - Widespread Indirect Optic TIO ³ - Translucent Indirect Optic WAI2 ⁴ - Widespread Asymmetric Indirect Optic HLO ⁵ - High-Efficiency Lambertian Optic ARO2 ⁵ - Asymmetric Refractive Optic NA - Not applicable	SW - Static white BIOSST ^{7,8} - BIOS Biological Static BIOSDY ^{7,8} - BIOS Biological Dynamic BIOSTU ^{7,8} - BIOS Biological Tunable ⁶ Chromawerx SOLA, DUO, and QUADRO also available. Consult other spec sheets ⁷ Only available with low and medium lumen packages. ⁸ See page 8 for details.

CRI	DIRECT LUMEN PACKAGE Specify NA for Indirect fixture	INDIRECT LUMEN PACKAGE Specify NA for Direct fixture	COLOR TEMP.	LUMINAIRE LENGTH	VOLTAGE
80CRI - 80+ CRI 90CRI ⁹ - 90+ CRI ⁹ Not available with BIOS.	350LMF ¹⁰ - Hypo output 350 lm/ft 500LMF - Low output 500 lm/ft 750LMF - Medium output 750 lm/ft 1000LMF - High output 1000 lm/ft 1200LMF ¹¹ - Hyper output 1200 lm/ft NA - Not applicable ¹⁰ Minimum 3' fixture. ¹¹ Fixture will be very bright. Use in suitable applications.	350LMF - Hypo output 350 lm/ft 500LMF - Low output 500 lm/ft 750LMF - Medium output 750 lm/ft 1000LMF - High output 1000 lm/ft 1200LMF ¹¹ - Hyper output 1200 lm/ft NA - Not applicable	27K ¹² - 2700K 30K - 3000K 35K - 3500K 40K - 4000K 50K ¹² - 5000K ¹² Not available with BIOS.	#FT#IN ¹³ - Specify nominal length (#) in 1" and/or 1" increments Standard nominal lengths: Single units: 2' to 12' (up to 8' for MPO) Continuous runs: lengths over 12' (8' for MPO) ¹³ Minimum 3' for Direct/Indirect.	120V - 120V 277V - 277V UNV - 120V-277V 347V ¹⁴ - 347V ¹⁴ Available with D1 driver only.

DRIVER ¹⁵	ELECTRICAL	ELECTRICAL SECTIONS (optional) ^{22,23}	MOUNTING ²⁸
DI - 1% 0-10V DA ¹⁶ - DALI LDEI ¹⁶ - Lutron Hi-lume 1% Eco ELD1 - eldoLED 1% ECOdrive 0-10V ELDO - eldoLED 0.1% SOLOdrive 0-10V ELV ¹⁷ - ELV 120V TRI ¹⁷ - TRIAC 120V ¹⁵ PoE (Power-over-Ethernet) compatible. Consult factory for details. ¹⁶ On-site commissioning is required. ¹⁷ Available with 120V only.	1C - 1 circuit 2C ¹⁸ - 2 circuits #MC ¹⁹ - Multi circuit EC - Emergency-powered fixture NL - Night light fixture DL - Daylight fixture GTD ^{20,21} - Generator transfer device fixture ¹⁸ Available for Direct/Indirect only. Separate direct and indirect circuits. ¹⁹ Specify total number of circuits (#), including any required for electrical section or module options. Provide drawing or layout specifications. Minimum 4' section per circuit. ²⁰ Minimum 4' fixture. ²¹ Not available with 347V.	#EC## ²⁴ - Emergency-powered section #NL## ²⁴ - Night light section #DL## ²⁴ - Daylight section #GTD## ^{24,25,26} - Generator transfer device section #EMB ^{26,27} - Emergency battery NA - None ²² Specify with multi circuit (#MC) electrical option only. ²³ Provide drawing or layout specifications. Consult factory for other configurations. Default section length is 4'. ²⁴ Specify quantity (#), and section length in inches (##). ²⁵ Minimum 4' section. ²⁶ Not available with 347V. ²⁷ Specify quantity (#). All batteries will be on the same circuit. Each battery powers a 4' section. For Direct/Indirect, minimum 8' fixture.	ACS - Aircraft cable, standard STS - Stem, standard ACC() - Aircraft cable, custom STC() - Stem, custom ²⁸ Standard canopies are black for black fixtures, and white for all other finishes. See page 3 for full details on standard and custom options.

FINISH	CONTROL ^{29,30}	OPTIONS ³⁶	MODULE (optional) ³⁸
W - Matte white AL - Aluminum B - Matte black CF# - Custom finish, specify RAL#	STANDALONE CONTROLS ^{31,32} Specify the quantity (#) of sensors per fixture. #OMS ³³ - Onboard Occupancy #OMS## ³⁴ - Onboard Occupancy with bi-level dimming #ODS - Onboard Daylight #OCS - Onboard Occupancy & Daylight CONNECTED CONTROLS ³⁵ LU - Lutron AWNR - Lutron Athena Wireless Node RF Only AWNS - Lutron Athena Wireless Node Sensor ENC - Encelium WL - Cooper Wavelinx AN - Acuity nLight CA - Casambi LG - Legrand NA - None ²⁹ Standalone and connected control options cannot be combined. ³⁰ Available with flush lens option only. ³¹ Available with D1 driver and 1 circuit options only. ³² Minimum 4' per zone. Provide control zone length. ³³ Fixture turns off when no occupancy. ³⁴ Fixture dims to specified light level % (##). ³⁵ Consult factory for connected controls.	FUI20 - Fuse 120V FU277 - Fuse 277V CTB9 ³⁷ - T-bar caddy clip, 9/16" CTB15 ³⁷ - T-bar caddy clip, 15/16" CTG9 ³⁷ - Tegular caddy clip, 9/16" CTG15 ³⁷ - Tegular caddy clip, 15/16" CST ³⁷ - Screw slot caddy clip NA - None ³⁶ Separate codes with a "+" if more than one is specified. ³⁷ Available with aircraft cable only.	#DOT2M() - Dot 2" #AE2R() - Aera 2" Round Downlight NA - None ³⁸ See page 3 for ordering details. • Only available with static white. • Only available with flush lens. • Not available with EMB. • Consult factory for compatibility with controls.



VIA 3 PENDANT



DIRECT/INDIRECT, DIRECT, INDIRECT
STATIC WHITE, BIOS

Module Code

- For a module, specify the options in the parentheses.
- The light source is static white.
- CRI of module matches specification of main fixture.
- Minimum 4' fixture and minimum 2' section per module. Consult factory for other configurations.

Example: 1DOT2M(4IN-FTMB-SDB-FTMB-20DEG-1100LM-27K)

MODULE ^{1,2}	HEIGHT	CYLINDER FINISH	BAFFLE	BAFFLE FINISH	BEAM ANGLE	LUMEN PACKAGE	COLOR TEMP.
#DOT2M() - Dot 2" ¹ Specify quantity (#). ² 6" blank per module. Blank finish will match fixture finish.	4IN - 4"	FTMB - Matte black FTMW - Matte white CF# - Custom finish, specify RAL #	SDB - Standard baffle DCB ³ - Decorative baffle ³ Recommended when a different finish is desired for the baffle.	FTMB - Matte black FTMW - Matte white CF# - Custom finish, specify RAL #	20DEG - 20° Spot 35DEG - 35° Narrow flood 50DEG - 50° Wide flood	1100LM - 1100 lm, 15.9 W 1260LM - 1260 lm, 17.8 W	27K - 2700K 30K - 3000K 35K - 3500K 40K - 4000K

Example: 1AE2R(7W-10DEG-27K-SDL-FTMB)

MODULE ^{1,2,3}	WATTAGE	BEAM ANGLE	COLOR TEMP.	LENS AT BAFFLE	BAFFLE FINISH
#AE2R() - Aera 2" Round Downlight ¹ Specify quantity (#). ² 6" blank per module. Blank finish will match fixture finish. ³ Module is trimless.	7W - 7 W output, up to 714 lm 10W - 10 W output, up to 961 lm	10DEG - 10° very narrow spot 15DEG - 15° Narrow spot 25DEG - 25° Spot 35DEG - 35° Narrow flood 50DEG - 50° Wide flood	27K - 2700K 30K - 3000K 35K - 3500K 40K - 4000K 50K - 5000K	SDL - Soft diffused lens, solite FDL - Frosted diffused lens CL - Clear lens	FTMB - Matte black FTMW - Matte white FSPC - Satin silver FSSPC - Matte silver FCHP - Champagne FDBZ - Dark bronze CF# - Custom finish, specify RAL#

Pendant Mounting Code

Aircraft Cable

Standard

ACS - Aircraft cable, standard

- Ø 5" for power canopy
- Ø 3" for non-power canopy
- Canopies are black for black fixtures, and white for all other fixture finishes
- Power cord is black for black fixtures, and white for all other fixture finishes
- Aircraft cable length is 36"

Custom

Example: ACC(3NPC-72IN-W-PCB-NA)

ACC() - Aircraft cable, custom

NON-POWER CANOPY SIZE	AIRCRAFT CABLE LENGTH	CANOPY FINISH	POWER CORD COLOR	OPTION
3NPC - Ø 3" non-power canopy 5NPC - Ø 5" non-power canopy	36IN - 36" 72IN - 72" 120IN - 120" #IN ¹ - Other lengths, specify in inches ¹ Maximum length is 288". For longer lengths, please consult factory.	W - Matte white AL - Aluminum B - Matte black CF# - Custom finish, specify RAL#	PCW - White PCB - Black	SEM ² - Seismic mounting SLC ² - Sloped ceiling for aircraft cable NA - None ² Not available with the Ø 3" non-power canopy size.

Stem

Standard

STS - Stem, standard

- Ø 5" for power canopy
- Ø 5" for non-power canopy
- Canopies are black for black fixtures, and white for all other fixture finishes
- Stem finish is the same color as fixture
- Stem length is 18"
- Stem is not field adjustable

Custom

Example: STC(5NPC-36IN-W-STW-SLS)

STC() - Stem, custom

NON-POWER CANOPY SIZE	STEM LENGTH	CANOPY FINISH	STEM COLOR	OPTION
5NPC - Ø 5" non-power canopy	18IN - 18" 36IN - 36" #IN ³ - Specify length in inches ³ Minimum length is 6". Maximum length is 72". Stem is not field adjustable.	W - Matte white AL - Aluminum B - Matte black CF# - Custom finish, specify RAL#	STW - Matte white STAL - Aluminum STB - Matte black STCF# - Custom finish, specify RAL#	SLS - Sloped ceiling for stem NA - None

VIA 3 PENDANT



DIRECT/INDIRECT, DIRECT, INDIRECT
STATIC WHITE, BIOS

Dimensions

Flush Lens

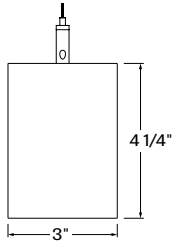

0.5" Drop Lens ¹

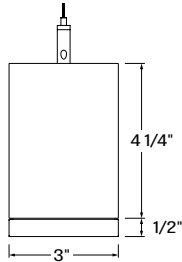

1.0" Drop Lens ¹

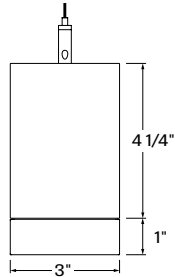

¹Only available with HLO direct lens.

VIA 3 PENDANT



DIRECT/INDIRECT, DIRECT, INDIRECT
 STATIC WHITE, BIOS

Photometrics

Values calculated based on a 4' fixture at 3500K for all optics.

DIRECT OPTICS

HLO (Flush lens)

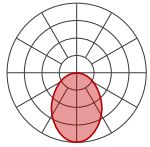

LM/FT	W/FT	LM/W
350	2.8	125
500	4.1	123
750	6.3	119
1000	8.6	116
1200	10.6	113

WRO2

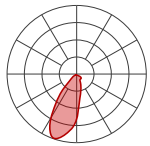

LM/FT	W/FT	LM/W
350	3.0	116
500	4.4	112
750	7.0	107
1000	9.8	102
1200	12.1	99

LGO

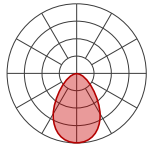

LM/FT	W/FT	LM/W
350	3.2	108
500	4.7	106
750	7.3	102
1000	10.2	98
1200	12.5	96

ARO2

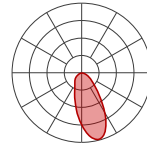

LM/FT	W/FT	LM/W
350	3.0	116
500	4.4	113
750	7.0	107
1000	9.7	103
1200	12.1	99

WDO

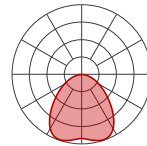

LM/FT	W/FT	LM/W
350	3.0	118
500	4.3	116
750	6.7	113
1000	9.2	109
1200	11.3	106

MPO

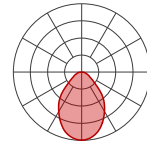

LM/FT	W/FT	LM/W
350	3.1	112
500	4.5	112
750	6.8	111
1000	9.5	105
1200	12.0	100

MULTIPLIER TABLES

Use these tables to get results for different color temperatures and lens positions for all photometric tables.

Multiplier - CCT/CRI

CCT	WATTS		LPW
	80+ CRI / 90+ CRI	80+ CRI / 90+ CRI	
2700K	1.05	0.95	
3000K	1.02	0.98	
3500K	1.00	1.00	
4000K	1.00	1.00	
5000K	0.96	1.04	

Multiplier - Lens position

DIRECT LENS	WATTS	LPW
Flush lens	1.00	1.00
Drop lens 0.5"	0.98	1.02
Drop lens 1.0"	0.96	1.04

DIRECT/INDIRECT - LPW CALCULATION

For Direct/Indirect performance values, follow the formula.

$$\left(\frac{\text{DIRECT LM/FT} + \text{INDIRECT LM/FT}}{\text{DIRECT W/FT} + \text{INDIRECT W/FT}} \right) = \text{LPW}$$

VIA 3 PENDANT



DIRECT/INDIRECT, DIRECT, INDIRECT
 STATIC WHITE, BIOS

Photometrics

Values calculated based on a 4' fixture at 3500K for all optics.

INDIRECT OPTICS

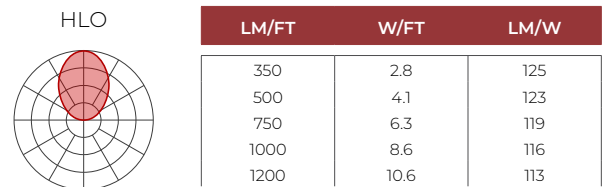
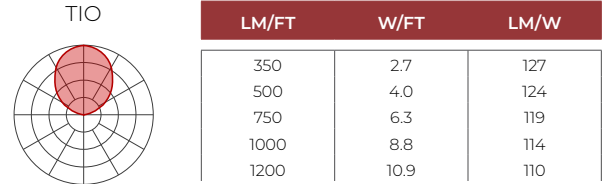
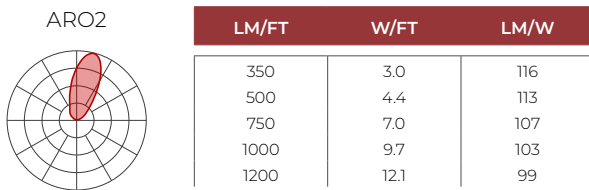
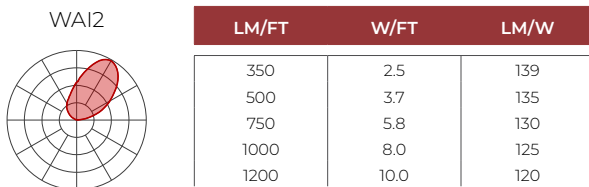
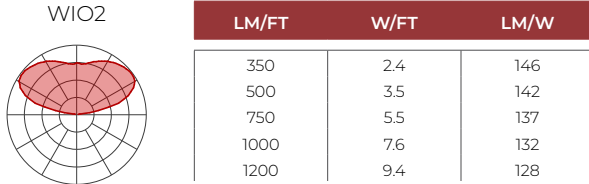

MULTIPLIER TABLES

Use this table to get results for different color temperatures for all photometric tables.

Multiplier - CCT/CRI

CCT	WATTS		LPW
	80+ CRI / 90+ CRI	80+ CRI / 90+ CRI	
2700K	1.05		0.95
3000K	1.02		0.98
3500K	1.00		1.00
4000K	1.00		1.00
5000K	0.96		1.04

DIRECT/INDIRECT - LPW CALCULATION

For Direct/Indirect performance values, follow the formula.

$$\left(\frac{\text{DIRECT LM/FT} + \text{INDIRECT LM/FT}}{\text{DIRECT W/FT} + \text{INDIRECT W/FT}} \right) = \text{LPW}$$

VIA 3 PENDANT



DIRECT/INDIRECT, DIRECT, INDIRECT
STATIC WHITE, BIOS

DOT 2" MODULE

Values calculated based on 3500K.

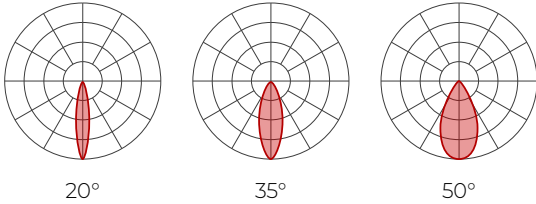

Delivered lumens (LM)

WATTAGE	LUMEN PACKAGE
15.9 W	1100
17.8 W	1260

Efficacy (LM/W)

WATTAGE	EFFICACY
15.9 W	69
17.8 W	71

Please follow the multiplier table to ensure correct lumen value.

CCT	
2700K	0.94
3000K	0.96
3500K	1
4000K	1.02

AERA 2" MODULE

Values calculated based on 3500K and SDL lens option.

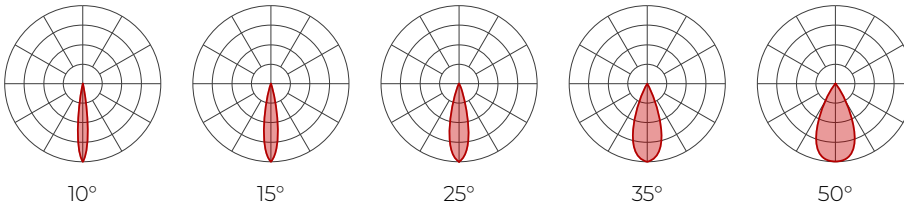

Delivered lumens (LM)

CRI	80+ CRI					90+ CRI				
	BEAM	10°	15°	25°	35°	50°	10°	15°	25°	35°
7 W	589	654	714	705	676	550	611	667	659	632
10 W	792	880	961	949	910	740	822	898	887	850

Efficacy (LM/W)

CRI	80+ CRI					90+ CRI				
	BEAM	10°	15°	25°	35°	50°	10°	15°	25°	35°
7 W	84	93	102	101	97	79	87	95	94	90
10 W	79	88	96	95	91	74	82	90	89	85

Please follow the multiplier tables to ensure correct lumen value.

CCT	
2700K	0.94
3000K	0.98
3500K	1
4000K	1.05
5000K	1.05

LENS AT BAFFLE	
SDL - Soft diffused lens, Solite	1
FDL - Frosted lens	0.8
CL - Clear lens	1.1

VIA 3 PENDANT



DIRECT/INDIRECT, DIRECT, INDIRECT
 STATIC WHITE, BIOS

BIOS

Three BIOS Circadian LED solutions are offered – Biological Static, Biological Dynamic, and Biological Tunable.
 Use the decision tree below to identify when and where to use BIOS Wellness LED Lighting Solutions.

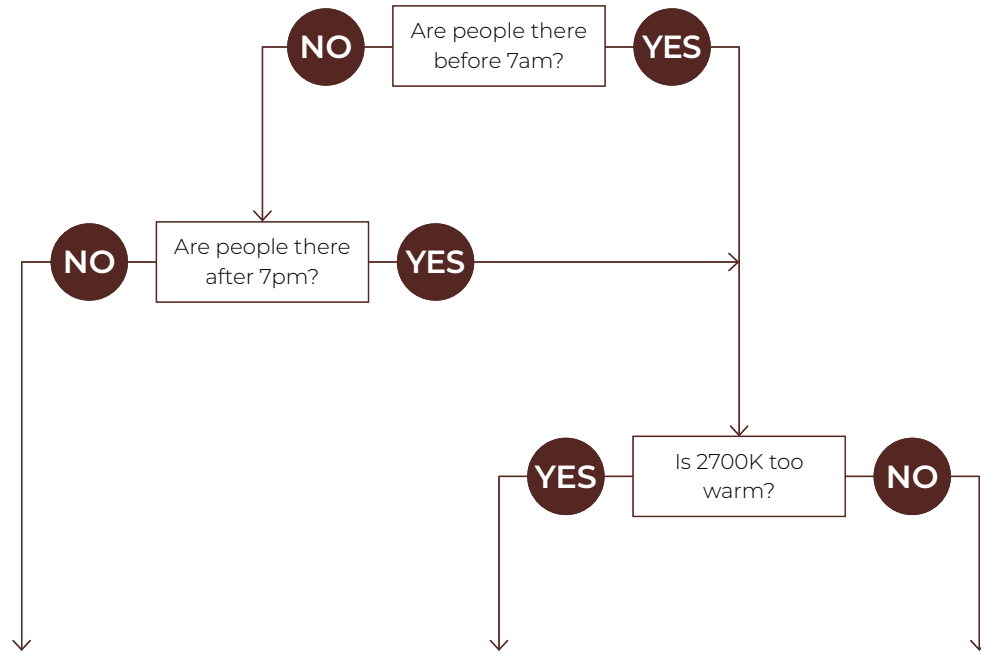

Biological Static BIOSST	Biological Dynamic BIOSDY	Biological Tunable BIOSTU
No CCT change when dimmed e.g. 40K - 4000K stays as 4000K when dimmed	500K shift when dimmed e.g. 40K - 4000K changes to 3500K when dimmed	Dims to 2700K e.g. 40K - 4000K changes to 2700K when dimmed
Daytime solution	Daytime + evening solution	Daytime + evening solution
Spaces in operation during daytime hours, between 7am and 7pm	Spaces in operation overnight, after 7pm and before 7am, and when CCT color shift in the evening is not preferred	Suitable for spaces in operation overnight, after 7pm and before 7am, and where people do not sleep (CCT color shift in the evening is preferred)
E.g. offices, medical/dental offices	E.g. hospitals	E.g. offices, shiftwork

VIA 3 PENDANT



DIRECT/INDIRECT, DIRECT, INDIRECT
STATIC WHITE, BIOS

Technical Specifications

DIRECT OPTICS

High-Efficiency Lambertian Optic (HLO)

The High-Efficiency Lambertian Optic (HLO) uses matte white reflectors to distribute LED output across 0.075" acrylic shielding, providing up to 88% transmission and good obscuration. Available with different lens position options, HLO has a spacing criterion of 1.10.

Asymmetric Refractive Optic (ARO2)

The Asymmetric Refractive Optic (ARO2) uses a sophisticated reflector combined with a matte beam-shaping film to create a smooth, effective downward light component without shadows or hot spots. It provides directional Gaussian light distribution with peak intensity at 20° above nadir and a 55° Full Width at Half Maximum (FWHM) beam angle. Microstructure material applied to the snap-in lens provides the precise refractive power and visual comfort, while achieving a high luminous efficacy.

Wall Wash Refractive Optic (WRO2)

The Wall Wash Refractive Optic (WRO2) delivers smooth vertical illumination with a gentle gradient and soft visual cut-off. Its exacting configuration creates a strong downward light component without shadows or hot spots and provides light distribution with peak intensity at 21° above nadir. Microstructure material applied to the snap-in lens provides the precise refractive power and visual comfort, while achieving a high luminous efficacy.

Widespread Direct Optic (WDO)

The Widespread Direct Optic (WDO) is designed to distribute light far and wide. As such, it has an excellent luminous efficacy, a light span that is 40% farther than that of our traditional HLO, and it maximizes spacing distance while still creating a sense of uniformity. The lens snaps into place and utilizes nano prismatic optics to mask the diodes that are actually emitting the light.

Low-Glare Optic (LGO)

The Low-Glare Optic (LGO) is designed to cut off high-angled light and control glare. The carefully crafted lens refracts light downward through its center from which it then disperses into a wide conical distribution that negates any illumination at about 40°. The LGO provides the visual comfort of a louver in a smooth acrylic lens.

Micro-Prismatic Optic (MPO)

The Micro-Prismatic Optic (MPO) delivers high-efficiency, low-glare illumination with UGR <17. Its precision-engineered lens, composed of thousands of tiny prisms, diffuses light to reduce glare, producing a ceiling plane that reads smooth from a distance while revealing subtle texture up close. The result is balanced, efficient illumination with a refined architectural presence.

INDIRECT OPTICS

Widespread Indirect Optic (WIO2)

The Widespread Indirect Optic (WIO2) is a horizontal LED array with a widespread indirect micro prismatic optic that offers an impressive 160° spread. WIO2 creates an even illumination for smooth brightness on the ceiling that can achieve uniformity ratios of up to 2:1.

Uniformity [max/min]

Based on 18' continuous runs, in a 20' x 40' room, 10' wall height

Mounting height from ceiling	Spacing (Center to center)		
	8'	10'	12'
12"	5.5	10.0	9.0
18"	3.5	6.0	6.0
24"	2.5	4.0	4.5

Translucent Indirect Optic (TIO)

The Translucent Indirect Optic (TIO) is composed of a horizontal LED array that has a translucent lens to mask pixilation from the diodes. TIO has a 100° spread in the indirect that is ideal when the fixture is mounted farther away from the ceiling.

Widespread Asymmetric Indirect Optic (WAI2)

The Widespread Asymmetric Indirect Optic (WAI2) offers an upward grazing effect with a 45° forward throw. It softly highlights the ceiling in the up-light while distributing the required illumination of the rest of an interior space. For avoiding glare and enjoying visual comfort, WAI2 is an ideal solution.

High-Efficiency Lambertian Optic (HLO)

The High-Efficiency Lambertian Optic (HLO) uses matte white reflectors to distribute LED output across 0.075" acrylic shielding, providing up to 88% transmission and good obscuration. HLO has a spacing criterion of 1.10.

Asymmetric Refractive Optic (ARO2)

The Asymmetric Refractive Optic (ARO2) uses a sophisticated reflector combined with a matte beam-shaping film to create a smooth, effective downward light component without shadows or hot spots. It provides directional Gaussian light distribution with peak intensity at 20° above nadir and a 55° Full Width at Half Maximum (FWHM) beam angle. Microstructure material applied to the snap-in lens provides the precise refractive power and visual comfort, while achieving a high luminous efficacy.

VIA 3 PENDANT



DIRECT/INDIRECT, DIRECT, INDIRECT
STATIC WHITE, BIOS

LIGHT SOURCE

Static white

Custom linear array of mid-flux LEDs are cartridge-mounted with quick-connect wiring to facilitate service and thermal management. Available in 2700K, 3000K, 3500K, 4000K, and 5000K with a minimum 80+ CRI and an option for 90+ CRI with elevated R9 value. Color consistency maintained to within 3 SDCM. All LEDs have been tested in accordance with IESNA LM-80-08 and the results have shown L80 lumen maintenance greater than 60,000 hours. Absolute product photometry is measured and presented in accordance with IESNA LM-79, unless otherwise indicated.

BIOS

BIOS SkyBlue™ Technology is designed to provide the specific circadian stimulus to improve overall sleep quality, recovery during the night, and overall feelings of well-being. The non-visual light signals that stimulate our circadian system have peak intensity in the "sky blue" region. As the diagram below illustrates, BIOS SkyBlue technology shifts the peak LED spectral intensity (490 nm) to align better with the peak response of circadian stimulus. Also note the enhanced deep-red (near 660 nm) spectrum.

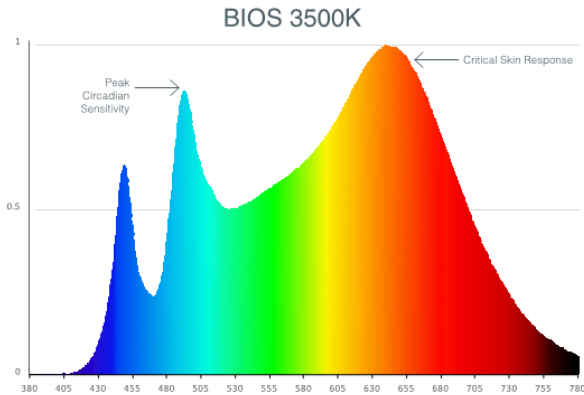

Three BIOS solutions are offered: BIOS Biological Static (BIOSST), BIOS Biological Dynamic (BIOSDY), and BIOS Biological Tunable (BIOSTU). See page 8 for details.

LUMINAIRE LENGTH

Via 3 is available in standard lengths of 2' to 12' (up to 8' for MPO). Continuous runs are available for run lengths over 12' (8' for MPO). Exact run length must be noted in the product code. The minimum length is 2' for Direct or Indirect fixtures, and 3' for Direct/Indirect fixtures. Lengths can be ordered in 1' and/or 1" increments. All individual sections are joined together onsite using the joiner kits provided. Lumenwerx offers joiner kits that are extremely simple to work with in the field and result in a fixture that appears virtually seamless with no light leak at any connection.

ELECTRICAL

Factory-set, adjustable output current LED driver with universal (120-277 VAC) input. Dimmable from 100% to 1% with 0-10V dimming control. Rated life (90% survivorship) of 50,000 hours at 50°C max. ambient (and 70°C max. case) temperature. At maximum driver load: Efficiency > 84%, PF > 0.9, THD < 20%. Other specifiable options include Lutron Hi-Lume 1% Eco, eldoLED 1% ECOdrive 0-10V, eldoLED 0.1% SOLOdrive 0-10V, ELV, TRIAC, and DALI protocol drivers. All of our standard 0-10V drivers are NEMA 410 compliant. ELV and TRIAC dimming performance (including minimum dimming percentage) subject to dimmer selection.

PoE

Depending on the PoE manufacturer selected, Lumenwerx will install the node in factory as either integral to the luminaire or as a remote module. Factory programming of the PoE node may or may not enable the following functionalities: lumen package, DUO (tunable white), QUADRO (RGBW), emergency battery backup, and sensor integration. These must be addressed and evaluated on a case-by-case basis.

ELECTRICAL SECTION OPTIONS

Electrical section options are available for fixtures specified as multi circuit (#MC). With MC, specify the total number of circuits (#), including any circuits required for optional electrical sections. A drawing is required to specify the layout. Please consult factory for custom configurations.

Electrical sections

Options include emergency-powered (#EC##), night light (#NL##), daylight (#DL##), and generator transfer device (#GTD##) sections. Specify the quantity (#), as well as the section length in inches (##).

Example 1: A 32' Direct fixture with two 8' emergency-powered sections on a second circuit.

Code: 2MC-2EC96

Example 2: A 16' Direct/Indirect fixture with separate circuits for direct and indirect, and with one 4' night light section on the direct side on a third circuit.

Code: 3MC-1NL48

VIA 3 PENDANT



DIRECT/INDIRECT, DIRECT, INDIRECT
STATIC WHITE, BIOS

Example 3: A 24' Direct fixture with one 4' generator transfer device section.

Code: 1MC-1GTD48

Battery

Each emergency battery (#EMB) powers a 4' section. All batteries will be on the same circuit. Specify the number of batteries (#) required.

Factory installed long life, high temperature, maintenance-free Lithium-Ion battery pack with self-test functionality, test switch and charge indicator. Minimum of 90 minutes operation, up to 1000 lumens per 4' (25°C) emergency lighting output and recharge time of 24 hours.

MOUNTING

Pendant fixtures can be mounted either with aircraft cable or with stem. See page 3 for details.

FINISH

Interior: 95% reflective matte powder coated white paint

Exterior: Matte white, matte black, or aluminum powder coating. Custom finishes are also available.

CONTROLS

Lumenwerx offers several options for integrating occupancy and daylight harvesting controls in our luminaires.

For latest information on sensors, click [here](#).



Standalone controls

An integrated standalone sensor controls the luminaire in which it is installed. Depending on the length, more than one sensor may be necessary and may control the entire luminaire, or just a section of it. These controls operate independently. Unless otherwise agreed, sensor location, blank size, and functionality of the sensor within the luminaire are selected by Lumenwerx. See client drawings for details.

Three types are available:

OMS: An integral Passive InfraRed (PIR) sensor turns luminaires on and off automatically with field-adjustable time out period. No wall control is used. Coverage pattern for large motion has a 12' diameter with the sensor mounted 8' above the floor; for small motion, the pattern has an 8' diameter. Typically, one sensor is required for every 10' of a continuous luminaire run.

ODS: An integral, daylight harvesting sensor with closed-loop operation dims the luminaire in which it is installed in order to compensate for available daylight. The sensor measures the combination of daylight and luminaire light reflected from horizontal surfaces below the luminaire. Initial onsite calibration is required via the use of provided remote control.

OCS: Both an occupancy and a daylight sensor are installed in the luminaire.

Connected controls

With connected controls, sensors or nodes installed in the luminaire form part of a larger control system infrastructure from manufacturers such as: Lutron, Encelium, Cooper Wavelinx, Acuity nLight, Casambi, Legrand, and others. These connected controls allow for a scalable system providing features like occupancy and daylight control, manual control, scheduling and configuration of various zones and scenes. Energy reporting and system monitoring are also possible. Specific capabilities depend on the control system being used.

Lumenwerx installs the components (sensors, nodes, power packs, etc) which may be supplied to us by a third party, or procured directly by Lumenwerx, depending on the control system manufacturer.

Lumenwerx is solely responsible for the installation of specified components; the controls manufacturer is responsible for performance of the control system.

To indicate a Lumenwerx luminaire with connected controls, identify the specific onsite control system to be integrated into the luminaires using the ordering code. Due to the diversity of components, you must contact factory to assure complete compatibility with intended control system and to fully specify the luminaire.

Complete control specifications, sensor/node/power pack layout, and narrative for the control system are required for Lumenwerx to create shop drawings and submittals.

VIA 3 PENDANT



DIRECT/INDIRECT, DIRECT, INDIRECT
 STATIC WHITE, BIOS

DOT MODULE

Dot is a round spotlight that rotates 360° and tilts 90°, available in three beam angles of 20°, 35°, and 50°. LED light source CCT options are 2700K, 3000K, 3500K, and 4000K available in either 80+ CRI or 90+ CRI. Offered in 4" height with two baffle options: standard and decorative. Dot is available in a white, black, or custom finish.

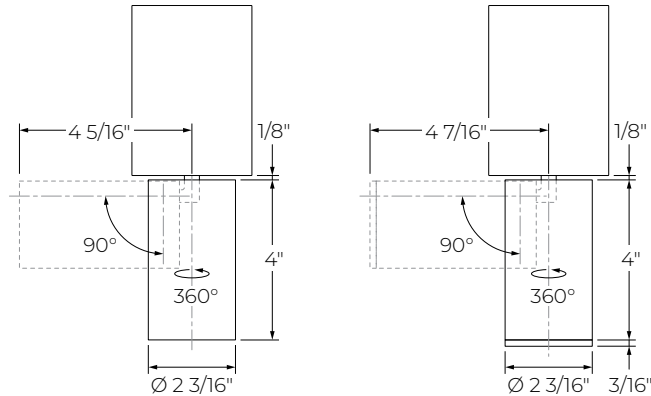

Dot 2" - Standard baffle

Dot 2" - Decorative baffle

AERA MODULE

Aera Downlight is available in five beam angles of 10°, 15°, 25°, 35°, and 50°. LED light source CCT options are 2700K, 3000K, 3500K, 4000K, and 5000K available in either 80+ CRI or 90+ CRI. Aera Downlight is available in a wide range of colors.

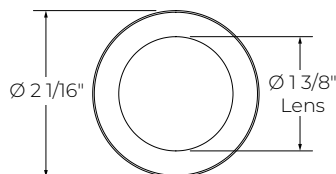

Aera 2"

CONSTRUCTION

- Housing:** Extruded aluminum, up to 90% recycled content
- Interior brackets:** Die-formed cold rolled sheet steel
- Joining system:** Die-cast zinc
- Reflectors:** Die-formed cold rolled steel, 95% reflective matte white painted
- Lens:** Acrylic
- Drop lens:** Extruded with glued end caps
- End caps:** Die-cast aluminum
- Hanger:** Chromed griplock securely attached in end caps and/or joiners with stainless steel hardware
- Aircraft cable suspension:** Ø 1/16" stainless steel aircraft cable
- Stem:** Ø 1/2" threaded steel tube

WEIGHT

Direct/Indirect	Direct or Indirect
4': 13.23 lbs - 6.0 kg	4': 11.12 lbs - 5.05 kg
8': 26.48 lbs - 12.0 kg	8': 22.25 lbs - 10.1 kg
12': 39.84 lbs - 18.0 kg	12': 33.48 lbs - 15.2 kg

CERTIFICATIONS

- ETL:** Rated for indoor dry/damp locations. Conforms to UL Standard 1598 and certified to CAN/CSA Standard C22.2 No. 250.0.
- Declare:** [LBC Red List Approved](#)

WARRANTY

Lumenwerx provides a five-year limited warranty on electrical and mechanical performance of the luminaires, including the LED boards, drivers, and auxiliary electronics. Lumenwerx will repair or replace defective luminaires or components at our discretion, provided they have been installed and operated in accordance with our specifications. Other limitations apply, please refer to the full warranty on our website.